

MASTECH®



CATALOGUE 2025

MEASURING INSTRUMENTS CATALOGUE

CONTENT INDEX

2	ABOUT MASTECH
4	FAST SELECTION CHARTS
34	DIGITAL MULTIMETERS
89	DIGITAL CLAMP METERS
123	AC LINE SPLITTERS
127	ELECTRICAL TESTERS
132	CIRCUIT TESTERS
137	CIRCUIT ANALYZERS
141	WIRE & CABLE TESTERS
148	LCR METERS
154	EARTH RESISTANCE
157	INSULATION TESTERS
161	THERMOMETERS
174	ENVIRONMENTAL METERS
198	INDUSTRIAL TESTERS
206	ACCESSORIES

About **MASTECH**[®]

At **MASTECH**, we believe that every measurement matters.

Whether you're a professional electrician diagnosing complex systems or a hobbyist working on a DIY project, having the right testing tools can make all the difference.

That's why we are committed to providing high-quality testing tools designed for accuracy, durability, and affordability—**empowering professionals and hobbyists alike.**

For nearly four decades, **MASTECH** has built a reputation for reliable, precision-engineered tools that deliver trustworthy results.

Our dedication to affordability does not mean cutting corners. It means maximizing value—crafting tools with advanced technology, robust materials, and intuitive designs that make testing simpler, faster, and more reliable.

We bridge the gap between premium quality and affordability, proving that exceptional tools don't have to come with a high price tag.



No matter the challenge, you deserve tools that perform with precision and reliability. **MASTECH** stands by you with tools you can trust.

Why **MASTECH**® ?

Built for Professionals & DIYers

Designed to support electricians, engineers, technicians, and hobbyists, making testing accessible to everyone.

Accuracy You Can Rely On

Precision-engineered tools for consistent, trustworthy results.

Affordable Excellence

Professional-grade performance at accessible prices.

MASTECH – Reliable Testing Tools for Every Budget.









DIGITAL MULTIMETERS MANUAL RANGING

CAT II
CAT III
CAT IV



Model	MAS830B	MAS830L	MAS838	MS8233A	MS8233B	MS8233C	MS8238
Page	35	36	37	38	39	40	41
Safety Rating	CAT II 600V	CAT II 600V	CAT II 600V	CAT III 600V	CAT III 600V	CAT III 600V	CAT II 600V
Display Counts	2000	2000	2000	2000	2000	2000	2000
True RMS							
NCV					•	•	
DC Voltage	600V	600V	600V	600V	600V	600V	600V
AC Voltage	600V	600V	600V	600V	600V	600V	600V
DC Current	10A	10A	10A	10A	10A	10A	10A
AC Current							
Temperature Measurement			-20~1000°C			-20~1000°C -4~1832°F	
Resistance	2MΩ	2MΩ	2MΩ	2MΩ	2MΩ	2MΩ	2MΩ
Capacitance							
Diode	•	•	•	•	•	•	•
Continuity		•	•	•	•	•	•
hFE Transistor Test		•					
Frequency							
Duty Cycle							
Square Wave Output							
Low Pass Filter							
Low Impedance							
Battery Test							•
Inductance							
Bar Graph							
V.F.C							
Dual Display							
Relative Measurement							
MAX/MIN/AVG							
Data Hold	•	•	•	•	•	•	•
Flashlight							
Display Backlight		•			•	•	
Auto Power Off							
Power Supply	9V 6F22*1	9V 6F22*1	9V 6F22*1	9V 6F22*1	9V 6F22*1	9V 6F22*1	9V 6F22*1

DIGITAL MULTIMETERS
MANUAL RANGING

						
CAT II CAT III CAT IV						
Model	MS8261	MS8264	MS8269	MS830M	MS830N	MS830T
Page	42	43	44	45	46	47
Safety Rating	CAT III 600V CAT II 1000V	CAT III 600V CAT II 1000V	CAT III 600V CAT II 1000V	CAT III 600V	CAT III 600V	CAT III 600V
Display Counts	2000	2000	2000	2000	2000	2000
True RMS						•
NCV					•	•
DC Voltage	1000V	1000V	1000V	600V	600V	600V
AC Voltage	750V	750V	750V	600V	600V	600V
DC Current	10A	10A	10A	10A	10A	10A
AC Current	10A	10A	10A			10A
Temperature Measurement		-20~1000°C	-20~1000°C			-20~1000°C
Resistance	200MΩ	200MΩ	20MΩ	200MΩ	20MΩ	200MΩ
Capacitance	20μF	20μF	200μF			200μF
Diode	•	•	•	•	•	•
Continuity	•	•	•	•	•	•
hFE Transistor Test	•	•	•		•	
Frequency		20KHz				2KHz
Duty Cycle						
Square Wave Output						
Low Pass Filter						
Low Impedance						
Battery Test					•	•
Inductance			20H			
Bar Graph						
V.F.C						
Dual Display						
Relative Measurement						
MAX/MIN/AVG						
Data Hold	•	•	•	•	•	•
Flashlight						
Display Backlight	•	•		•	•	•
Auto Power Off	•	•	•	•	•	•
Power Supply	9V 6F22*1	9V 6F22*1	9V 6F22*1	1.5V AAA*2	1.5V AAA*2	1.5V AAA*2







DIGITAL MULTIMETERS MANUAL RANGING

CAT II
CAT III
CAT IV



Model	MS850A	MS850B	MS890A	MS890B	MS890C+	MS890D+
Page	48	49	50	51	52	53
Safety Rating	CAT III 600V	CAT III 600V	CAT IV 600V CAT III 1000V	CAT IV 600V CAT III 1000V	CAT IV 600V CAT III 1000V	CAT IV 600V CAT III 1000V
Display Counts	2000	2000	2000	4000	6000	4000
True RMS	•	•	•	•	•	•
NCV	•	•		•	•	•
DC Voltage	600V	600V	1000V	1000V	1000V	1000V
AC Voltage	600V	600V	750V	750V	750V	750V
DC Current	10A	10A	10A	20A	10A	20A
AC Current	10A	10A	10A	20A	10A	20A
Temperature Measurement		-20~1000°C -4~1832°F	-20~1000°C		-20~1000°C 0~1800°F	-20~1000°C 0~1800°F
Resistance	200MΩ	20MΩ	200MΩ	40MΩ	60MΩ	40MΩ
Capacitance			200μF	40mF	60mF	40mF
Diode	•	•	•	•	•	•
Continuity	•	•	•	•	•	•
hFE Transistor Test	•		•	•		•
Frequency			200KHz	1KHz	10MHz	1KHz
Duty Cycle					•	
Square Wave Output					•	
Low Pass Filter						
Low Impedance					•	
Battery Test	•	•				
Inductance						
Bar Graph					•	
V.F.C					•	
Dual Display						
Relative Measurement		•	•	•	•	•
MAX/MIN/AVG		MAX/MIN				
Data Hold	•	•	•	•	•	•
Flashlight	•	•	•	•	•	•
Display Backlight	•	•	•	•	•	•
Auto Power Off	•	•	•	•	•	•
Power Supply	1.5V AAA*2	1.5V AAA*2	9V 6F22*1	1.5V AA*2	1.5V AA*2	1.5V AA*2

DIGITAL MULTIMETERS
MANUAL RANGING

						
	CAT II CAT III CAT IV					
Model	MY60	MY61	MY62	MY63	MY64	MY65
Page	54	55	56	57	58	59
Safety Rating	CAT III 600V CAT II 1000V	CAT III 600V CAT II 1000V	CAT III 600V CAT II 1000V	CAT III 600V CAT II 1000V	CAT III 600V CAT II 1000V	CAT III 600V CAT II 1000V
Display Counts	2000	2000	2000	2000	2000	20000
True RMS						
NCV						
DC Voltage	1000V	1000V	1000V	1000V	1000V	1000V
AC Voltage	750V	750V	750V	750V	750V	750V
DC Current	10A	10A	10A	10A	10A	10A
AC Current	10A	10A	10A	10A	10A	10A
Temperature Measurement			-20~1000°C		-20~1000°C	
Resistance	200MΩ	200MΩ	200MΩ	200MΩ	200MΩ	200MΩ
Capacitance		100μF	100μF	100μF	100μF	100μF
Diode	•	•	•	•	•	•
Continuity	•	•	•	•	•	•
hFE Transistor Test	•	•	•	•	•	•
Frequency				20kHz	20kHz	20kHz
Duty Cycle						
Square Wave Output						
Low Pass Filter						
Low Impedance						
Battery Test						
Inductance						
Bar Graph						
V.F.C						
Dual Display						
Relative Measurement						
MAX/MIN/AVG						
Data Hold	•	•	•	•	•	•
Flashlight						
Display Backlight						
Auto Power Off	•	•	•	•	•	•
Power Supply	9V 6F22*1	9V 6F22*1	9V 6F22*1	9V 6F22*1	9V 6F22*1	9V 6F22*1





DIGITAL MULTIMETERS AUTO RANGING

CAT II
CAT III
CAT IV







Model	MS8217	MS8221C	MS8233E	MS8239C	MS8239D+
Page	60	61	62	63	64
Safety Rating	CAT III 600V CAT II 1000V	CAT III 600V	CAT III 600V	CAT III 600V	CAT III 600V
Display Counts	4000	2000	2000	4000	4000
True RMS					•
NCV			•		•
DC Voltage	1000V	600V	600V	600V	600V
AC Voltage	1000V	600V	600V	600V	600V
DC Current	10A	10A	10A	10A	10A
AC Current	10A	10A	10A	10A	10A
Temperature Measurement	-55~1000°C	-20~1000°C	-20~1000°C -4~1832°F	-20~1000°C -4~1832°F	
Resistance	40MΩ	20MΩ	20MΩ	40MΩ	40MΩ
Capacitance	100μF	1000μF		100μF	40mF
Diode	•	•	•	•	•
Continuity	•	•	•	•	•
hFE Transistor Test		•			
Frequency	100kHz			10MHz	10MHz
Duty Cycle				•	
Square Wave Output					
Low Pass Filter					
Low Impedance					
Battery Test					
Inductance					
Bar Graph					
V.F.C					
Dual Display					
Relative Measurement	•				•
MAX/MIN/AVG			MAX		MAX/MIN
Data Hold	•		•	•	•
Flashlight					
Display Backlight			•	•	•
Auto Power Off	•	•	•	•	•
Power Supply	1.5V AAA*3	1.5V AAA*3	9V 6F22*1	1.5V AAA*2	1.5V AAA*2







DIGITAL MULTIMETERS
AUTO RANGING

					
	CAT II CAT III CAT IV				
Model	MS8239T	MS8251A	MS8251B	MS8268	MS8340A
Page	65	66	67	68	69
Safety Rating	CAT III 600V	CAT IV 600V CAT III 1000V	CAT IV 600V CAT III 1000V	CAT III 600V CAT II 1000V	CAT III 1000V
Display Counts	4000	6600	6600	4000	6000
True RMS	•		•		
NCV	•	•	•		
DC Voltage	600V	1000V	1000V	1000V	1000V
AC Voltage	600V	1000V	1000V	750V	750V
DC Current	10A	10A	10A	10A	10A
AC Current	10A	10A	10A	10A	10A
Temperature Measurement	-20~750°C -4~1832°F	0~1000°C 32~1832°F	0~1000°C 32~1832°F		-10~700°C 14~1292°F
Resistance	40MΩ	66MΩ	66MΩ	40MΩ	60MΩ
Capacitance	40mF	66mF	66mF	200μF	400μF
Diode	•	•	•	•	•
Continuity	•	•	•	•	•
hFE Transistor Test				•	
Frequency	10MHz	66MHz	66MHz	200kHz	10MHz
Duty Cycle		•	•	•	•
Square Wave Output					
Low Pass Filter					•
Low Impedance			•		
Battery Test					
Inductance					
Bar Graph		•	•		
V.F.C					
Dual Display		•	•		
Relative Measurement	•	•	•	•	•
MAX/MIN/AVG	MAX/MIN	MAX/MIN	MAX/MIN		MAX/MIN
Data Hold	•	•	•	•	•
Flashlight					
Display Backlight	•	•	•	•	•
Auto Power Off	•	•	•	•	•
Power Supply	1.5V AAA*2	9V 6F22*1	9V 6F22*1	1.5V AAA*3	1.5V AA*4

DIGITAL MULTIMETERS AUTO RANGING

				
CAT II CAT III CAT IV				
Model	MS850C	MS850D	MY68	MY78
Page	70	71	72	73
Safety Rating	CAT III 600V	CAT III 600V	CAT III 600V CAT II 1000V	CAT III 600V
Display Counts	4000	6000	4000	4000
True RMS	•	•		
NCV	•	•		
DC Voltage	600V	600V	1000V	600V
AC Voltage	600V	600V	750V	600V
DC Current	10A	10A	10A	10A
AC Current	10A	10A	10A	10A
Temperature Measurement		-20~1000°C -4~1832°F		
Resistance	40MΩ	60MΩ	40MΩ	40MΩ
Capacitance	100mF	100mF	200μF	200μF
Diode	•	•	•	•
Continuity	•	•	•	•
hFE Transistor Test	•	•	•	•
Frequency	10MHz	10MHz	200kHz	200kHz
Duty Cycle	•	•		•
Square Wave Output				
Low Pass Filter				
Low Impedance				
Battery Test	•			
Inductance				
Bar Graph				
V.F.C				
Dual Display				
Relative Measurement	•	•		•
MAX/MIN/AVG	MAX/MIN	MAX/MIN		
Data Hold	•	•	•	•
Flashlight	•	•		
Display Backlight	•	•		
Auto Power Off	•	•	•	•
Power Supply	1.5V AAA*2	1.5V AAA*2	9V 6F22*1	9V 6F22*1

DIGITAL MULTIMETERS
POCKET/PEN TYPE

							
	CAT II CAT III CAT IV						
Model	M320	M830B	M830BZ	M832	M838	MS8211	MS8211D
Page	74	75	76	77	78	79	80
Safety Rating	CAT III 300V CAT II 600V	CAT II 600V	CAT II 600V	CAT II 600V	CAT II 600V	CAT II 600V	CAT II 600V
Display Counts	4000	2000	2000	2000	2000	2000	2000
Auto Ranging	•					•	•
True RMS							
NCV						•	
DC Voltage	600V	600V	600V	600V	600V	600V	600V
AC Voltage	600V	600V	600V	600V	600V	600V	600V
DC Current	400mA	10A	10A	10A	10A		200mA
AC Current	400mA						200mA
Temperature Measurement	-20~1370°C						
Resistance	40MΩ	2MΩ	2MΩ	2MΩ	2MΩ	20MΩ	20MΩ
Capacitance	100μF						
Diode	•	•	•	•	•	•	•
Continuity	•		•	•	•	•	•
hFE Transistor Test		•		•	•		
Frequency	100kHz						
Duty Cycle							
Square Wave Output							
Low Pass Filter							
Low Impedance							
Battery Test							
Inductance							
Logic Level Test							•
Retractable Trip						•	•
Double Molding							
Relative Measurement							
MAX/MIN/AVG						MAX	MAX
Data Hold	•					•	•
Flashlight							
Display Backlight							
Auto Power Off	•					•	•
Power Supply	2*1.5V 357A(LR44)	9V 6F22*1	9V 6F22*1	9V 6F22*1	9V 6F22*1	1.5V AAA*2	1.5V AAA*2

**DIGITAL MULTIMETERS
POCKET/PEN TYPE**

CAT II
CAT III
CAT IV



Model	MS8212A	MS8223A
Page	81	82
Safety Rating	CAT III 600V	CAT III 600V
Display Counts	2000	2000
Auto Ranging	•	•
True RMS		
NCV	•	•
DC Voltage	600V	600V
AC Voltage	600V	600V
DC Current	200mA	200mA
AC Current	200mA	200mA
Temperature Measurement		
Resistance	20MΩ	20MΩ
Capacitance		
Diode	•	•
Continuity	•	•
hFE Transistor Test		
Frequency		
Duty Cycle		
Square Wave Output		
Low Pass Filter		
Low Impedance		
Battery Test		
Inductance		
Logic Level Test	•	•
Retractable Trip		
Double Molding	•	•
Relative Measurement		
MAX/MIN/AVG	MAX	MAX
Data Hold	•	•
Flashlight		
Display Backlight		
Auto Power Off	•	•
Power Supply	1.5V AAA*2	1.5V AAA*2





**DIGITAL MULTIMETERS
BENCH TYPE**

CAT II
CAT III
CAT IV









Model	MS8040
Page	83
Safety Rating	CAT II 1000V
Display Counts	22000
Auto Ranging	•
True RMS	•
DC Voltage	1000V
AC Voltage	750V
DC Current	10A
AC Current	10A
Temperature Measurement	-30~1300°C -22~2372°F
Resistance	200MΩ
Capacitance	20mF
Diode	•
Continuity	•
hFE Transistor Test	
Frequency	
Logic Frequency	220MHz
Linear Frequency	100kHz
Duty Cycle	•
Bar Graph	•
Relative Measurement	•
Peak Measurement	•
Low Pass Filter	•
DC Current (For Clamp)	220/2200A
AC Current (For Clamp)	220/2200A
MAX/MIN/AVG	MAX/MIN
Data Hold	•
Data Logging	
Analysis Software	
Interface	RS232
Display Backlight	•
Auto Power Off	•
Power Supply	220V/110V AC







DIGITAL MULTIMETERS
SPECIAL APPLICATION

					
CAT II CAT III CAT IV					
Model	MS5208	MS8229	MS8236	MS8239D	MS8265
Page	84	85	86	87	88
Safety Rating	CAT IV 600V CAT III 1000V	CAT III 600V	CAT III 600V	CAT III 600V	CAT III 600V CAT II 1000V
Display Counts	6600	4000	2000	2000	20000
Auto Ranging	•	•	•	•	•
True RMS	•				
NCV			•		
DC/AC Voltage	1000V/750V	1000V/750V	600V/600V	600V/600V	1000V/750V
DC/AC Current	400mA/400mA	10A/10A	10A/10A	10A/10A	10A/10A
Temperature Measurement	-30~1300°C -22~2372°F	-20~1000°C -4~1832°F			
Resistance	66MΩ	40MΩ	20MΩ	40MΩ	200MΩ
Capacitance	66mF	100μF			200μF
Diode	•	•	•	•	•
Continuity	•	•	•	•	•
hFE Transistor Test					•
Frequency	10kHz	200kHz			20kHz
Duty Cycle	•				
Relative Measurement	•				
MAX/MIN/AVG	MAX/MIN/AVG		MAX	MAX	
Data Hold	•	•	•	•	•
Low Pass Filter	•				
Insulation Test	1000V/2GΩ				
DAR/PI	•				
Relative Humidity		20~95%			
Sound Level		40~100dB			
Luminosity		4000/40000Lux			
Environment Temperature		0~40°C/32~104°F			
Cable Check			RJ11/RJ45/Tone		
Sound & Light Warning		•			•
Data Logging	100 Groups				
DWELL / TACH Test				•	
Display Backlight	•	•	•	•	•
Auto Power Off	•	•	•	•	•
Power Supply	1.5V AA*4	1.5V AAA*3	9V 6F22*2	1.5V AAA*2	9V 6F22*1

DIGITAL CLAMP METERS
AC CURRENT

							
Model	M266	M266C	M266F	MS2000G	MS2001	MS2001F	MS2003A
Page	90	91	92	93	94	95	96
Safety Rating	CAT III 600V CAT II 1000V	CAT III 600V CAT II 1000V	CAT III 600V CAT II 1000V	CAT II 1000V	CAT III 600V CAT II 1000V	CAT III 600V CAT II 1000V	CAT III 600V
Display Counts	2000	2000	2000	2000	2000	2000	4000
Jaw Size	Φ50mm 2.0"	Φ50mm 2.0"	Φ50mm 2.0"	Φ55mm 2.2"	Φ42mm 1.7"	Φ42mm 1.7"	19mm
Auto Ranging							•
True RMS							•
NCV							•
DC Voltage	1000V	1000V	1000V	1000V	1000V	1000V	600V
AC Voltage	750V	750V	750V	750V	750V	750V	600V
DC Current							
AC Current	1000A	1000A	1000A	2000A	1000A	1000A	200A
Temperature Measurement		0~750°C 32~1382°F		0~750°C 32~1382°F			-20°C~1000°C -4°F~1832°F
Resistance	20kΩ	2MΩ	2MΩ	2MΩ	2000Ω	2000Ω	40MΩ
Capacitance							4mF
Diode			•	•	•	•	•
Continuity	•	•	•	•	•	•	•
Frequency			2kHz	20kHz		2kHz	10MHz
Duty Cycle							
Small Current Measurement							
Inrush Current							
Insulation Test	2000MΩ	2000MΩ	2000MΩ				
Low Impadance							
Low Pass Filter (ACV)							
Bar Graph							
V.F.C							
Relative Measurement							•
MAX/MIN/AVG							MAX/MIN
Data Hold	•	•	•	•	•	•	•
Flashlight							
Display Backlight				•	•		•
Auto Power Off							•
Power Supply	9V 6F22*1	9V 6F22*1	9V 6F22*1	9V 6F22*1	9V 6F22*1	9V 6F22*1	1.5V AAA*2

DIGITAL CLAMP METERS
AC CURRENT

							
Model	MS2003B	MS2008B	MS2009A	MS2009C	MS2015A	MS2028A	MS2030
Page	97	98	99	100	101	102	103
Safety Rating	CAT III 600V	CAT III 600V	CAT III 600V	CAT III 600V	CAT IV 600V CAT III 1000V	CAT III 600V	CAT III 600V
Display Counts	6000	4000	2000	6000	6000	2000	2000
Jaw Size	19mm	Φ26mm 1.0"	Φ26mm 1.0"	Φ26mm 1.0"	Φ40mm 1.6"	Φ26mm 1.0"	Φ28mm 1.1"
Auto Ranging	•	•	•	•	•	•	
True RMS	•				•	•	
NCV	•		•	•	•		
DC Voltage	600V	600V	600V	600V	1000V	600V	600V
AC Voltage	600V	600V	600V	600V	750V	600V	600V
DC Current							
AC Current	200A	600A	600A	600A	1000A	600A	400A
Temperature Measurement	-20°C~1000°C -4°F~1832°F	-20~750°C		-20°C~1000°C -4°F~1832°F			
Resistance	60MΩ	40MΩ	20MΩ	60MΩ	60MΩ	20MΩ	2kΩ
Capacitance	60mF	100μF		60mF	100mF		
Diode	•	•	•	•	•	•	•
Continuity	•	•	•	•	•	•	•
Frequency	1KHz	100kHz		10MHz	10MHz		
Duty Cycle	•			•	•		
Small Current Measurement	•						
Inrush Current							
Insulation Test							
Low Impadance	•						
Low Pass Filter (ACV)							
Bar Graph							
V.F.C	•						
Relative Measurement							
MAX/MIN/AVG			MAX		MAX/MIN		
Data Hold	•	•	•	•	•	•	•
Flashlight			•	•	•		
Display Backlight	•	•	•	•	•	•	
Auto Power Off	•	•	•	•	•	•	
Power Supply	1.5V AAA*2	1.5V AAA*3	1.5V AAA*3	1.5V AAA*3	9V 6F22*1	1.5V AAA*3	1.5V AAA*3

DIGITAL CLAMP METERS AC CURRENT







DIGITAL CLAMP METERS AC/DC CURRENT

CAT II
CAT III
CAT IV





Model	MS2033A	MS2109B	MS2109C	MS2101	MS2103A	MS2103B
Page	104	105	106	107	108	109
Safety Rating	CAT III 600V	CAT III 600V	CAT III 600V	CAT III 600V CAT II 1000V	CAT III 600V	CAT III 600V
Display Counts	6000	2000	4000	4000	6000	4000
Jaw Size	Φ26mm 1.0"	23mm	23mm	Φ42mm 1.7"	19mm	19mm
Auto Ranging	•	•	•	•	•	•
True RMS			•		•	•
NCV		•	•		•	•
DC Voltage	600V	600V	600V	1000V	600V	600V
AC Voltage	600V	600V	600V	750V	600V	600V
DC Current				1000A	200A	200A
AC Current	600A	600A	600A	1000A	200A	200A
Temperature Measurement			-20°C~1000°C -0°F~1800°F	-40~750°C		-20°C~1000°C -4°F~1832°F
Resistance	10MΩ	20MΩ	40MΩ	40MΩ	60MΩ	40MΩ
Capacitance			10mF	100μF	60mF	4mF
Diode		•	•	•	•	•
Continuity	•	•	•	•	•	•
Frequency	3kHz		10MHz	100kHz	1MHz	10MHz
Duty Cycle	•		•	•	•	
Small Current Measurement					•	
Inrush Current						
Insulation Test						
Low Impadance						
Low Pass Filter (ACV)		•				
Bar Graph						
V.F.C						
Relative Measurement			•	•	•	•
MAX/MIN/AVG	MAX/MIN				MAX/MIN	•
Data Hold	•	•	•	•	•	•
Flashlight	•	•	•			•
Display Backlight	•	•	•		•	•
Auto Power Off	•	•	•	•	•	•
Power Supply	1.5V AAA*3	1.5V AAA*3	1.5V AAA*3	9V 6F22*1	1.5V AAA*2	1.5V AAA*2

DIGITAL CLAMP METERS
AC/DC CURRENT



							
Model	MS2108	MS2109A	MS2109D	MS2115A	MS2128	MS2138	MS2138R
Page	110	111	112	113	114	115	116
Safety Rating	CAT III 600V	CAT III 600V	CAT III 600V	CAT IV 600V CAT III 1000V	CAT III 600V	CAT III 600V	CAT III 600V
Display Counts	6600	6000	6000	6000	6600	4000	4000
Jaw Size		Φ26mm 1.0"	23mm	Φ40mm 1.6"	Φ26mm 1.0"	Φ40mm 1.6"	Φ40mm 1.6"
Auto Ranging	•	•	•	•	•	•	•
True RMS	•		•	•	•		•
NCV		•	•	•			
DC Voltage	600V	600V	1000V	1000V	600V	600V	600V
AC Voltage	600V	600V	750V	750V	600V	600V	600V
DC Current	600A	600A	1000A	1000A	600A	1000A	1000A
AC Current	600A	600A	1000A	1000A	600A	1000A	1000A
Temperature Measurement		-20°C~1000°C -4°F~1832°F	-20°C~1000°C 0°F~1800°F				
Resistance	66MΩ	60MΩ	60MΩ	60MΩ	66MΩ	40MΩ	40MΩ
Capacitance	66mF	4000μF	10mF	100mF	66mF	4000μF	4000μF
Diode	•	•	•	•	•	•	•
Continuity	•	•	•	•	•	•	•
Frequency	10kHz	10MHz	10MHz	10MHz	10kHz	10MHz	10MHz
Duty Cycle	•	•	•	•	•	•	•
Small Current Measurement							
Inrush Current			•	•			
Insulation Test							
Low Impadance							
Low Pass Filter (ACV)							
Bar Graph				•		•	•
V.F.C							
Relative Measurement		•	•	•		•	•
MAX/MIN/AVG	MAX/MIN	MAX/MIN		MAX/MIN	MAX/MIN		
Data Hold	•	•	•	•	•	•	•
Flashlight	•	•	•		•	•	•
Display Backlight	•	•	•	•	•	•	•
Auto Power Off	•	•	•	•	•	•	•
Power Supply	1.5V AAA*3	1.5V AAA*3	1.5V AAA*3	9V 6F22*1	1.5V AAA*3	1.5V AAA*3	1.5V AAA*3

DIGITAL CLAMP METERS LEAKAGE



DIGITAL CLAMP METERS POWER

	 CAT II CAT III CAT IV		
Model	MS2006B	MS2205	MS2225A
Page	117	118	119
Safety Rating	CAT III 600V	CAT III 600V	CAT IV 600V CAT III 1000V
Display Counts	2000	6000	6000
Jaw Size	Φ31mm 1.2"	Φ50mm 2.0"	Φ40mm 1.6"
Auto Ranging		•	•
True RMS		•	•
NCV			•
DC Voltage			1000V
AC Voltage		600V	750V
DC Current			
AC Current	60A	1000A	1000A
Output			
Temperature Measurement			
Resistance			60MΩ
Capacitance			100mF
Diode			•
Continuity			•
Frequency		1000Hz	10MHz
Duty Cycle			•
Inrush Current			•
Active Power		600kW	750kW
Apparent Power		600kVA	750kVA
Reactive Power		600kVAr	750kVAr
Power Factor		0.3~1	0.3~1
Harmonic Measurement		45~65Hz	45~65Hz
Relative Measurement			•
MAX/MIN/AVG		MAX/MIN	MAX/MIN
Data Hold	•	•	•
Flashlight			•
Display Backlight		•	•
Auto Power Off	•	•	•
Power Supply	1.5V AAA*2	1.5V AAA*4	9V 6F22*1





DIGITAL CLAMP METERS SPECIAL APPLICATION

			
	CAT II CAT III CAT IV		
Model	M9912	MS2601	MS3302
Page	120	121	122
Safety Rating	CAT II 1000V	CAT III 600V	CAT II 600V
Display Counts	3200	6000	
Jaw Size	Φ55mm 2.2"	Φ12mm 0.5"	Φ28mm 1.1"
Auto Ranging	•	•	
True RMS			
NCV		•	
DC Voltage	750V	600V	
AC Voltage	750V	600V	
DC Current	1000A	1000μA (From Plug)	
AC Current	1000A	200A	400A
Output			1mV/A
Temperature Measurement		-20°C~400°C -4°F~752°F	
Resistance	30MΩ	60MΩ	
Capacitance		60mF	
Diode	•	•	
Continuity	•	•	
Frequency	30kHz	60MHz	
Duty Cycle		•	
Low Impedance		•	
Data Hold	•	•	
Flashlight	•	•	
Display Backlight	•	•	
Auto Power Off		•	
Power Supply	9V 6F22*1	9V 6F22*1	

LINE SPLITTERS

			
	CAT II CAT III CAT IV		
Model	MS922A	MS922D	MS922E
Page	124	125	126
Safety Rating	CAT II 600V	CAT II 600V	CAT II 600V
AC Voltage	125V	250V	250V
AC Current	15A	15A	15A
Frequency	50~60Hz	50~60Hz	50~60Hz
Feature	-Allows for easy AC Current measurements -Using a Clamp meter on 2 or 3 Wire Power Cords -Provides the Ability to Safely Measure Current without the need to cut or separate conductors -Separates the Hot/Live conductor from the Neutral and Ground -Voltage check sockets for easy power calculations		
Style	USA	EU	UK

ELECTRICAL TESTERS

				
	CAT II CAT III CAT IV			
Model	MS8900	MS8900A	MS8902B	MS8922A
Page	128	129	130	131
Safety Rating	CAT III 600V CAT II 1000V	CAT III 600V CAT II 1000V	CAT III 600V CAT II 1000V	CAT III 400V
Non Contact Voltage	100~240V	90~1000V	20~1000V	
Contact Voltage				400V
Frequency	50~60Hz	50~60Hz	50~500Hz	50~60Hz
Metal Detecting			<20mm	
RCD Test				
Work Light				
Sound & Light	•	•	•	
Auto Power Off			•	
Sensitivity adjustment			•	
Power Supply	1.5V AAA*2	1.5V AAA*2	12V A23S*1	

CIRCUIT TESTERS

				
CAT II CAT III CAT IV				
Model	MS5902RT	MS5905RT	MS6861A	MS6863A
Page	133	134	135	136
Safety Rating	CAT II 600V	CAT II 600V	CAT II 300V	CAT II 300V
AC Voltage	230V/120V(US)	230V	175~250V/50~60Hz	175~250V/50~60Hz
Leakage Test Current			AC 220V±20V	AC 220V±20V
Leakage Test Voltage			>30mA	>30mA
Working Temperature	0 ~ 50°C	0 ~ 50°C	0 ~ 40°C	0 ~ 40°C
Working Humidity	<80%	<80%	20% ~ 75%RH	20% ~ 75%RH
GFCI Test	TF Type	TF Type		
Work Light	•			
NCV		•		
Voice Instruction	•	•	•	•
LED Instruction	•	•	•	•
LCD Panel Diagram				•
Socket Specification	EU,UK,US	EU,UK	CHN	EU
Power Supply	9V 6F22*1	9V 6F22*1		

CIRCUIT ANALYZERS

			
CAT II CAT III CAT IV			
Model	MS5900	MS5908A	MS5908C
Page	138	139	140
Safety Rating	CAT III 600V	CAT III 300V	CAT III 300V
AC Voltage	400V	190V	375V
Frequency	400Hz	45~65Hz	45~65Hz
Motor & Phase Rotation Indicator	•		
Voltage Drop Current		12/15/20A	5/8/10A
Impedance measurement		>3.00Ω	>3.00Ω
GFCI Test		•	•
RCD Test		•	•
Data Hold		•	•
Backlight		•	•
Power Supply	9V 6F22*1	1.5V AAA*6	1.5V AAA*6

WIRE TRACKER TRANSMITTER

CAT II
CAT III
CAT IV



Model	MS6815B
Page	142
Wire Tracking	Digital wire tracking
Wire Alignment	•
Open And Short Circuit	LED indication
Circuit Voltage Test	LED indication
Telephone Line Status	LED indication
POE Switch Tracking	•
Adjustable Sensitivity	Adjustable within 0-5cm
Flashlight	Receiver with flashlight
Display Mode	LED indication
Output Signal Level	About 5Vp-p
Max Working Current	Emitters60mA / Receivers80mA
Transmitting Signal Distance	≤3km
Low Battery Indication	Prompt when less than 7.2V
Power Supply	9V 6F22*2

WIRE & CABLE TESTERS

CAT II
CAT III
CAT IV



Model	MS6810	MS6811	MS6812A	MS6813	MS6818
Page	143	144	145	146	147
Safety Rating					CAT III 300V
Auto Ranging					•
DC Voltage					12~400V
AC Voltage					12~400V
Frequency			300kHz	300kHz	125kHz
Low Battery Indicator		•			
Sensitivity Adjustable			•	•	•
Electric Wire			•	•	•
Coaxial Cable (BNC)	•			•	
Network Cable	•	•		•	
Telephone Wire			•	•	
Backlight					•
Worklight					•
Sound & light instructions			•	•	•
Power Supply	9V 6F22*1	6V 4LR44/4AG13*1	9V 6F22*2	9V 6F22*2	9V 6F22*1 1.5V AAA*6

LCR METERS



Model	MS5308	MS6013	MS8910	MS8911	MY6243
Page	149	150	151	152	153
Auto Ranging			•	•	
Auto Power Off			•	•	
Resistance	20~200MΩ		300Ω/30MΩ	60Ω/20MΩ	
Capacitance	0.01pF~20mF	200pF/20mF	3nF/30mF	600pF/6mF	2nF/200μF
Inductance	20mH~20kH			600μH/200H	2mH~2H
Diode			•		
Continuity Buzzer			•		
Auto Scanning			•	•	
Zero Adjustment		•			
LCR/DCR	•			•	
Data Hold	•		•	•	
Backlight	•				
Relative Measurement	•				
Interface	RS232				
Power Supply	1.5V AA*8	9V 6F22*1	3V CR2032*1	3V CR2450*1	9V 6F22*1

EARTH RESISTANCE

CAT II
CAT III
CAT IV



Model	MS2301	MS2308
Page	155	156
Safety Rating	CAT III 150v	
Resistance	0.01Ω~1200Ω	0.02Ω~300kΩ
Measurement Voltage		AC 20V/48V DC 20V
Sensing & Inducing Current Transformer		•
Back light		•
Interface		USB
Power Supply	9V Alkaline Battery*2	1.5V AA*6 7.2V Ni-MH Recharge Battery

INSULATION TESTERS

CAT II
CAT III
CAT IV



Model	MS5201	MS5202	MS5215
Page	158	159	160
Safety Rating	CAT II 1000V CAT III 600V	CAT II 1000V	CAT III 1000V CAT IV 600V
Insulation Resistance	0.01MΩ~2GΩ	0.01MΩ~100GΩ	0.01MΩ~5TΩ
Output Voltage	1kV DC	2.5kV DC	5kV DC
Leakage Current test			1nA~3mA
Measurement Voltage	DC 1000V AC 700V	AC 5000V	DC 1000V AC 750V
Short Current	1.8mA		3mA
Temperature Test			-10~70°C
Back Light			•
Interface			USB
Power Supply	1.5V AA*6	1.5V AA*8 9V 6F22*1	1.5V LR14*6

DIGITAL THERMOMETERS



Model	MS6500	MS6503	MS6512A	MS6512B	MS6512C	MS6512	MS6514
Page	162	163	164	165	166	167	168
Thermocouple Type	K	K.J	K.J	K.J	K.J	K.J.T.E	K.J.T.E. R.S.N
Temperature Range	-50~750°C -58~1382°F	-200~1372°C -328~2501°F		-200~1372°C -328~2501°F		-200~1372°C -328~2501°F	-200~1372°C -328~2501°F
Injection Method	Single	Dual	Single	Dual	Four	Dual	Dual
Channel						T1/T2/T1-T2	T1/T2/T1-T2
Update Rate	500mS						
Upper Limit Alarm		Default value: 1300°C		Default value: 1300°C			
Lower Limit Alarm		Default value: -200°C		Default value: -200°C			
ADJ Compensation		-9~9°C		-9~9°C			
Ambient Temp.		0~60°C	0~60°C	-	-		
Recoerding interval time setting				H:M/M:S			
Bracket num				1/4 inch nut			
Sampling Rate		1 time/s		1 time/s			
Auto Power Off		10min		10min			
K Type Temp. probe		Random configuration probe Measurement range: -20°C~200°C (Accuracy ±2.5%)		Random configuration probe Measurement range: -50~300°C (Accuracy ±1.5%)			
MAX/MIN/AVG/DIF		MAX/MIN	MAX/MIN	MAX/MIN	MAX/MIN	MAX/MIN/AVG/ DIF	MAX/MIN/AVG/ DIF
Date Logging							1000 groups
Backlight		•					
Date Hold	•	•	•	•	•	•	•
USB Connection					•		•
Power Supply	9V 6F22*1	3*1.5V AAA	3*1.5V AA	3*1.5V AA	3*1.5V AA	9V 6F22*1	9V 6F22*1

INFRARED THERMOMETERS



Model	MS6522B	MS6525A	MS6525B	MS6531B	MS6531C
Page	169	170	171	172	173
Color Display				•	•
IRT Temperature	-20~500°C -4~932°F	-32~1100°C -26~2012°F	-32~1400°C -26~2552°F	-40~800°C -40~1472°F	-40~800°C -40~1472°F
Type K Temperature					-40~1080°C -40~1976°F
Repeatability		±1% / ±1°C (2°F)	±1% / ±1°C (2°F)		
Display resolution		32°C~1000°C (0.1°C) / 1000 above 1°C	32°C~1000°C (0.1°C) / 1000 above 1°C		
Response time		<500ms (95% of reading)	<500ms (95% of reading)		
Spectral response		8µm~14µm	8µm~14µm		
Measuring object distance ratio		50:1	50:1		
Laser aiming		Wavelength 620~690nm, output less than 1mW, laser grade: class 2	Wavelength 620~690nm, output less than 1mW, laser grade: class 2		
°C/°F Conversion		•	•		
Overrange prompt		"HI" or "LO"	"HI" or "LO"		
Distance to Spot(D:S)	10:1			12:1	12:1
Emissivity	0.95	0.1 to 1.00 adjustable in steps of 0.01 (default 0.95)	0.1 to 1.00 adjustable in steps of 0.01 (default 0.95)	0.1~0.99	0.1~0.99
MAX/MIN/AVG/DIF	MAX/MIN/AVG			•	•
Data Logging					20 groups
Backlight	•	•	•	•	•
Data hold	•			•	•
Power Supply	2*1.5V AAA	9V 6F22*1	9V 6F22*1	9V 6F22*1	9V 6F22*1

THERMO-HYGROMETERS



Model	MS6509
Page	175
LCD display	•
Backlight	•
Auto Power Off	•
Max / Min	•
Data Hold	•
Temperature Range	0°C~60°C/ 32°F~140°F
Humidity	0%~100%RH
Measuring Display	4 digits, max 9999
Power Supply	3*1.5V AAA

MOISTURE METERS



Model	MS6900	MS6900A	MS6901
Page	176	177	178
Ranging	Wood , Brick, Plaster ...	Wood , Brick, Plaster ...	
Testing Depth	0~50mm	0~50mm	5mm
Object moisture	0~60%	0~60%	0~54.8%RH
Ambient TEMP	-10~50°C 14~122°F	-10~50°C 14~122°F	0~60°C
Sampling Rate	240mS	240mS	2 time/s
MAX/MIN	•	•	•
Unit Selection	WB, TD, °C, °F, %RH	WB, TD, °C, °F, %RH	°C, °F, %RH
Humidity			0%~100%RH
Test Probe			M3 metric tooth test Pin, external hexagon 5mm
Measuring Display			4 digits, max 1999
Sampling Rate			2 time/s
Auto Power Off			10min (can be canceled manually)
Auxiliary Verification		•	
Backlight	•	•	•
Data Hold	•	•	•
Power Supply	2*1.5V AAA	2*1.5V AAA	3*1.5V AAA

SOUND METERS



Model	MS6701	MS6702A	MS6703A	MS6703B	MS6708
Page	179	180	181	182	183
Microphone		1/2 inch	1/2 inch		
Range	30~130dB	35~135dB	30~70dB, 60~90dB, 80~110dB, 100~130dB		30~130dB
Accuracy		±2.0dB	±1.5dB (sound pressure reference 94dB@1kHz)		
Dynamic	50dB				50dB
Frequency Weighting	A/C	A	A/C	A/C/Z	A/C
Time Weighting		FAST: 125ms/SLOW: 1s		FAST: 0.125 Sec/SLOW: 1 Sec	
Sampling Rate			2time/s		
Frequency	31.5Hz~8kHz	31.5Hz~8KHz	31.5Hz~8KHz		30Hz~8kHz
Analog Bar			One scale represents 1dB		
Display	2000	4 digit	4 digit, max1999		2000
Ambient Temperature		0°C~60°C 32°F~140°F	0°C~60°C		
Overload		OVER "Hi", UNDER "LO"	OVER "Hi", UNDER "LO"		
Analog Signal Output			AC / DC signal is output by the headphone jack socket: AC=100Vrms, DC=10mV/db		
USB Connection	•			•	
Data Logger	16000		1999groups		
Synchronous Update			Refer to PC information for program update		
Auto Power Off	•		15min(can be canceled)		•
MAX/MIN	MAX	MAX/MIN	MAX/MIN	MAX/MIN	MAX
Data Hold		•	•	•	•
AC Adapter	•				
AC/DC Signal Output	•				
Date / Time	•				
Backlight	•	•	•	•	•
Power Supply	1.5V AAA*6	1.5V AAA*3	1.5V AA*3	1.5V AA*3	1.5V AAA*4

ANEMOMETERS



Model	MS6252A	MS6252B	MS6253A	MS6253B	MS6652C
Page	184	185	186	187	188
Measurement Method			Integral Type		
Air Velocity Range	0.8~40 m/s 2.88~144 km/h 2.62~131.2 ft/s 1.6~77.70 Knots 1.8~90.00 mile/h 157.5~7874 ft/m		0.06~45.0m/s 1.0~162.0Km/h 10~8858ft/m 1.0~147.6ft/s 1.0~100.6mile/h 0.1~84.48Knots		0.4~30.0m/s 1.4~108km/h 80~5900ft/m 0.9~67.0mph 0.8~58.0knots
Bft			0~12		0~12
Ambient Temperature	-10~60°C		0°C~45°C (32.0°F~113.0°F)		0°C~60°C (32°F~140°F)
Air Volume Measurement	CMM 0~999.9 CFM 0~999.9 CMS 0~99.99		CFM 0~9999ft3 / min CMM 0~9999m3 / min CMS 0~9999m3 / s		CMM 0~9999 CFM 0~9999
Relative Humidity	20~80%RH				
Display	9999		4 digits, max 9999		4 digits, max 9999
Sensor				Infrared Laser Tube Cutting Method	Magnetic induction wind speed sensor and negative temperature coefficient temperature sensor
Sampling Rate	0.4s/time		2time/s		0.5sec
Repeated test deviation	±2%				
Data logger			1000groups		
USB connection	•		•		
Synchronous update			Refer to PC information for program update		
Auto power off	•	•	15min(can be canceled)		15min(can be canceled)
MAX/MIN	MAX/MIN	MAX/MIN	MAX/MIN	MAX/MIN	MAX/MIN
Data Hold	•	•	•	•	•
Backlight	•	•			•
Power Supply	9V 6F22*1	9V 6F22*1	1.5V AA*3	1.5V AA*3	1.5V AAA*3

LIGHT METERS



Model	MS6610	MS6612	MS6612A	MS6613A	MS6613B
Page	189	190	191	192	193
Display Counts	2000	2000	4 digits, max 9999	4 digits, max 9999	
Measuring Range	0~50000Lux	0 ~ 200000Lux 0 ~ 20000FC	0 ~200000Lux 0 ~20000FC	0.1 ~ 200000Lux 0.1 ~ 20000Fc	
Measuring Level				999.9 / 99999 / 19999*10Lux 99.9 / 999.9 / 19999FC	
Temperature Measuring			0°C~60°C	0°C~60°C	
Light Sensor				Digital Light Probes and Filters	
Sampling Rate			500ms	8time/s	
Incident Angle				120°	
Repeated Test Deviation				±2%	
Spectral Range				400~700nm	
Peak		•			
Relative		•			
Auto Power Off		•	•	15min(can be canceled)	
MAX/MIN		MAX/MIN	•	•	•
Data Hold	•	•	•	•	•
Backlight			•	•	•
Bar Graph		•		•	•
USB Connection					•
Power Supply	9V 6F22*1	9V 6F22*1	1.5V AAA*3	1.5V AAA*3	1.5V AAA*3

GAS DETECTOR



Model	MS6310	MS6311A	MS6311B
Page	194	195	196
Range	%LEL: 0~20%, PPM: 0~9999PPM		
Resolution	%LEL: 0~20.0%(0.1), PPM: 0~999PPM(0.1), 1000~9999PPM(1)		
Accuracy	±10%F.S.(CH4)		
Display	Analog bar		Analog bar and value
Alarm at level	10%~40%		
Response Time	2 seconds		
Warm up time	2 Minutes		
Easy to Identify	•		
Pinpoint Gas Leaks	•		
Portable	•		
Sensitivity	50PPM (CH4)		
Sensor	Semiconductor sensor		
Alarm mode	Display, sound & light alarm		
Auto zero	Auto-zero during warm-up process(in clean air)		
Resume Original measurement	State after 7~10 min in clear air		
Gas Detected	Natural gas, Methane, Ethane, Propane	Acetone, acetylene, alcohol, ammonia, benzene, butane, ethanol, oxirane, gasoline, hexane, hydrogen, methane, naphtha, natural gas, paint thinner, propane, solvent and etc	
Ambient Temp.			0°C~60°C, ±2°C
Auto power off	15 mins(can be canceled manually)		
Hi / Mid / Low		•	
Power Supply	4*1.5V AA	3.7V/1000mAH LI-IO, USB micro interface (DC 5V/1A)	

ENVIRONMENT TESTER



Model	MS6300
Page	197
Auto Ranging	•
Auto Power Off	•
Temperature	-10~60°C/14~140°F
Humidity	20~80%RH
Sound level	30~130dB
luminance	50000Lux
Wind Speed	0.5~20m/s, 1.8~72km/h 100~4000FPM, 0.9~38.9Knots
AirFlow [CMM]	0~999900
AirFlow [CFM]	0~999900
A/C Weighting	•
MAX/MIN/AVG/DIF	•
Data Hold	•
Backlight	•
Power Supply	9V 6F22*1

STUD METAL DETECTOR



Model	MS6906
Page	199
Auto Power Off	7 Minute
Wooden Pillar	30mm
Metal Stud Detection Detph	30mm
Metal Pipe Detector Depth	50mm
AC Voltage Detection Detph	75mm (50~600VAC)
Data Hold	•
Backlight	•

TACHOMETERS



Model	MS6208A	MS6208B	MS6208C
Page	200	201	202
Contact	50~19999		
Measurement	50~19999RPM	50~99999RPM (Non-Contact)	2.5~99999RPM
Measuring Distance	X	50~250mm	50~500mm
Ambient Temp.			0~60°C, ±2°C
Sampling Rate			Approx. 0.8s(over 60rpm/min)
Display			6digits, max 999999
Auto Power Off	•	•	•
MAX/MIN	•	•	•
Data Hold	•	•	•
Backlight	•	•	•
Unit Selection	•		•
Data Logging	100 Groups	100 Groups	
Power Supply	4*1.5V AAA	4*1.5V AAA	3*1.5V AAA

LASER DISTANCE METERS



Model	MS6406B	MS6408B	MS6410B
Page	203	204	205
Range	60m	80m	100m
Accuracy	±2.0mm	±2.0mm	±2.0mm
Measurement Unit	m, ft, in	m, ft, in	m, ft, in
Area Unit	m ² , ft ² , in ²	m ² , ft ² , in ²	m ² , ft ² , in ²
Laser Type	620~690nm	620~690nm	620~690nm
Laser Class	Class II, <1mW	Class II, <1mW	Class II, <1mW
Single Measurement	0.25s	0.25s	0.25s
Measurement Per Battery Pack	Approx. 1000	Approx. 1000	Approx. 1000
Automatic Laser Shut Down	After 30s	After 30s	After 30s
Automatic Device Shut Down	After 180s	After 180s	After 180s
Area / Volume Measurement	•	•	•
Indirect Pythagorean Theorem Measureme	•	•	•
Addition / Subtraction	•	•	•
Continuous	•	•	•
Multi-line Display	•	•	•
MAX / MIN	•	•	•
Voice Broadcast	•	•	•
Electronic Level Display	•	•	•
Data Clearance	•	•	•
Error Codes	•	•	•
Battery Status	•	•	•
Data Storage	99 Groups	99 Groups	99 Groups
Power Supply	3*1.5V AAA	3*1.5V AAA	3*1.5V AAA

DIGITAL MULTIMETERS

MANUAL RANGE | AUTO RANGE | POCKET & PEN TYPE
BENCH TYPE | SPECIAL APPLICATION





DIGITAL MULTIMETER

MAS830B

SKU NO.: MAS830BCBGLO
 UPC CODE: 810053674864
 EAN CODE: 8435394782072

FEATURE

- Diode Open Voltage 3.0V.
- Data Hold.
- Low Battery Display.

SPECIFICATIONS

AC Voltage 600V	DC Voltage 600V	DC Current 10A
Resistance 2MΩ	Display Counts 2000	

MAIN APPLICATIONS

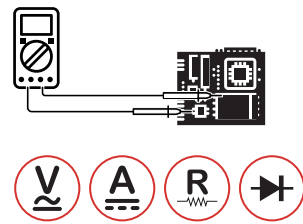
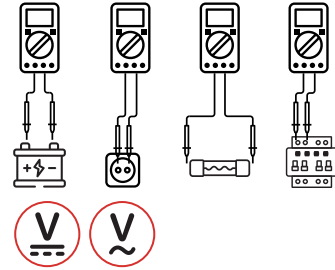

CONTENTS



145×76×40mm
 5.7"×3"×1.57"
 202g/0.44lb



1×9V 6F22
 Battery



Test Leads



Calibration
 Certificate

ACCESSORIES



Quick Start
 Guide

PACKAGING INFORMATION



Color Box
 L145×W60×H188mm



Carton Box
 40×32×31.5cm



X 20PCS



DIGITAL MULTIMETER

MAS838

SKU NO.: MAS838CBGLO
 UPC CODE: 810053672365
 EAN CODE: 8435394784304

FEATURE

- Diode Open Voltage 3.0V.
- Data Hold.
- Low Battery Display.
- Continuity Buzzer <math><70 \pm 30\Omega</math>.

SPECIFICATIONS

AC Voltage 600V	DC Voltage 600V	DC Current 10A
Resistance 2MΩ	Display Counts 2000	Continuity <math><70 \pm 30\Omega</math>
Temperature -20°C~1000°C		

MAIN APPLICATIONS

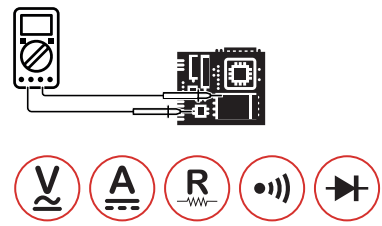
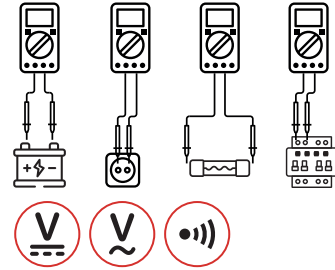

CONTENTS



145×76×40mm
 5.7"×3"×1.57"
 202g/0.44lb



1×9V 6F22
 Battery



Test Leads
 K-type thermocouple

ACCESSORIES



Calibration
 Certificate



Quick Start
 Guide

PACKAGING INFORMATION



Color Box
 L145×W60×H188mm



Carton Box
 40×32×31.5cm



X 20PCS

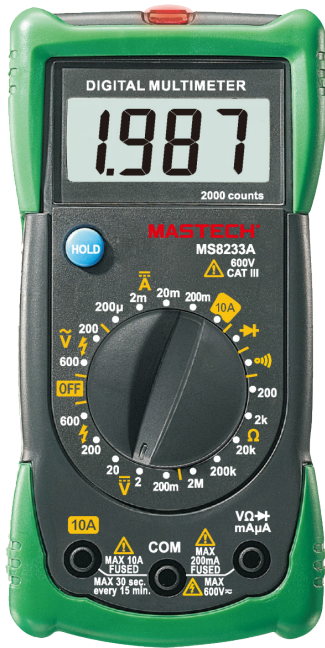

MAIN APPLICATIONS

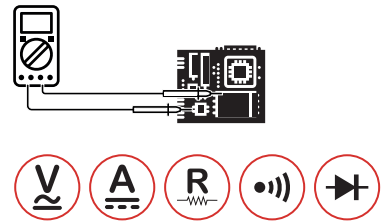
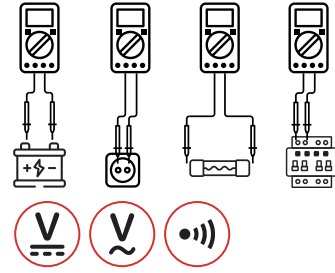

DIGITAL MULTIMETER
MS8233A

SKU NO.: MS8233ACBGLO
UPC CODE: 810053673140
EAN CODE: 8435394778877

FEATURE

- Diode Open Voltage 3.0V.
- Continuity Buzzer <60Ω.
- Data Hold.
- Low Battery Display.

SPECIFICATIONS

AC Voltage 600V	DC Voltage 600V	DC Current 10A
Resistance 2MΩ	Continuity <60Ω	Display Counts 2000

CONTENTS



140×67×30mm
5.5"×2.6"×1.2"
112g/0.25lb



1×9V 6F22
Battery



Test Leads
Battery



Calibration
Certificate

ACCESSORIES



Quick Start
Guide

PACKAGING INFORMATION



Color Box
L145×W60×H188mm



Carton Box
49×28×37cm



X 20PCS

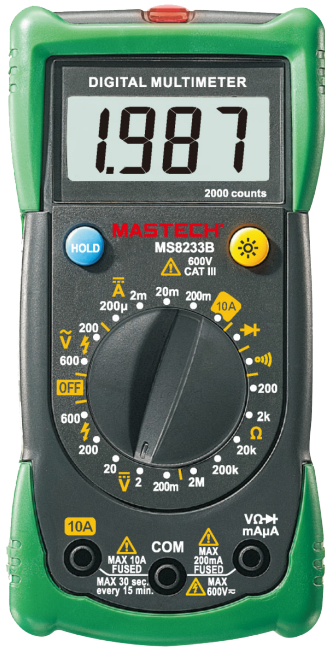

DIGITAL MULTIMETER MS8233B

SKU NO.: MS8233BCBGLO
UPC CODE: 810053674840
EAN CODE: 8435394783369

FEATURE

- Diode Open Voltage 3.0V.
- Low Battery Display.
- Display Backlight.
- Non-contact Voltage Detection.

SPECIFICATIONS

AC Voltage 600V	DC Voltage 600V	DC Current 10A
Resistance 2MΩ	Continuity <60Ω	Display Counts 2000

MAIN APPLICATIONS

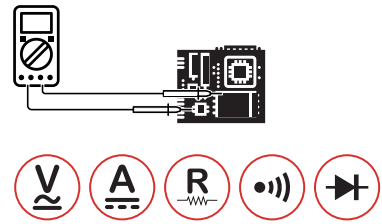
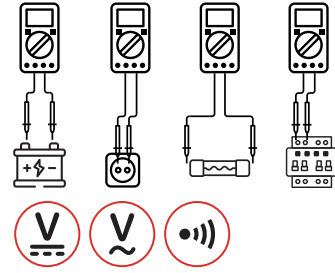

CONTENTS



140×67×30mm
5.5"×2.6"×1.2"
112g/0.25lb



1×9V 6F22
Battery



Test Leads
Battery



Calibration
Certificate

ACCESSORIES



Quick Start
Guide

PACKAGING INFORMATION



Color Box
L145×W60×H188mm



Carton Box
40×32×31.5cm



X 20PCS



DIGITAL MULTIMETER

MS8233C

SKU NO.: MS8233CCBGLO
 UPC CODE: 810053672228
 EAN CODE: 8435394777948

FEATURE

- Diode Open Voltage 3.0V.
- Low Battery Display.
- Display Backlight.
- Non-contact Voltage Detection.

SPECIFICATIONS

AC Voltage 600V	DC Voltage 600V	DC Current 10A
Resistance 2MΩ	Continuity <60Ω	Display Counts 2000
Temperature -20°C~1000°C/-4°F~1832°F		

MAIN APPLICATIONS

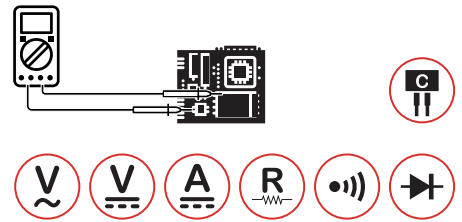
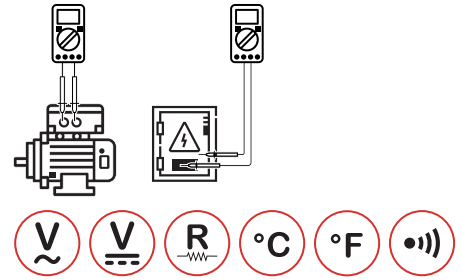
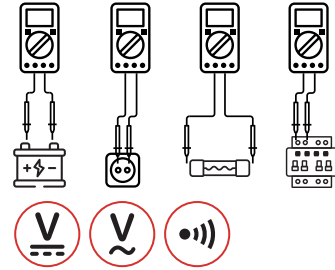

CONTENTS

- 140×67×30mm
5.5"×2.6"×1.2"
112g/0.25lb
- 1×9V 6F22 Battery
- Test Leads
- K-type thermocouple
- Battery
- Calibration Certificate
- Quick Start Guide

PACKAGING INFORMATION

- Color Box**
L145×W60×H188mm
- Carton Box**
40×32×31.5cm
- X 20PCS**



MAIN APPLICATIONS



DOMESTIC

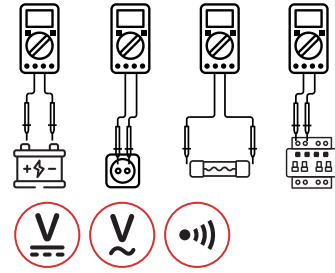

ELECTRONICS

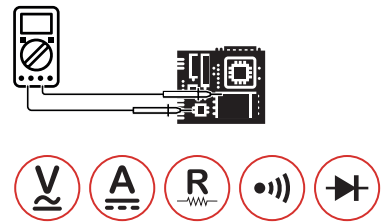

DIGITAL MULTIMETER
MS8238

SKU NO.: MS8238CBGLO
UPC CODE: 810053672662
EAN CODE: 8435394778303

FEATURE

- Diode Open Voltage 3.0V.
- Battery Test 1.5V/9V/12V.
- Data Hold.
- Low Battery Display.

SPECIFICATIONS

AC Voltage 600V	DC Voltage 600V	DC Current 10A
Resistance 2MΩ	Continuity <50Ω	Display Counts 2000

CONTENTS



148×73.5×50mm
5.8"×2.9"×1.96"
232g/0.51lb



1×9V 6F22
Battery



ACCESSORIES

Test Leads
Battery



Calibration
Certificate



Quick Start
Guide

PACKAGING INFORMATION



Color Box
L145×W60×H188mm



Carton Box
40×32×31.5cm



X 20PCS



DIGITAL MULTIMETER

MS8261

SKU NO.: MS8261CBGLO
 UPC CODE: 810053674437
 EAN CODE: 8435394779508

FEATURE

- Auto Power Off.
- Transistor hFE 0~1000.
- Diode Open Voltage 3.0V.
- Data Hold.

SPECIFICATIONS

AC Voltage 750V	DC Voltage 1000V	AC Current 10A
DC Current 10A	Resistance 200MΩ	Continuity <70Ω
Capacitance 20μF	Display Counts 2000	

MAIN APPLICATIONS

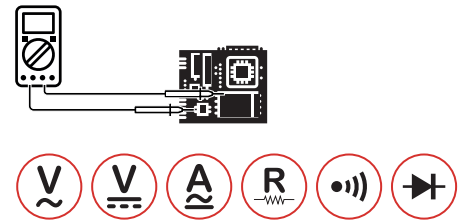
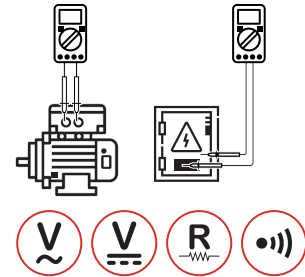
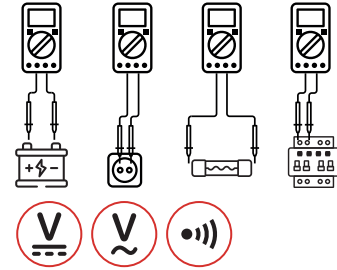

CONTENTS



195×92×55mm
 7.7"×3.6"×2.2"
 380g/0.83lb



1×9V 6F22
 Battery



ACCESSORIES

Test leads
 Multi-function socket
 Battery



Calibration
 Certificate



Quick Start
 Guide

PACKAGING INFORMATION



Color Box
 L165×W70×H225mm



Carton Box
 47×37.5×35.5cm



X 20PCS



DIGITAL MULTIMETER

MS8264

SKU NO.: MS8264CBGLO
 UPC CODE: 810053674444
 EAN CODE: 8435394779515

FEATURE

- Auto Power Off.
- Transistor hFE 0~1000.
- Diode Open Voltage 3.0V.
- Data Hold.

SPECIFICATIONS

AC Voltage 750V	DC Voltage 1000V	AC Current 10A
DC Current 10A	Resistance 200MΩ	Continuity <70Ω
Capacitance 20μF	Frequency 20kHz	Display Counts 2000
Temperature -20°C~1000°C		

MAIN APPLICATIONS

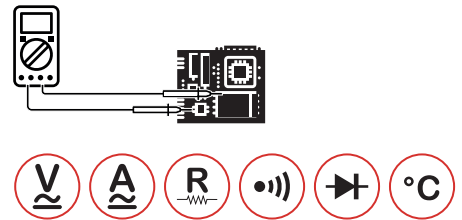
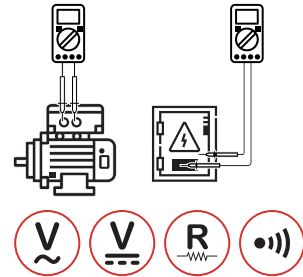
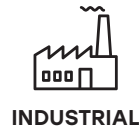
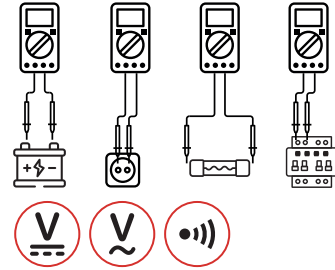

CONTENTS



195×92×55mm
 7.7"×3.6"×2.2"
 380g/0.83lb



1×9V 6F22
 Battery



ACCESSORIES

Test leads
 K type thermocouple
 Multi-function socket
 Battery



Calibration
 Certificate



Quick Start
 Guide

PACKAGING INFORMATION



Color Box
 L165×W70×H225mm



Carton Box
 47×37.5×35.5cm



X 20PCS



DIGITAL MULTIMETER MS8269

SKU NO.: MS8269CBGLO
UPC CODE: 810053674468
EAN CODE: 8435394779539

FEATURE

- Auto Power Off.
- Transistor hFE 0~1000.
- Diode Open Voltage 3.0V.
- Data Hold.

SPECIFICATIONS

AC Voltage 750V	DC Voltage 1000V	AC Current 10A
DC Current 10A	Resistance 20MΩ	Continuity test <70Ω
Capacitance 200μF	Inductance 20H	Display Counts 2000
Temperature -20°C~1000°C		

MAIN APPLICATIONS

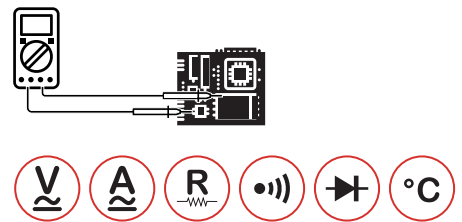
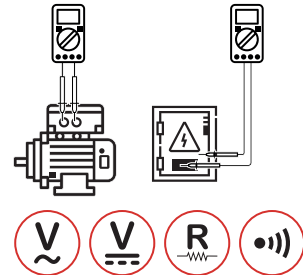
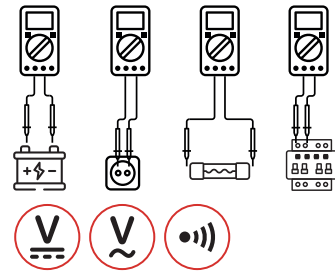

CONTENTS



195×92×55mm
7.7"×3.6"×2.2"
380g/0.83lb



1×9V 6F22
Battery



ACCESSORIES

Test leads
K type thermocouple
Multi-function socket
Battery



Calibration
Certificate



Quick Start
Guide

PACKAGING INFORMATION



Color Box
L165×W70×H225mm



Carton Box
47×37.5×35.5cm



X 20PCS



DIGITAL MULTIMETER
MS830M

SKU NO.: MS830MCBGLO
EAN CODE: 8435394788272

FEATURE

- Diode Test
- Continuity Check
- Unit Display

SPECIFICATIONS

AC Voltage 600V	DC Voltage 600V	DC Current 10A
Resistance 200MΩ	Display Counts 2000	

MAIN APPLICATIONS

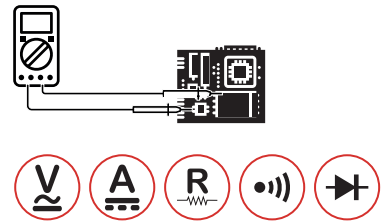
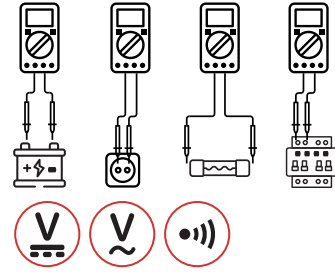

CONTENTS



133x71x47mm
5.2"x2.8"x1.8"
190g/0.42lb



1.5V AAA*2



Test Leads
Battery



Calibration
Certificate

ACCESSORIES



Quick Start
Guide

PACKAGING INFORMATION



Color Box
L112xW54xH155mm



Carton Box
57x33.5x25cm



X 40PCS



DIGITAL MULTIMETER
MS830N

SKU NO.: MS830NCBGLO
EAN CODE: 8435394788296

FEATURE

- Diode Test
- Continuity Check
- Unit Display

SPECIFICATIONS

AC Voltage 600V	DC Voltage 600V	DC Current 10A
Resistance 20MΩ	Display Counts 2000	

MAIN APPLICATIONS

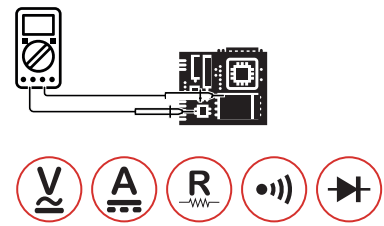
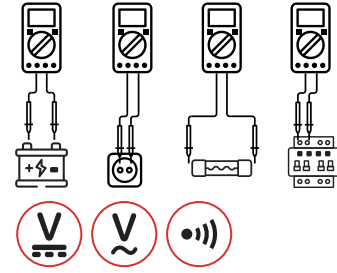

CONTENTS



133x71x47mm
5.2"x2.8"x1.8"
190g/0.42lb



1.5V AAA*2



Test Leads
Battery



Calibration
Certificate

ACCESSORIES



Quick Start
Guide

PACKAGING INFORMATION



Color Box
L112xW54xH155mm



Carton Box
57x33.5x25cm



X 40PCS



DIGITAL MULTIMETER - TRUE RMS
MS830T

SKU NO.: MS830TCBGLO
EAN CODE: 8435394788289

FEATURE

- Diode Test
- Continuity Check
- Unit Display

SPECIFICATIONS

AC Voltage 600V	DC Voltage 600V	DC Current 10A
AC Current 10A	Resistance 200MΩ	Display Counts 2000
Capacitance 200uF	Temperature -20°C~1000°C	Frequency 2KHz

MAIN APPLICATIONS

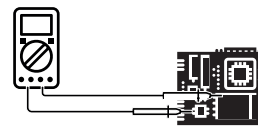
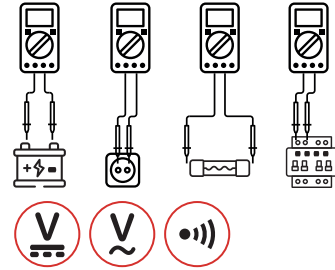

CONTENTS



133x71x47mm
5.2"x2.8"x1.8"
190g/0.42lb



1.5V AAA*2



ACCESSORIES

Test Leads
Temperature probe
Battery



Calibration
Certificate



Quick Start
Guide

PACKAGING INFORMATION



Color Box
L112xW54xH155mm



Carton Box
57x33.5x25cm



X 40PCS



DIGITAL MULTIMETER - TRUE RMS
MS850A

SKU NO.: MS850ACBGLO
EAN CODE: 8435394788302

FEATURE

- Buzzer / Continuity / Diode
- True RMS
- Non-Contact Voltage (NCV) Detection
- Live Wire(Live) Recognition

SPECIFICATIONS

AC Voltage 600V	DC Voltage 600V	DC Current 10A
AC Current 10A	Resistance 200MΩ	Display Counts 2000

MAIN APPLICATIONS

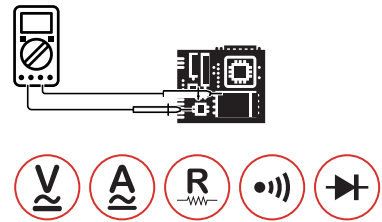
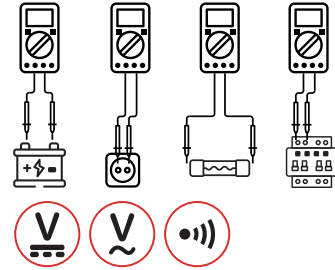

CONTENTS



150x75x47mm
5.9"x2.9"x1.8"
284g/0.63lb



1.5V AAA*2



Test Leads
Battery



Calibration
Certificate

ACCESSORIES



Quick Start
Guide

PACKAGING INFORMATION



Color Box
L112xW54xH155mm



Carton Box
57x33.5x25cm



X 40PCS



DIGITAL MULTIMETER - TRUE RMS
MS850B

SKU NO.: MS850BCBGLO
EAN CODE: 8435394788524

FEATURE

- Buzzer / Continuity / Diode
- MAX / MIN / True RMS / REL
- Non-Contact Voltage (NCV) Detection
- Live Wire(Live) Recognition

SPECIFICATIONS

AC Voltage 600V	DC Voltage 600V	AC Current 10A
DC Current 10A	Resistance 20MΩ	Display Counts 2000
Temperature -20°C~1000°C		

MAIN APPLICATIONS

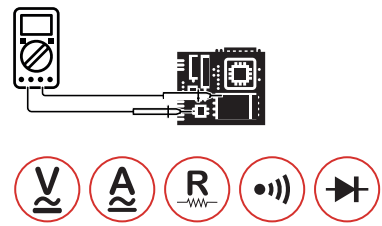
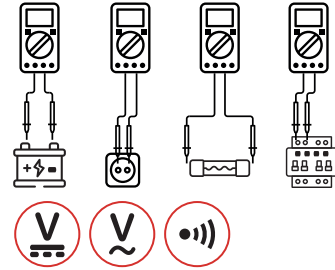

CONTENTS



150x75x47mm
5.9"x2.9"x1.8"
284g/0.63lb



1.5V AAA*2



ACCESSORIES

Test Leads
Temperature probe
Battery



Calibration
Certificate



Quick Start
Guide

PACKAGING INFORMATION



Color Box
L112xW54xH155mm



Carton Box
57x33.5x25cm



X 40PCS



DIGITAL MULTIMETER - TRUE RMS
MS890A

SKU NO.: MS890ACBGLO
EAN CODE: 8435394788333

FEATURE

- True RMS
- Overload Protection
- Transistor Test
- Diode / Continuity

SPECIFICATIONS

AC Voltage 750V	DC Voltage 1000V	DC Current 10A
AC Current 10A	Resistance 200MΩ	Capacitance 200uF
Frequency 200KHz	Display Counts 2000	Temperature -20°C~1000°C

MAIN APPLICATIONS

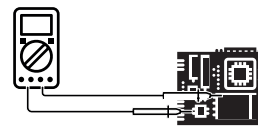
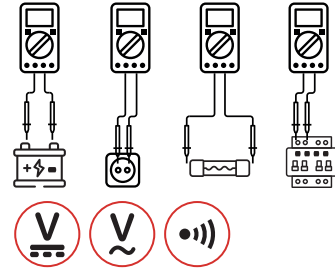

CONTENTS



185x88x54mm
7.3"x3.5"x2.1"
355g/0.78lb



9V 6F22 Battery



ACCESSORIES

Test leads
Temperature probe
Battery



Calibration Certificate



Quick Start Guide

PACKAGING INFORMATION



Color Box
L118xW58xH195mm



Carton Box
42x32.5x26cm



X 20PCS



DIGITAL MULTIMETER - TRUE RMS
MS890B

SKU NO.: MS890BCBGLO
EAN CODE: 8435394788340

FEATURE

- Overload Protection
- Transistor Test / Diode / Continuity / LED
- Non-Contact Voltage (NCV) Detection
- Live Wire(Live) Recognition

SPECIFICATIONS

AC Voltage 750V	DC Voltage 1000V	DC Current 20A
AC Current 20A	Resistance 40MΩ	Capacitance 40mF
Frequency 1KHz	Display Counts 4000	

MAIN APPLICATIONS

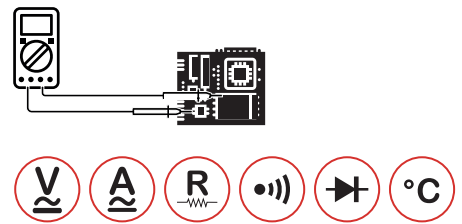
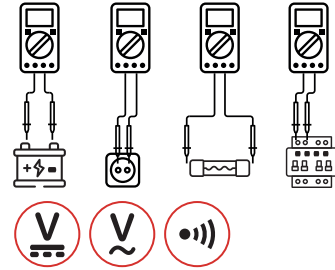

CONTENTS



185x88x54mm
7.3"x3.5"x2.1"
355g/0.78lb



1.5V AA*2



Test leads
Battery



Calibration
Certificate

ACCESSORIES



Quick Start
Guide

PACKAGING INFORMATION



Color Box
L118xW58xH195mm



Carton Box
42x32.5x26cm



X 20PCS



DIGITAL MULTIMETER - TRUE RMS
MS890C+

SKU NO.: MS890C+CBGLO
EAN CODE: 8435394788357

FEATURE

- Duty Cycle / Square Wave Output
- Overload Protection / Diode / Continuity
- Non-Contact Voltage (NCV) Detection
- Live Wire(Live) Recognition

SPECIFICATIONS

AC Voltage 750V	DC Voltage 1000V	DC Current 10A
AC Current 10A	Resistance 60MΩ	Capacitance 60mF
Frequency 10MHz	Display Counts 6000	Temperature -20°C~1000°C

MAIN APPLICATIONS



DOMESTIC

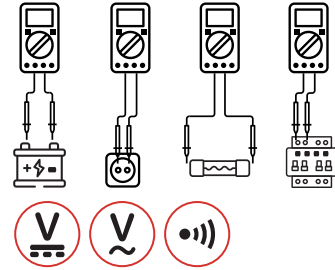

ELECTRONICS

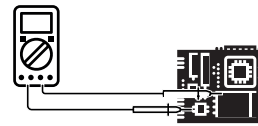

CONTENTS



185x88x54mm
7.3"x3.5"x2.1"
355g/0.78lb



1.5V AA*2



ACCESSORIES

Test Leads
Temperature probe
Battery



Calibration
Certificate



Quick Start
Guide

PACKAGING INFORMATION



Color Box
L118xW58xH195mm



Carton Box
42x32.5x26cm



X 20PCS



DIGITAL MULTIMETER - TRUE RMS
MS890D+

SKU NO.: MS890D+CBGLO
EAN CODE: 8435394788364

FEATURE

- True RMS
- Auto Power Off / Data Hold
- Non-Contact Voltage (NCV) Detection
- Live Wire(Live) Recognition

SPECIFICATIONS

AC Voltage 750V	DC Voltage 1000V	DC Current 20A
AC Current 20A	Resistance 40MΩ	Capacitance 40mF
Frequency 1KHz	Display Counts 4000	Temperature -20°C~1000°C

MAIN APPLICATIONS

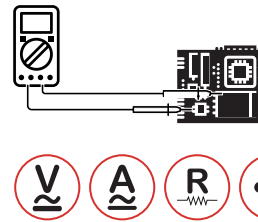
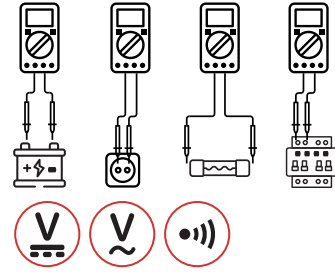

CONTENTS



185x88x54mm
7.3"x3.5"x2.1"
355g/0.78lb



1.5V AA*2



Test Leads
Temperature probe
Battery



Calibration
Certificate



Quick Start
Guide

PACKAGING INFORMATION



Color Box
L118xW58xH195mm



Carton Box
42x32.5x26cm



X 20PCS



DIGITAL MULTIMETER
MY60

SKU NO.: MY60CBGLO
UPC CODE: 810053672426
EAN CODE: 8435394778068

FEATURE

- Auto Power Off.
- Transistor hFE 0~1000.
- Diode Open Voltage 3.0V.
- Data Hold.

SPECIFICATIONS

AC Voltage 750V	DC Voltage 1000V	AC Current 10A
DC Current 10A	Resistance 200MΩ	Continuity <50Ω
Display Counts 2000		

MAIN APPLICATIONS

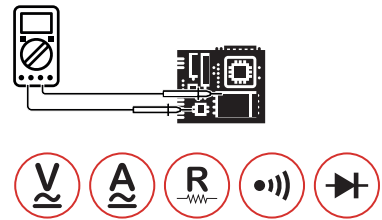
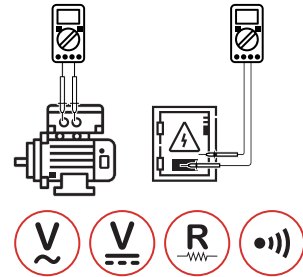
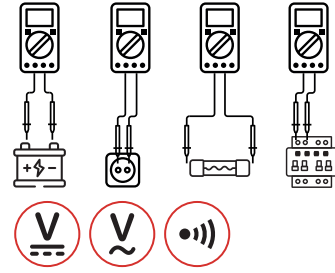

CONTENTS



195×95×55mm
7.67"×3.74"×2.16"
366g/0.8lb



1×9V 6F22
Battery



ACCESSORIES

Test leads
Multi-function socket
Battery



Calibration
Certificate



Quick Start
Guide

PACKAGING INFORMATION



Color Box
L165×W70×H225mm



Carton Box
47×37.5×35.5cm



X 20PCS



DIGITAL MULTIMETER
MY61

SKU NO.: MY61CBGLO
UPC CODE: 810053672419
EAN CODE: 8435394778051

FEATURE

- Auto Power Off.
- Transistor hFE 0~1000.
- Diode Open Voltage 3.0V.
- Data Hold.

SPECIFICATIONS

AC Voltage 750V	DC Voltage 1000V	AC Current 10A
DC Current 10A	Resistance 200MΩ	Capacitance 100μF
Continuity <50Ω	Display Counts 2000	

MAIN APPLICATIONS

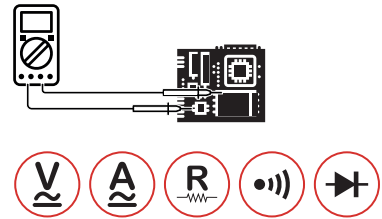
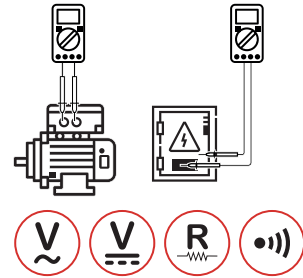
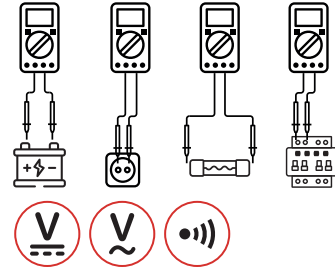

CONTENTS



195×95×55mm
7.67"×3.74"×2.16"
366g/0.8lb



1×9V 6F22
Battery



ACCESSORIES

Test leads
Multi-function socket
Battery



Calibration
Certificate



Quick Start
Guide

PACKAGING INFORMATION



Color Box
L165×W70×H225mm



Carton Box
47×37.5×35.5cm



X 20PCS



DIGITAL MULTIMETER
MY62

SKU NO.: MY62CBGLO
UPC CODE: 810053672433
EAN CODE: 8435394778075

FEATURE

- Auto Power Off.
- Transistor hFE 0~1000.
- Diode Open Voltage 3.0V.
- Data Hold.

SPECIFICATIONS

AC Voltage 750V	DC Voltage 1000V	AC Current 10A
DC Current 10A	Resistance 200MΩ	Capacitance 100μF
Temperature -20°C~1000°C	Continuity <50Ω	Display Counts 2000

MAIN APPLICATIONS

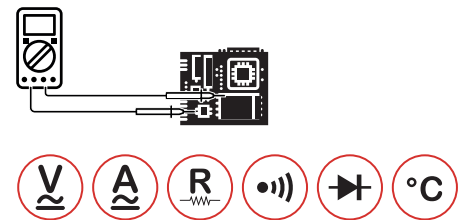
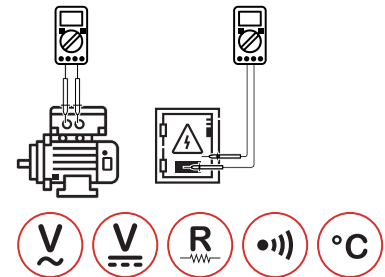
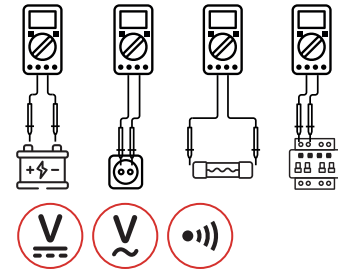

CONTENTS



195×95×55mm
7.67"×3.74"×2.16"
366g/0.8lb



1×9V 6F22
Battery



ACCESSORIES

Test leads
K type thermocouple
Multi-function socket
Battery



Calibration
Certificate



Quick Start
Guide

PACKAGING INFORMATION



Color Box
L165×W70×H225mm



Carton Box
47×37.5×35.5cm



X 20PCS



DIGITAL MULTIMETER **MY63**

SKU NO.: MY63CBGLO
UPC CODE: 810053674833
EAN CODE: 8435394782003

FEATURE

- Auto Power Off.
- Transistor hFE 0~1000.
- Diode Open Voltage 3.0V.
- Data Hold.

SPECIFICATIONS

AC Voltage 750V	DC Voltage 1000V	AC Current 10A
DC Current 10A	Resistance 200MΩ	Capacitance 100μF
Frequency 20kHz	Continuity <50Ω	Display Counts 2000

MAIN APPLICATIONS

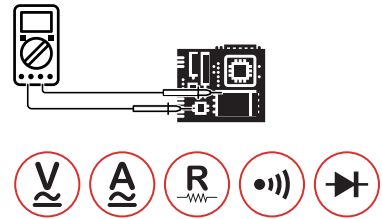
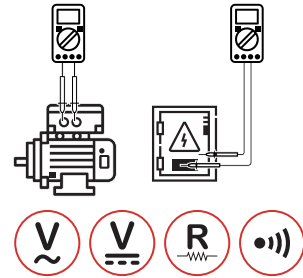
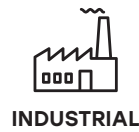
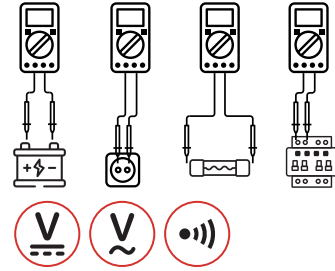

CONTENTS



195×95×55mm
7.67"×3.74"×2.16"
366g/0.8lb



1×9V 6F22
Battery



ACCESSORIES

Test leads
Multi-function socket
Battery



Calibration
Certificate



Quick Start
Guide

PACKAGING INFORMATION



Color Box
L165×W70×H225mm



Carton Box
47×37.5×35.5cm



X 20PCS



DIGITAL MULTIMETER
MY64

SKU NO.: MY64CBGLO
UPC CODE: 810053673324
EAN CODE: 8435394779058

FEATURE

- Auto Power Off.
- Transistor hFE 0~1000.
- Diode Open Voltage 3.0V.
- Data Hold.

SPECIFICATIONS

AC Voltage 750V	DC Voltage 1000V	AC Current 10A
DC Current 10A	Resistance 200MΩ	Capacitance 100μF
Frequency 20kHz	Continuity <50Ω	Display Counts 2000
Temperature -20°C~1000°C		

MAIN APPLICATIONS

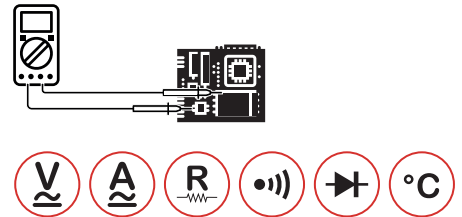
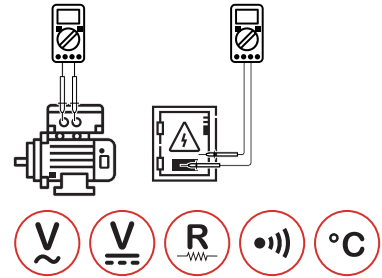
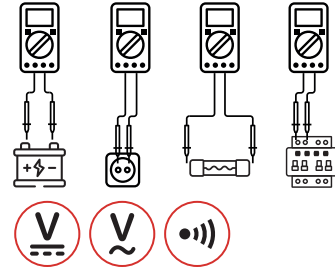

CONTENTS



195×95×55mm
7.67"×3.74"×2.16"
366g/0.8lb



1×9V 6F22
Battery



ACCESSORIES

Test leads
K type thermocouple
Multi-function socket
Battery



Calibration
Certificate



Quick Start
Guide

PACKAGING INFORMATION



Color Box
L165×W70×H225mm



Carton Box
47×37.5×35.5cm



X 20PCS



DIGITAL MULTIMETER MY65

SKU NO.: MY65CBGLO
 UPC CODE: 810053672440
 EAN CODE: 8435394778082

FEATURE

- Auto Power Off.
- Transistor hFE 0~1000.
- Diode Open Voltage 3.0V.
- Data Hold.

SPECIFICATIONS

AC Voltage 750V	DC Voltage 1000V	AC Current 10A
DC Current 10A	Resistance 200MΩ	Capacitance 100μF
Frequency 20kHz	Continuity <70Ω	Display Counts 20000

MAIN APPLICATIONS

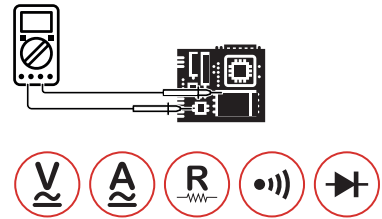
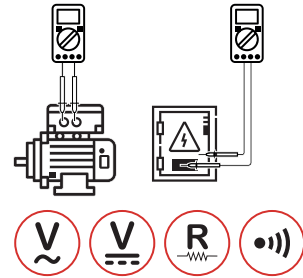
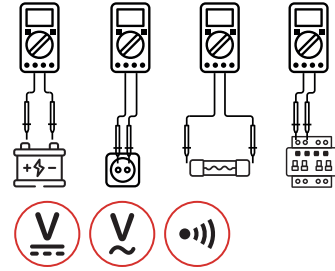

CONTENTS



195×95×55mm
 7.67"×3.74"×2.16"
 366g/0.8lb



1×9V 6F22
 Battery



ACCESSORIES

Test leads
 Multi-function socket
 Battery



Calibration
 Certificate



Quick Start
 Guide

PACKAGING INFORMATION



Color Box
 L165×W70×H225mm



Carton Box
 47×37.5×35.5cm



X 20PCS



DIGITAL MULTIMETER MS8217

SKU NO.: MS8217CBGLO
UPC CODE: 810053673263
EAN CODE: 8435394778990

FEATURE

- Auto & Manual Ranging.
- Auto Power Off.
- Relative Measurement.
- Diode Open Voltage 1.5V.

SPECIFICATIONS

AC Voltage 1000V	DC Voltage 1000V	AC Current 10A
DC Current 10A	Resistance 40MΩ	Capacitance 100uF
Frequency 100kHz	Continuity <50±20Ω	Display Counts 4000
Temperature -55°C~1000°C		

MAIN APPLICATIONS

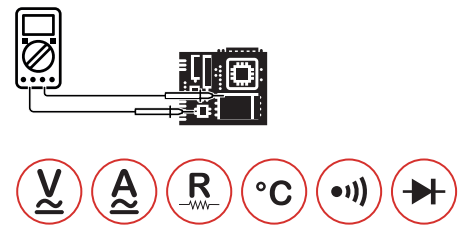
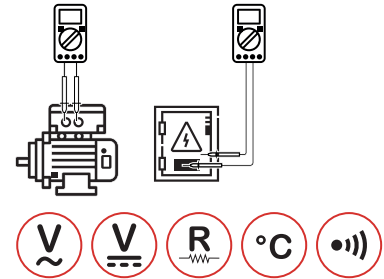
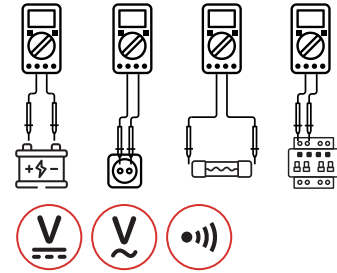

CONTENTS



185×87×53mm
7.28"×3.4"×2.04"
360g/0.79lb



3×1.5V AAA
Batteries



ACCESSORIES

Test leads
K type thermocouple
Multi-function socket
Battery



Calibration
Certificate



Quick Start
Guide

PACKAGING INFORMATION



Color Box
L165×W70×H225mm



Carton Box
47×37.5×35.5cm



X 20PCS



DIGITAL MULTIMETER

MS8221C

SKU NO.: MS8221CCBGLO
 UPC CODE: 810053672310
 EAN CODE: 8435394778457

FEATURE

- Auto & Manual Ranging.
- Auto Power Off.
- Diode Open Voltage 1.5V.

SPECIFICATIONS

AC Voltage 600V	DC Voltage 600V	AC Current 10A
DC Current 10A	Resistance 20MΩ	Capacitance 1000uF
Temperature -20°C~1000°C	Continuity <50±20Ω	Display Counts 2000

MAIN APPLICATIONS

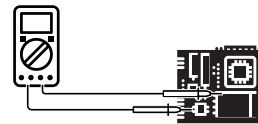
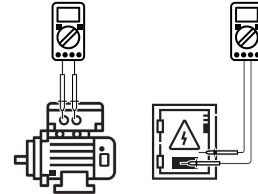
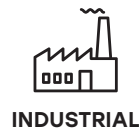
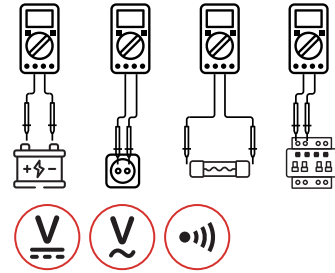

CONTENTS



158×74×32mm
 6.2"×2.9"×1.2"
 250g/0.55lb



3×1.5V AAA
 Battery



ACCESSORIES

Test leads
 K type thermocouple
 Multi-function socket
 Battery



Calibration
 Certificate



Quick Start
 Guide

PACKAGING INFORMATION



Color Box
 L145×W60×H188mm



Carton Box
 40×32×31.5cm



X 20PCS



DIGITAL MULTIMETER
MS8233E

SKU NO.: MS8233ECBGLO
UPC CODE: 810053672259
EAN CODE: 8435394777979

FEATURE

- Non-contact Voltage Detection.
- Maximum Measurement.
- Display Backlight.
- Low Battery Display.

SPECIFICATIONS

AC Voltage 600V	DC Voltage 600V	AC Current 10A
DC Current 10A	Resistance 20MΩ	Continuity <60Ω
Display Counts 2000	Temperature -20°C~1000°C/-4°F~1832°F	

MAIN APPLICATIONS

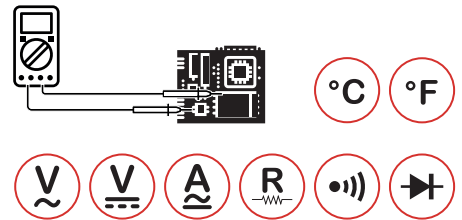
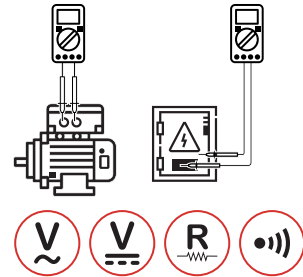
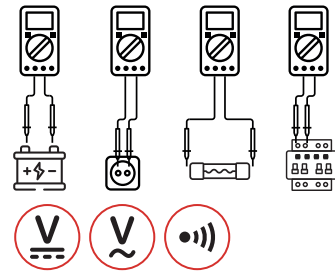

CONTENTS



140×67×30mm
5.5"×2.6"×1.2"
112g/0.25lb



1×9V 6F22
Battery



ACCESSORIES

Test leads
K type thermocouple
Battery



Calibration
Certificate



Quick Start
Guide

PACKAGING INFORMATION



Color Box
L145×W60×H188mm



Carton Box
40×32×31.5cm



X 20PCS



DIGITAL MULTIMETER
MS8239C

SKU NO.: MS8239CCBGLO
UPC CODE: 810053672266
EAN CODE: 8435394777986

FEATURE

- Auto & Manual Ranging.
- Auto Power Off.
- Diode Open Voltage 1.5V.
- Data Hold.

SPECIFICATIONS

AC Voltage 600V	DC Voltage 600V	AC Current 10A
DC Current 10A	Resistance 40MΩ	Continuity <50±20Ω
Frequency 10MHz	Temperature -20°C~1000°C/-4°F~1832°F	
Display Counts 4000		

MAIN APPLICATIONS

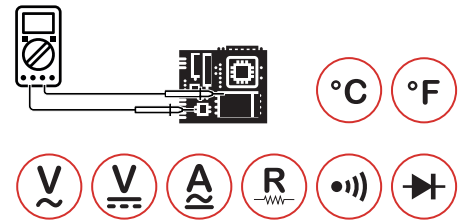
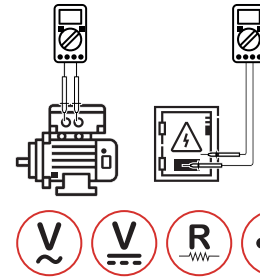
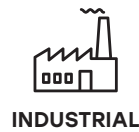
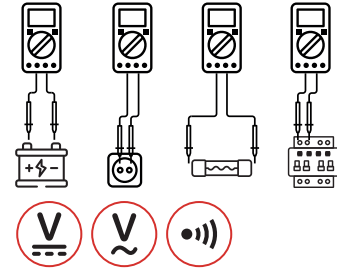

CONTENTS



150×74×41mm
5.9"×2.9"×1.6"
202g/0.44lb



2×1.5V AAA
Batteries



ACCESSORIES

Test leads
K type thermocouple
Battery



Calibration
Certificate



Quick Start
Guide

PACKAGING INFORMATION



Color Box
L145×W60×H188mm



Carton Box
40×32×31.5cm



X 20PCS



DIGITAL MULTIMETER - TRUE RMS
MS8239D+

SKU NO.: MS8239D+CBGLO
EAN CODE: 8435394788319

FEATURE

- Overload Protection
- True RMS
- Non-Contact Voltage (NCV) Detection

SPECIFICATIONS

AC Voltage 600V	DC Voltage 600V	DC Current 10A
AC Current 10A	Resistance 40MΩ	Capacitance 40.00mF
Frequency 10MHz	Display Counts 4000	

MAIN APPLICATIONS

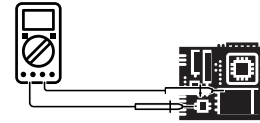
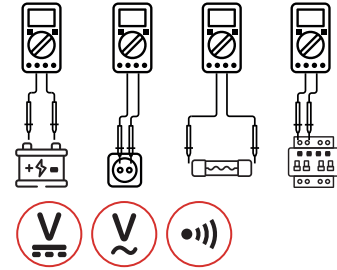

CONTENTS



147x74x46mm
5.8"x2.9"x1.8"
229g/0.50lb



1.5V AAA*2



Test Leads
Battery



Calibration
Certificate



Quick Start
Guide

PACKAGING INFORMATION



Color Box
L112xW54xH155mm



Carton Box
57x33.5x25cm



X 40PCS



DIGITAL MULTIMETER - TRUE RMS
MS8239T

SKU NO.: MS8239TCBGLO
EAN CODE: 8435394788326

FEATURE

- Overload Protection
- True RMS
- Non-Contact Voltage (NCV) Detection

SPECIFICATIONS

AC Voltage 600V	DC Voltage 600V	DC Current 10A
AC Current 10A	Resistance 40MΩ	Capacitance 40.00mF
Frequency 10MHz	Display Counts 4000	Temperature -20°C~750°C

MAIN APPLICATIONS

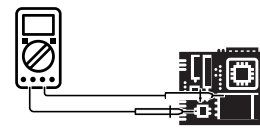
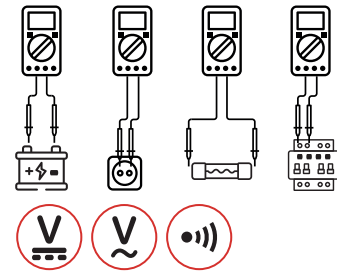

CONTENTS



147x74x46mm
5.8"x2.9"x1.8"
229g/0.50lb



1.5V AAA*2



ACCESSORIES

Test Leads
Temperature probe
Battery



Calibration
Certificate



Quick Start
Guide

PACKAGING INFORMATION



Color Box
L112xW54xH155mm



Carton Box
57x33.5x25cm



X 40PCS



DIGITAL MULTIMETER

MS8251A

SKU NO.: MS8251ACBGLO
 UPC CODE: 810053673157
 EAN CODE: 8435394778884

FEATURE

- Auto & Manual Ranging.
- Auto Power Off.
- Non-Contact Voltage Detector.

SPECIFICATIONS

AC Voltage 1000V	DC Voltage 1000V	AC Current 10A
DC Current 10A	Resistance 66MΩ	Continuity <50±20Ω
Capacitance 66mF	Frequency 66MHz	Display Counts 6600

MAIN APPLICATIONS

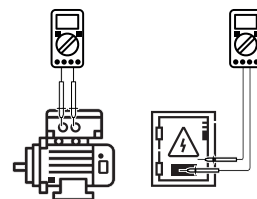
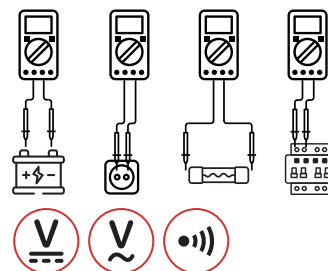

ELECTRONICS



CONTENTS



175×85×52mm
 6.89"×3.3"×2.1"
 420g/0.92lb



1×9V 6F22
 Battery



ACCESSORIES

Test leads
 K type thermocouple
 Multi-function socket
 Carrying strap
 Battery



Calibration
 Certificate



Quick Start
 Guide

PACKAGING INFORMATION



Color Box
 L165×W70×H225mm



Carton Box
 47×37.5×35.5cm



X 20PCS



DIGITAL MULTIMETER MS8251B

SKU NO.: MS8251BCBGLO
 UPC CODE: 810053672686
 EAN CODE: 8435394778327

FEATURE

- Auto & Manual Ranging.
- Auto Power Off.
- Relative Measurement.
- Non-Contact Voltage Detector.

SPECIFICATIONS

AC Voltage 1000V	DC Voltage 1000V	AC Current 10A
DC Current 10A	Resistance 66MΩ	Continuity <50±20Ω
Capacitance 66mF	Frequency 66MHz	Display Counts 6600
Temperature 0°C~1000°C/32°F~1832°F		

MAIN APPLICATIONS

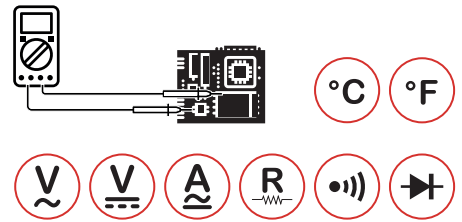
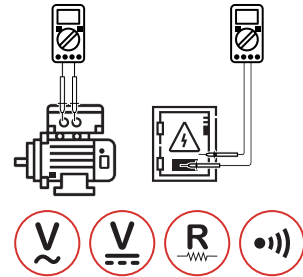
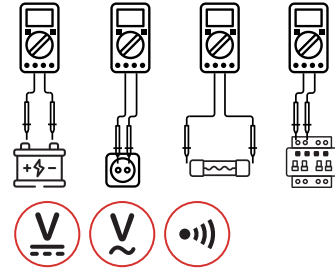

CONTENTS



175×85×52mm
 6.9"×3.3"×2.1"
 420g/0.92lb



1×9V 6F22
 Battery



Test leads
 K type thermocouple
 Multi-function socket
 Carrying strap
 Battery



Calibration
 Certificate



Quick Start
 Guide

PACKAGING INFORMATION



Color Box
 L165×W70×H225mm



Carton Box
 47×37.5×35.5cm



X 20PCS



DIGITAL MULTIMETER MS8268

SKU NO.: MS8268CBGLO
UPC CODE: 810053672709
EAN CODE: 8435394778341

FEATURE

- Auto Ranging.
- Auto Power Off.
- Sound & Light Warning.
- Relative Measurement.

SPECIFICATIONS

AC Voltage 750V	DC Voltage 1000V	AC Current 10A
DC Current 10A	Resistance 40MΩ	Continuity <70Ω
Capacitance 200μF	Frequency 200kHz	Display Counts 4000

MAIN APPLICATIONS

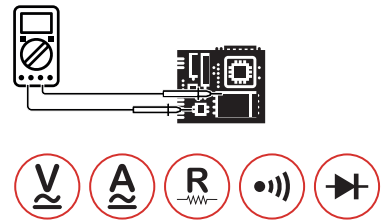
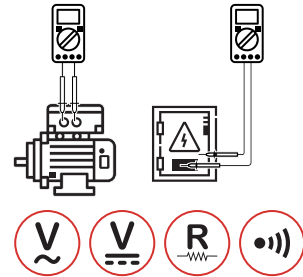
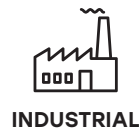
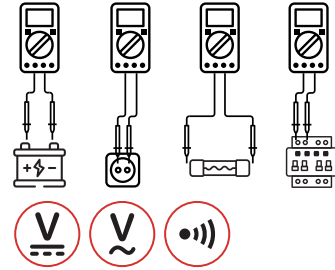

CONTENTS



195×92×55mm
7.7"×3.6"×2.2"
400g/0.9lb



3×1.5V AAA
Batteries



ACCESSORIES

Test leads
Multi-function socket
Battery



Calibration
Certificate



Quick Start
Guide

PACKAGING INFORMATION



Color Box
L165×W70×H225mm



Carton Box
47×37.5×35.5cm



X 20PCS



DIGITAL MULTIMETER MS8340A

SKU NO.: MS8340ACBGLO
 UPC CODE: 810053675359
 EAN CODE: 8435394783000

FEATURE

- Auto & Manual Ranging.
- Auto Power Off.
- Relative Measurement.
- Low Pass Filter 1kHz.

SPECIFICATIONS

AC Voltage 750V	DC Voltage 1000V	AC Current 10A
DC Current 10A	Resistance 60MΩ	Continuity <50±20Ω
Capacitance 400μF	Frequency 10MHz	Display Counts 6000
Temperature -10°C~700°C/-14°F~1292°F		

MAIN APPLICATIONS

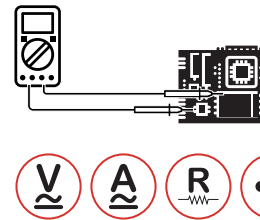
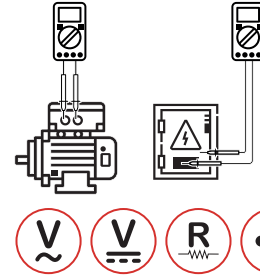
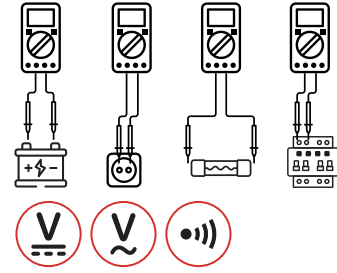

CONTENTS



205×102×58mm
 8.1"×4.0"×2.2"
 390g/0.86lb



4×1.5V AA
 Batteries



Test leads
 K type thermocouple
 Multi-function socket
 Battery



Calibration
 Certificate



Quick Start
 Guide

PACKAGING INFORMATION



Color Box
 L173×W85×H235mm



Carton Box
 49×45×37.2cm



X 20PCS



DIGITAL MULTIMETER - TRUE RMS
MS850C

SKU NO.: MS850CCBGLO
EAN CODE: 8435394788531

FEATURE

- Buzzer / Continuity / Diode
- MAX / MIN / True RMS / REL
- Non-Contact Voltage (NCV) Detection
- Live Wire(Live) Recognition

SPECIFICATIONS

AC Voltage 600V	DC Voltage 600V	DC Current 10A
AC Current 10A	Frequency 10MHz	Capacitance 100mF
Display Counts 4000		

MAIN APPLICATIONS

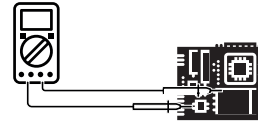
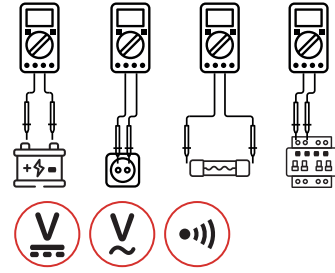

CONTENTS



150x75x47mm
5.9"x2.9"x1.8"
284g/0.63lb



1.5V AAA*2



ACCESSORIES

Test Leads
Temperature probe
Battery



Calibration
Certificate



Quick Start
Guide

PACKAGING INFORMATION



Color Box
L112xW54xH155mm



Carton Box
57x33.5x25cm



X 40PCS



DIGITAL MULTIMETER - TRUE RMS
MS850D

SKU NO.: MS850CCBGLO
EAN CODE: 8435394788531

FEATURE

- Buzzer / Continuity / Diode
- MAX / MIN / True RMS / REL
- Non-Contact Voltage (NCV) Detection
- Live Wire(Live) Recognition

SPECIFICATIONS

AC Voltage 600V	DC Voltage 600V	DC Current 10A
AC Current 10A	Frequency 10MHz	Capacitance 100mF
Display Counts 6000	Temperature -20°C~1000°C	

MAIN APPLICATIONS

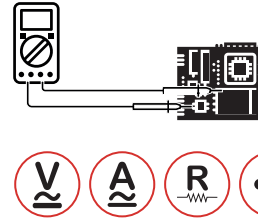
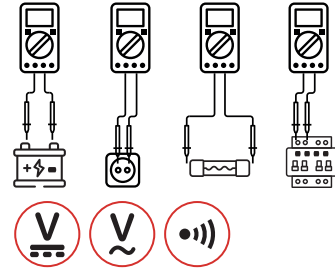

CONTENTS



150x75x47mm
5.9"x2.9"x1.8"
284g/0.63lb



1.5V AAA*2



ACCESSORIES

Test Leads
Temperature probe
Battery



Calibration Certificate



Quick Start Guide

PACKAGING INFORMATION



Color Box
L112xW54xH155mm



Carton Box
57x33.5x25cm



X 40PCS



DIGITAL MULTIMETER **MY68**

SKU NO.: MY68CBGLO
UPC CODE: 810053672457
EAN CODE: 8435394778099

FEATURE

- Auto Power Off.
- Transistor hFE 0~1000.
- Diode Open Voltage 3.0V.
- Data Hold.

SPECIFICATIONS

AC Voltage 750V	DC Voltage 1000V	AC Current 10A
DC Current 10A	Resistance 40MΩ	Capacitance 200μF
Frequency 200kHz	Continuity <50Ω	Display counts 4000

MAIN APPLICATIONS

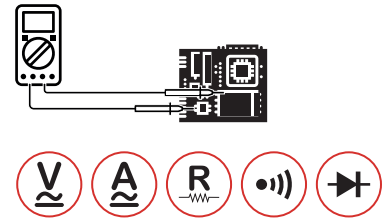
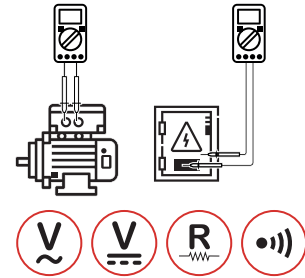
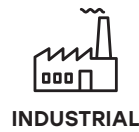
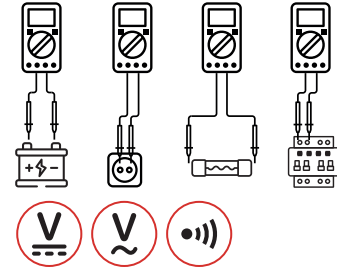

CONTENTS



189×91×31.5mm
7.67"×3.6"×1.24"
310g/0.5lb



1×9V 6F22
Battery



Test Leads
Battery

ACCESSORIES



Calibration
Certificate



Quick Start
Guide

PACKAGING INFORMATION



Color Box
L165×W70×H225mm



Carton Box
47×37.5×35.5cm



X 20PCS

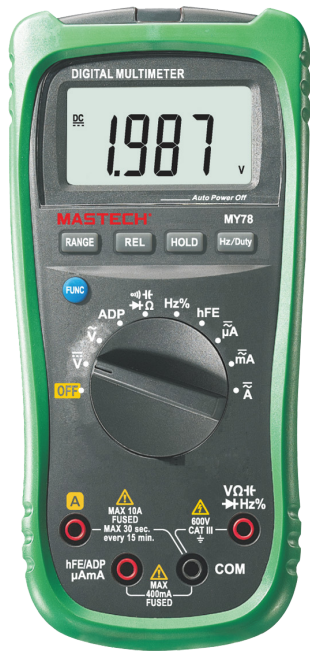

DIGITAL MULTIMETER
MY78

SKU NO.: MY78CBGLO
UPC CODE: 810053674550
EAN CODE: 8435394779621

FEATURE

- Auto & Manual Ranging.
- Relative Measurement.
- Diode Open Voltage 1.5V.
- Transistor hFE 0~1000.

SPECIFICATIONS

AC Voltage 600V	DC Voltage 600V	AC Current 10A
DC Current 10A	Resistance 40MΩ	Capacitance 200μF
Frequency 200kHz	Continuity <50±20Ω	Display Counts 4000

MAIN APPLICATIONS

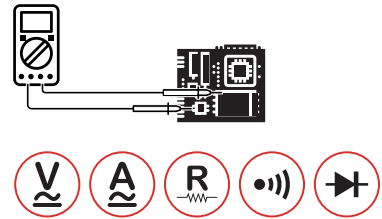
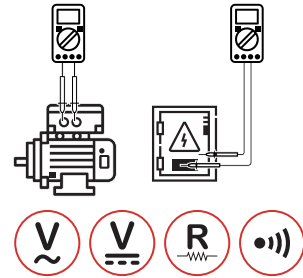
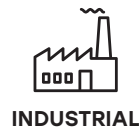
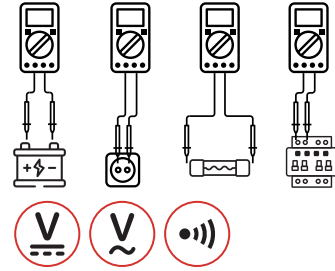

CONTENTS



189×91×31.5mm
7.67"×3.6"×1.24"
420g/0.92lb



1×9V 6F22
Battery



ACCESSORIES

Test leads
Multi-function socket
Battery



Calibration
Certificate



Quick Start
Guide

PACKAGING INFORMATION



Color Box
L165×W70×H225mm



Carton Box
47×37.5×35.5cm



X 20PCS



MAIN APPLICATIONS

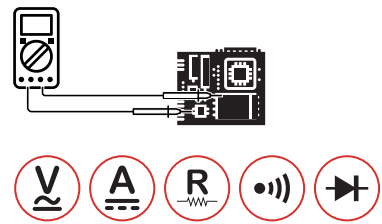
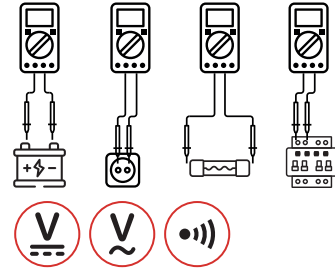

POCKET DIGITAL MULTIMETER
M320

SKU NO.: M320CBGLO
UPC CODE: 810053674048
EAN CODE: 8435394779119

FEATURE

- Auto Ranging.
- Auto Power Off.
- Diode Open Voltage 1.5V.
- Data Hold.

SPECIFICATIONS

AC Voltage 600V	DC Voltage 600V	AC Current 400mA
DC Current 400mA	Resistance 40MΩ	Frequency 100kHz
Display Counts 4000	Continuity <50±20Ω	

CONTENTS



120×70×18mm
4.7"×2.75"×0.7"
110g/0.23lb



2×1.5V 357A(LR44)
Batteries



ACCESSORIES

Test leads
Carry bag



Calibration
Certificate



Quick Start
Guide

PACKAGING INFORMATION



Color Box
L95xW35xH154mm



Carton Box
37x32.8x21.5cm



X 40PCS



POCKET DIGITAL MULTIMETER
M830B

SKU NO.: M830BCBGLO
UPC CODE: 810053672495
EAN CODE: 8435394778136

FEATURE

- Display 2000 Counts.
- Pocket Size.

SPECIFICATIONS

AC Voltage 600V	DC Voltage 600V	DC Current 10A
Resistance 2MΩ	Display Counts 2000	

MAIN APPLICATIONS

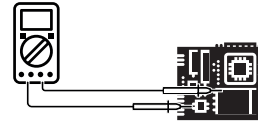
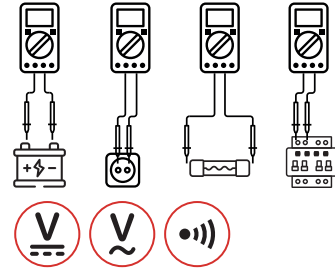

CONTENTS



126×70×25mm
4.9"×2.75"×0.9"
170g/0.4lb



1×9V 6F22
Battery



Test Leads



Calibration
Certificate

ACCESSORIES



Quick Start
Guide

PACKAGING INFORMATION



Color Box
L145×W60×H188mm



Carton Box
40×32×31.5cm



X 20PCS



POCKET DIGITAL MULTIMETER
M830BZ

SKU NO.: M830BZCBGLO
UPC CODE: 810053674581
EAN CODE: 8435394779652

FEATURE

- Display 2000 Counts.
- Pocket Size.

SPECIFICATIONS

AC Voltage 600V	DC Voltage 600V	DC Current 10A
Resistance 2MΩ	Display Counts 2000	

MAIN APPLICATIONS

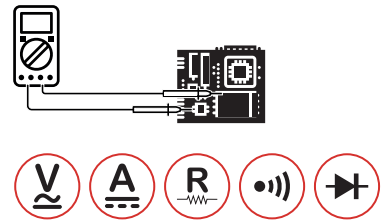
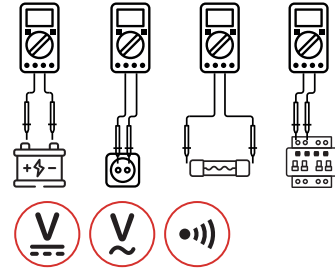

CONTENTS



126×70×25mm
4.9"×2.75"×0.9"
170g/0.4lb



1×9V 6F22
Battery



Test Leads



Calibration
Certificate

ACCESSORIES



Quick Start
Guide

PACKAGING INFORMATION



Color Box
L145×W60×H188mm



Carton Box
40×32×31.5cm



X 20PCS



POCKET DIGITAL MULTIMETER
M832

SKU NO.: M832CBGLO
UPC CODE: 810053672501
EAN CODE: 8435394778143

FEATURE

- Display 2000 Counts.
- Pocket Size.

SPECIFICATIONS

AC Voltage 600V	DC Voltage 600V	DC Current 10A
Resistance 2MΩ	Display Counts 2000	Continuity <50Ω

MAIN APPLICATIONS

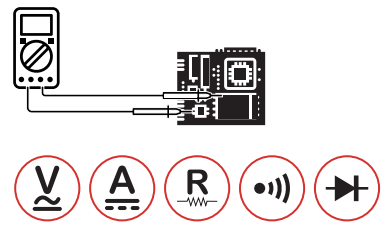
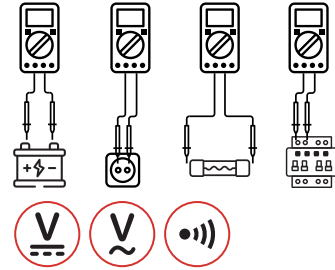

CONTENTS



126×70×25mm
4.9"×2.75"×0.9"
170g/0.4lb



1×9V 6F22
Battery



Test Leads



Calibration
Certificate

ACCESSORIES



Quick Start
Guide

PACKAGING INFORMATION



Color Box
L145×W60×H188mm



Carton Box
40×32×31.5cm



X 20PCS



POCKET DIGITAL MULTIMETER
M838

SKU NO.: M838CBAGLO
UPC CODE: 810053672518
EAN CODE: 8435394778150

FEATURE

- Display 2000 Counts.
- Pocket Size.

SPECIFICATIONS

AC Voltage 600V	DC Voltage 600V	DC Current 10A
Resistance 2MΩ	Display Counts 2000	Continuity <50Ω
Temperature -20~1370°C		

MAIN APPLICATIONS

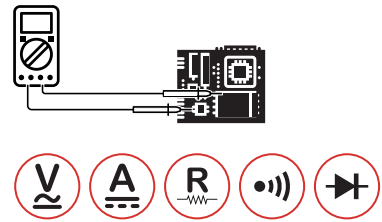
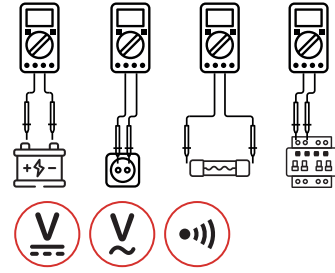

CONTENTS



126×70×25mm
4.9"×2.75"×0.9"
170g/0.4lb



1×9V 6F22
Battery



Test Leads
K-type thermocouple

ACCESSORIES



Calibration
Certificate



Quick Start
Guide

PACKAGING INFORMATION



Color Box
L145×W60×H188mm



Carton Box
40×32×31.5cm



X 20PCS



MAIN APPLICATIONS



DOMESTIC

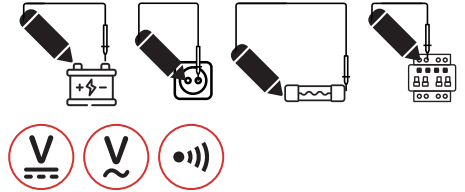

ELECTRONICS

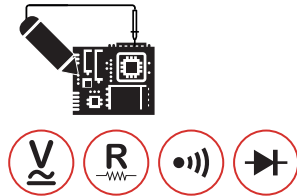

PEN-TYPE DIGITAL MULTIMETER
MS8211

SKU NO.: MS8211CBGLO
UPC CODE: 810053673010
EAN CODE: 8435394778976

FEATURE

- Auto & Manual Ranging.
- Auto Power Off.
- Diode Open Voltage 1.5V.
- Maximum Value Hold.

SPECIFICATIONS

AC Voltage 600V	DC Voltage 600V	Resistance 20MΩ
Continuity <50±20Ω	Display Counts 2000	

CONTENTS



208×38×29mm
8.26"×1.5"×1.1"
110g/0.24lb



2×1.5V AAA
Batteries



ACCESSORIES

Test leads
Alligator Clips
Carry bag
Battery



Calibration
Certificate



Quick Start
Guide

PACKAGING INFORMATION



Color Box
L85×W45×H220mm



Carton Box
46×26×36cm



X 40PCS



MAIN APPLICATIONS

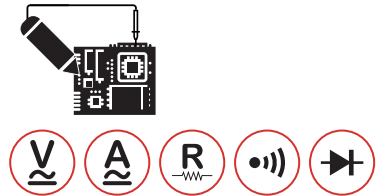
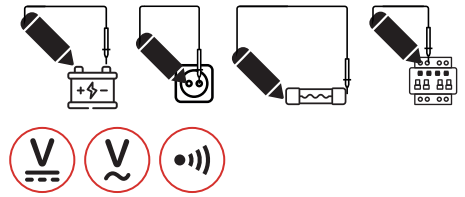

PEN-TYPE DIGITAL MULTIMETER
MS8211D

SKU NO.: MS8211DCBGLO
UPC CODE: 810053672655
EAN CODE: 8435394778747

FEATURE

- Auto & Manual Ranging.
- Auto Power Off.
- Diode Open Voltage 1.5V.
- Maximum Value Hold.

SPECIFICATIONS

AC Voltage 600V	DC Voltage 600V	AC Current 200mA
DC Current 200mA	Resistance 20MΩ	Continuity <50±20Ω
Display Counts 2000		

CONTENTS



208×38×29mm
8.26"×1.5"×1.1"
110g/0.24lb



2×1.5V AAA
Batteries



ACCESSORIES

Test leads
Alligator Clips
Carry bag
Battery



Calibration
Certificate



Quick Start
Guide

PACKAGING INFORMATION



Color Box
L85×W45×H220mm



Carton Box
46×26×36cm



X 40PCS



MAIN APPLICATIONS

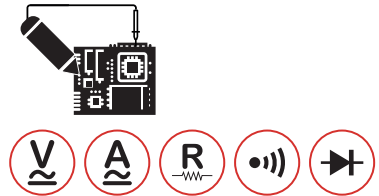
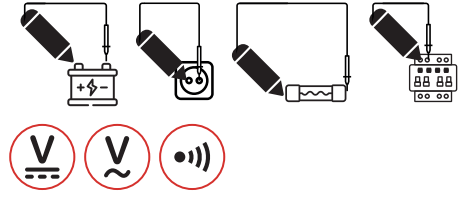

PEN-TYPE DIGITAL MULTIMETER
MS8212A

SKU NO.: MS8212ACBGLO
UPC CODE: 810053673034
EAN CODE: 8435394778761

FEATURE

- Auto & Manual Ranging.
- Auto Power Off.
- Diode Open Voltage 1.5V.
- Maximum Value Hold.

SPECIFICATIONS

AC Voltage 600V	DC Voltage 600V	AC Current 200mA
DC Current 200mA	Resistance 20MΩ	Continuity <50±20Ω
Display Counts 2000		

CONTENTS



238×43×29mm
9.37"×1.7"×1.1"
112g/0.28lb



2×1.5V AAA
Batteries



ACCESSORIES

Test leads
Alligator Clips
Carry bag
Battery



Calibration
Certificate



Quick Start
Guide

PACKAGING INFORMATION



Color Box
L85×W45×H236mm



Carton Box
49×28×37cm



X 40PCS



DIGITAL MULTIMETER
MS8223A

SKU NO.: MS8223ACBGLO
UPC CODE: 810053672211
EAN CODE: 8435394777931

FEATURE

- Auto & Manual Ranging.
- Auto Power Off.
- Diode Open Voltage 1.5V.
- Maximum Value Hold.

SPECIFICATIONS

AC Voltage 600V	DC Voltage 600V	AC Current 200mA
DC Current 200mA	Resistance 20MΩ	Continuity <50Ω
Display Counts 2000		

MAIN APPLICATIONS

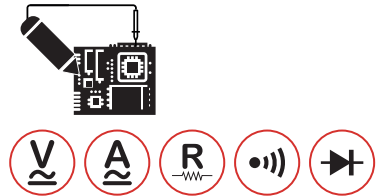
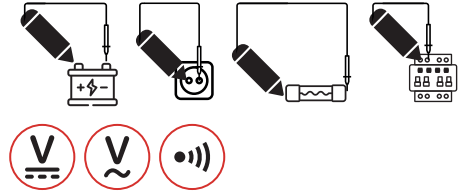

CONTENTS



225×52×40mm
8.86"×2.0"×1.58"
138g/0.3lb



2×1.5V AAA
Batteries



ACCESSORIES

Test leads
Alligator Clips
Carry bag
Battery



Calibration
Certificate



Quick Start
Guide

PACKAGING INFORMATION



Color Box
L85×W50×H236mm



Carton Box
49×28×37cm



X 40PCS



TRUE RMS BENCHTOP MULTIMETER
MS8040

SKU NO.: MS8040CBGLO
UPC CODE: 810053672631
EAN CODE: 8435394778273

FEATURE

- Auto & Manual Ranging.
- True RMS for AC Voltage & AC Current.
- Low Pass Filter (1kHz) for AC Voltage & AC Current.

SPECIFICATIONS

AC Voltage 750V	DC Voltage 1000V	AC Current 10A
DC Current 10A	Resistance 200MΩ	Capacitance 20mF
Display Counts 22000		

MAIN APPLICATIONS

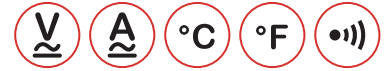
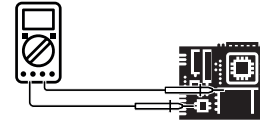

CONTENTS

- 238×230×83mm
9.4"×9.1×3.3"
1500g/3.4lb
- 220V/110V AC
(50~60Hz)
- Test Leads
K Type Thermocouple
Multi-function socket
RS232C Cable
Power cord
Software CD
Carrying strap
- Calibration Certificate
- Quick Start Guide

PACKAGING INFORMATION

Color Box
L300×W110×H280mm

Carton Box
58.5×32×29.5cm

X 5PCS



DIGITAL INSULATION MULTIMETER MS5208

SKU NO.: MS5208CBGLO
UPC CODE: 810053673065
EAN CODE: 8435394778792

FEATURE

- Auto & Manual Ranging.
- Auto Power Off.
- True RMS For AC Voltage & AC Current.
- DAR/PI Mod.

SPECIFICATIONS

AC Voltage 750V	DC Voltage 1000V	AC Current 400mA
DC Current 400mA	DC Output 1000V	Resistance 66MΩ
Capacitance 66mF	Frequency 10kHz	Continuity <30Ω
Display Counts 6600	Temperature -30°C~1300°C / -22°F~2372°F	

MAIN APPLICATIONS

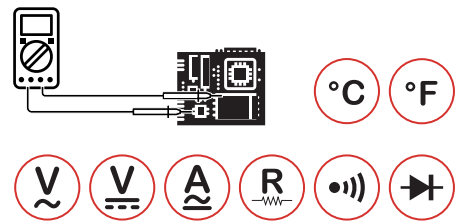
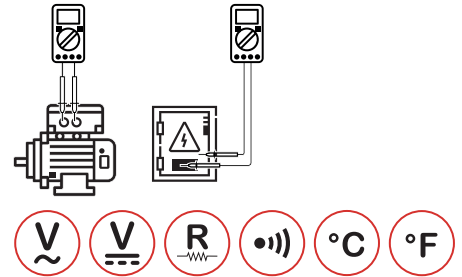
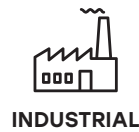
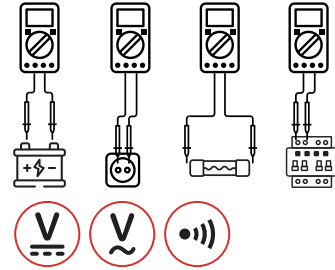

CONTENTS



205x102x58mm
8.1"x4.0"x2.3"
390g/0.86lb



4x1.5V AA
Batteries



ACCESSORIES

Test Leads
Test Clips
K Type Thermocouple
Multi-function socket
Carry Bag
Battery



Calibration
Certificate



Quick Start
Guide

PACKAGING INFORMATION



Color Box
L172xW80xH255mm



Carton Box
53x44.5x37cm



X 20PCS



DIGITAL MULTIMETER WITH ENVIRONMENT 5 IN 1

MS8229

SKU NO.: MS8229CBAGLO
 UPC CODE: 810053672327
 EAN CODE: 8435394778433

FEATURE

- Hinged Bracket Facilitate Table Work.
- Auto-Ranging, Relative, Humidity, Luminosity & Sound level.
- For Professional Use.

SPECIFICATIONS

AC Voltage 750V	DC Voltage 1000V	AC Current 10A
DC Current 10A	Resistance 40MΩ	Capacitance 100uF
Frequency >200kHz	Continuity <50±20Ω	Display Counts 4000
Temperature -20°C~1000°C/-4°F~1832°F		

MAIN APPLICATIONS

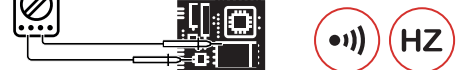
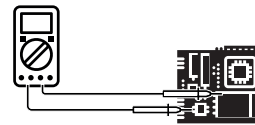
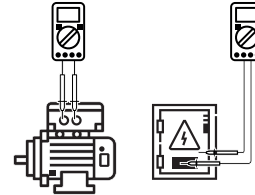
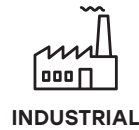
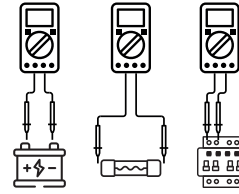

CONTENTS



195×92×55mm
 7.7"×3.6"×2.2"
 390g/0.86lb



3×1.5V AAA
 Batteries



ACCESSORIES

Test leads
 K type thermocouple
 Battery



Calibration
 Certificate



Quick Start
 Guide

PACKAGING INFORMATION



Color Box
 L165×W70×H225mm



Carton Box
 47×37.5×35.5cm



X 20PCS



**DIGITAL MULTIMETER WITH LAN/PHONE/
TONE TESTER**

MS8236

SKU NO.: MS8236CBGLO
UPC CODE: 810053673003
EAN CODE: 8435394778624

FEATURE

- Auto & Manual Ranging.
- Auto Power Off.
- Non-Contact Voltage Detector.
- Diode Open Voltage 1.7V.

SPECIFICATIONS

AC Voltage 600V	DC Voltage 600V	AC Current 10A
DC Current 10A	Resistance 20MΩ	Continuity <70Ω
Display counts 2000		

MAIN APPLICATIONS

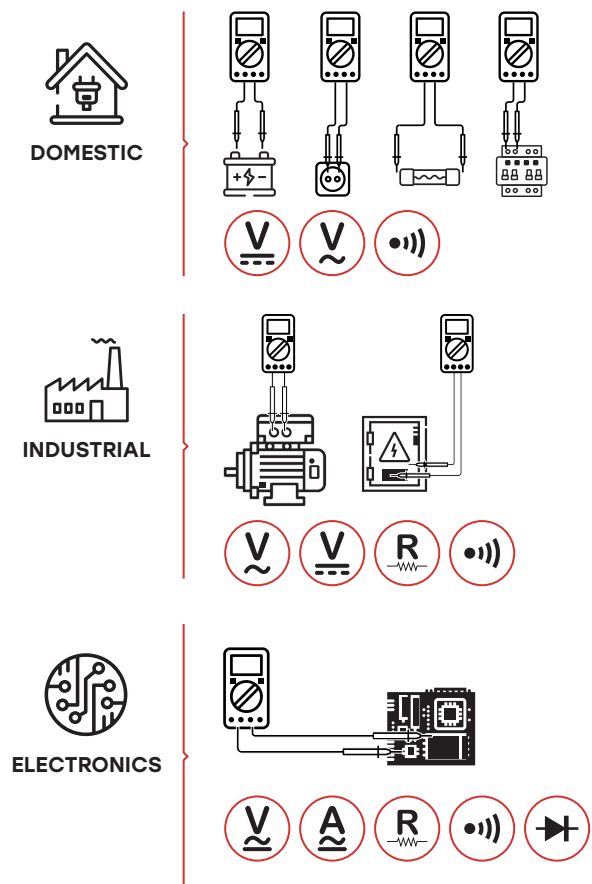

CONTENTS

	MS8236: 195×92×55mm 7.7"×3.6"×2.2" 470g/1.04lb		MS6812R: 238×43×26mm 9.4"×1.7"×1.0"
	Test leads Detection connect line Battery		2×9V 6F22 Batteries
	Calibration Certificate		Quick Start Guide

PACKAGING INFORMATION

	Color Box L188×W88×H264mm		Carton Box 55×48.5×39.5mm		X 40PCS
--	-------------------------------------	--	-------------------------------------	--	----------------



DIGITAL MULTIMETER (ENGINE ANALYZER)
MS8239D

SKU NO.: MS8239DCBGLO
UPC CODE: 810053672983
EAN CODE: 8435394778716

FEATURE

- Auto & Manual Ranging.
- Auto Power Off.
- Diode Open Voltage 2.7V.
- Maximum Measurement.

SPECIFICATIONS

AC Voltage 600V	DC Voltage 600V	AC Current 10A
DC Current 10A	Resistance 40MΩ	Continuity <50Ω
Display Counts 2000		

MAIN APPLICATIONS

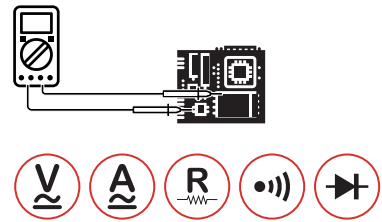
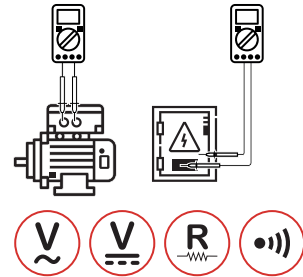
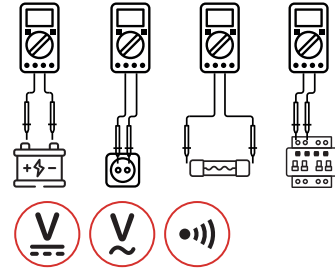

CONTENTS



150×74×41mm
5.9"×2.9"×1.6"
202g/0.44lb



2×1.5V AAA
Batteries



Test leads
Battery

ACCESSORIES



Calibration
Certificate



Quick Start
Guide

PACKAGING INFORMATION



Color Box
L145×W60×H188mm



Carton Box
40×32×31.5cm



X 20PCS



MAIN APPLICATIONS



DOMESTIC

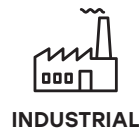
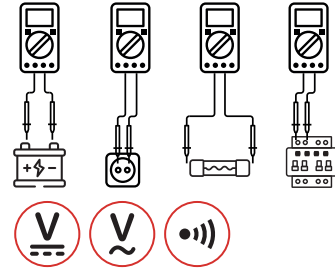

INDUSTRIAL

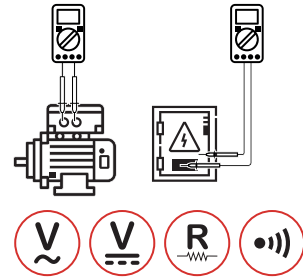

ELECTRONICS

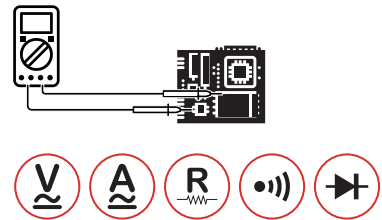

DIGITAL MULTIMETER
MS8265

SKU NO.: MS8265CBGLO
UPC CODE: 810053674772
EAN CODE: 8435394779836

FEATURE

- Auto Power Off.
- Sound & Light Warning.
- Transistor hFE 0~1000.
- Diode Open Voltage 3.0V.

SPECIFICATIONS

AC Voltage 750V	DC Voltage 1000V	AC Current 10A
DC Current 10A	Resistance 200MΩ	Continuity <70Ω
Capacitance 200μF	Frequency 20kHz	Display Counts 20000

CONTENTS



195×92×55mm
7.7"×3.6"×2.2"
400g/0.9lb



1×9V 6F22
Battery



ACCESSORIES

Test leads
Multi-function socket
Battery



Calibration
Certificate



Quick Start
Guide

PACKAGING INFORMATION



Color Box
L165×W70×H225mm



Carton Box
47×37.5×35.5cm



X 20PCS

DIGITAL CLAMP METERS

AC CURRENT | AC/DC CURRENT | LEAKAGE | POWER
SPECIAL APPLICATION





MAIN APPLICATIONS

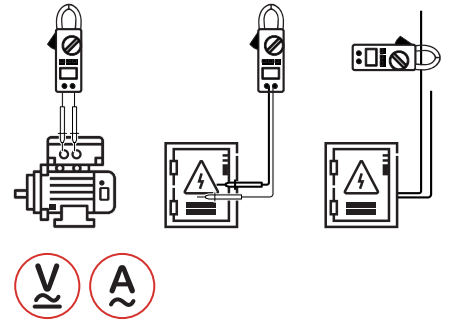
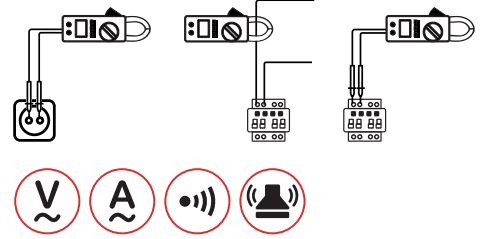

DIGITAL AC ELECTRICAL TESTER
M266

SKU NO.: M266CBGLO
UPC CODE: 810053673287
EAN CODE: 8435394779010

FEATURE

- Data Hold.
- Low Battery Display.

SPECIFICATIONS

AC Voltage 750V	DC Voltage 1000V	AC Current 1000A
Resistance 20kΩ	Display Counts 2000	Continuity <100Ω
Jaw Opening 50mm/2.0"		

CONTENTS



235×96×46mm
9.25"×3.8"×1.8"
268g/0.59lb



1×9V 6F22
Battery



ACCESSORIES

Test Leads
Carry bag
Battery



Calibration
Certificate



Quick Start
Guide

PACKAGING INFORMATION



Color Box
L130×W63×H255mm



Carton Box
53×34×28.5cm



X20PCS



MAIN APPLICATIONS

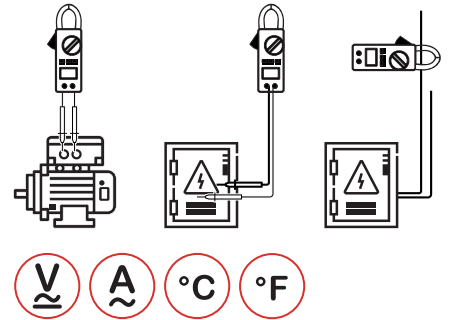
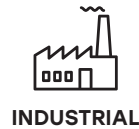
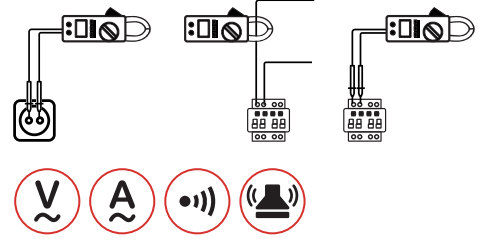

DIGITAL CLAMP TRANSDUCER
M266C

SKU NO.: M266CCBGLO
UPC CODE: 810053672471
EAN CODE: 8435394778112

FEATURE

- Data Hold.
- Low Battery Display.

SPECIFICATIONS

AC Voltage 750V	DC Voltage 1000V	AC Current 1000A
Resistance 2MΩ	Display Counts 2000	Continuity <100Ω
Jaw Opening 50mm/2.0"	Temperature 0°C~750°C/32°F~1382°F	

CONTENTS



235×96×46mm
9.25"×3.8"×1.8"
268g/0.59lb



1×9V 6F22
Battery



Test Leads
K-type thermocouple
Carry bag
Battery



Calibration
Certificate



Quick Start
Guide

PACKAGING INFORMATION



Color Box
L130×W63×H255mm



Carton Box
53×34×28.5cm



X20PCS



MAIN APPLICATIONS

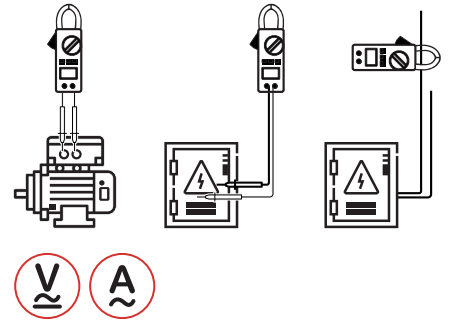
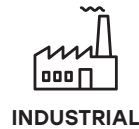
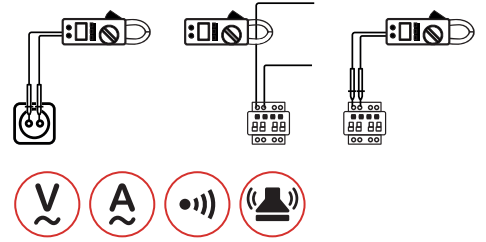

DIGITAL AC CLAMP METER
M266F

SKU NO.: M266FCBGLO
UPC CODE: 810053672488
EAN CODE: 8435394778129

FEATURE

- Diode open voltage 2.7V.
- Data Hold.
- Low Battery Display.

SPECIFICATIONS

AC Voltage 750V	DC Voltage 1000V	AC Current 1000A
Resistance 2MΩ	Frequency 2kHz	Display Counts 2000
Continuity <100Ω	Jaw Opening 50mm/2.0"	

CONTENTS



235×96×46mm
9.25"×3.8"×1.8"
268g/0.59lb



1×9V 6F22
Battery



ACCESSORIES

Test Leads
Carry bag
Battery



Calibration
Certificate



Quick Start
Guide

PACKAGING INFORMATION



Color Box
L130×W63×H255mm



Carton Box
53×34×28.5cm



X20PCS



MAIN APPLICATIONS

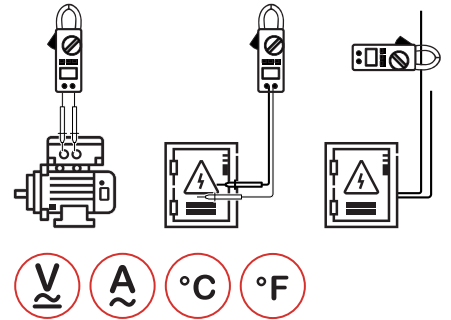
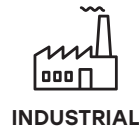
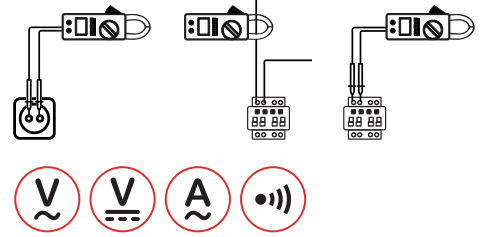

DIGITAL AC CLAMP METER
MS2000G

SKU NO.: MS2000GCBGLO
UPC CODE: 810053674093
EAN CODE: 8435394779164

FEATURE

- Diode Open Voltage 3.0V.
- Data Hold.
- Display Backlight.
- Low Battery Display.

SPECIFICATIONS

AC Voltage 750V	DC Voltage 1000V	AC Current 2000A
Resistance 2MΩ	Frequency 20kHz	Display Counts 2000
Jaw Opening 55mm/2.2"	Continuity <60Ω	
Temperature -0°C~750°C/32°F~1382°F		

CONTENTS



282×104×47mm
11"×4.1"×1.85"
570g/1.26lb



1×9V 6F22
Battery



ACCESSORIES

Test Leads
Wrapping Case
K type thermocouple
Battery



Calibration
Certificate



Quick Start
Guide

PACKAGING INFORMATION



Color Box
L300×W65×H250mm



Carton Box
61.5×37×27cm



X 10PCS



MAIN APPLICATIONS

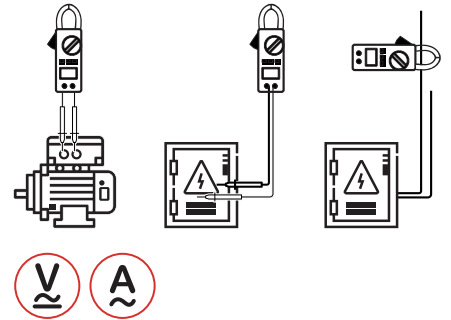
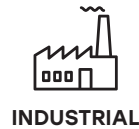
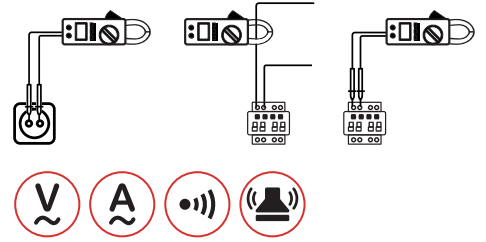

DIGITAL AC CLAMP METER
MS2001

SKU NO.: MS2001CBGLO
UPC CODE: 810053672341
EAN CODE: 8435394778044

FEATURE

- Diode Open Voltage 3.0V.
- Data Hold.
- Display Backlight.
- Low Battery Display.

SPECIFICATIONS

AC Voltage 750V	DC Voltage 1000V	AC Current 1000A
Resistance 2000Ω	Display Counts 2000	Jaw Opening 42mm/1.7"
Continuity <60Ω		

CONTENTS



250×99×43mm
9.8"×3.9"×1.7"
416g/0.92lb



1×9V 6F22
Battery



ACCESSORIES

Test Leads
Wrapping Case
Battery



Calibration
Certificate



Quick Start
Guide

PACKAGING INFORMATION



Color Box
L130×W60×H300mm



Carton Box
35.5×33×29cm



X 10PCS



MAIN APPLICATIONS

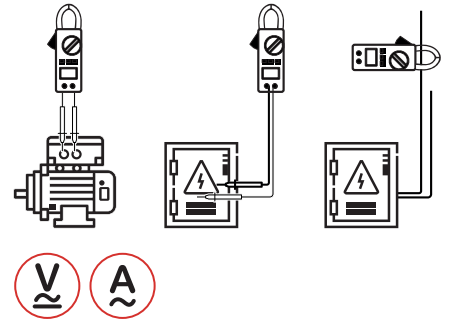
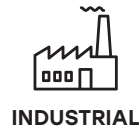
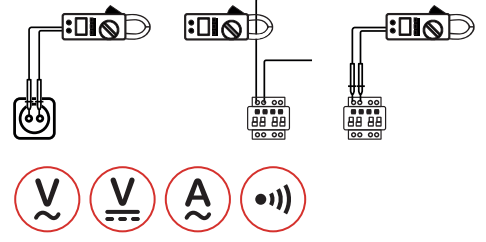

DIGITAL AC CLAMP METER
MS2001F

SKU NO.: MS2001FCBGLO
UPC CODE: 810053673218
EAN CODE: 84835394778945

FEATURE

- Data Hold.
- Diode and Continuity.

SPECIFICATIONS

AC Voltage 750V	DC Voltage 1000V	AC Current 1000A
Resistance 2000Ω	Display Counts 2000	Jaw Opening 42mm/1.7"

CONTENTS



250×99×43mm
9.8"×3.9"×1.7"
416g/0.92lb



1×9V 6F22
Battery



ACCESSORIES

Test Leads
Carry bag
Battery



Calibration
Certificate



Quick Start
Guide

PACKAGING INFORMATION



Color Box
L130×W60×H300mm



Carton Box
35.5×33×29cm



X 10PCS



MAIN APPLICATIONS

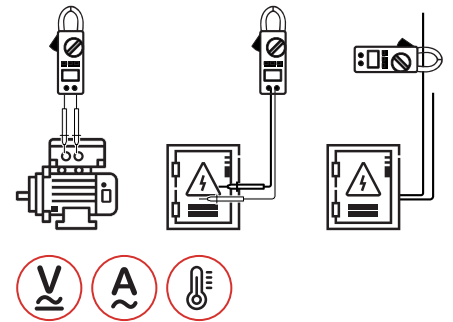
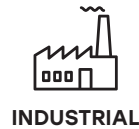
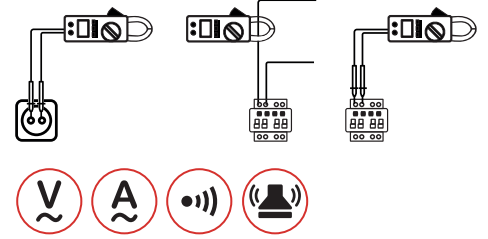

DIGITAL CLAMP METER - TRUE RMS
MS2003A

SKU NO.: MS2003ACBGLO
EAN CODE: 8435394788388

FEATURE

- True RMS / Relative
- MAX / MIN / Diode / Continuity
- Non-Contact Voltage (NCV) Detection
- Live Wire(Live) Recognition

SPECIFICATIONS

AC Voltage 600V	DC Voltage 600V	AC Current 200A
Resistance 40MΩ	Capacitance 4mF	Frequency 10MHz
Jaw Opening 19mm	Display Counts 4000	Temperature -20°C~1000°C

CONTENTS



60x32x178mm
2.4"×1.3"×7.0"
165g/0.36lb



1.5V AAA*2



ACCESSORIES

Carry bag
Test Leads
Temperature probe
Battery



Calibration Certificate



Quick Start Guide

PACKAGING INFORMATION



Color Box
L75×W55×H195mm



Carton Box
58×32.5×22cm



X 40PCS



DIGITAL CLAMP METER - TRUE RMS
MS2003B

SKU NO.: MS2003BCBGLO
EAN CODE: 8435394788371

FEATURE

- True RMS / Relative
- Diode / Continuity
- Non-Contact Voltage (NCV) Detection
- Live Wire(Live) Recognition

SPECIFICATIONS

AC Voltage 600V	DC Voltage 600V	AC Current 200A
Resistance 60MΩ	Capacitance 60mF	Frequency 1kHz
Jaw Opening 19mm	Display Counts 6000	Temperature -20°C~1000°C

MAIN APPLICATIONS

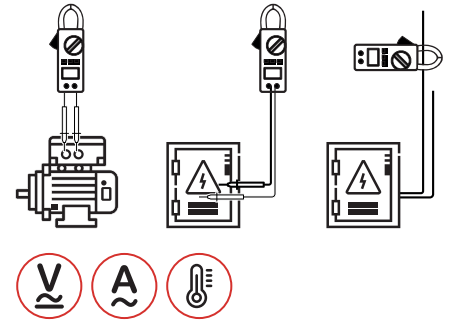
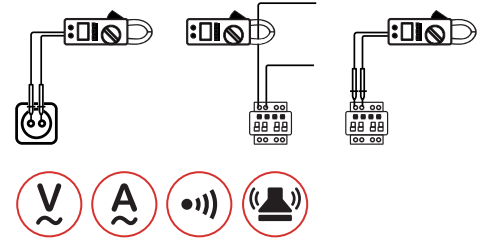

CONTENTS



60x32x178mm
2.4"×1.3"×7.0"
165g/0.36lb



1.5V AAA*2



ACCESSORIES

Carry bag
Test Leads
Temperature probe
Battery



Calibration Certificate



Quick Start Guide

PACKAGING INFORMATION



Color Box
L75×W55×H195mm



Carton Box
58×32.5×22cm



X 40PCS



MAIN APPLICATIONS

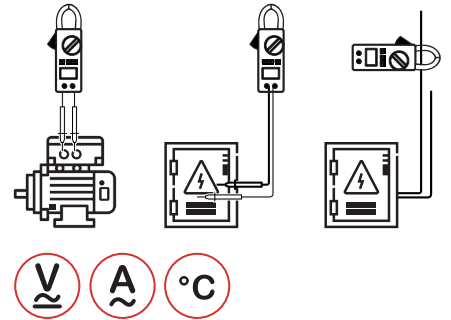
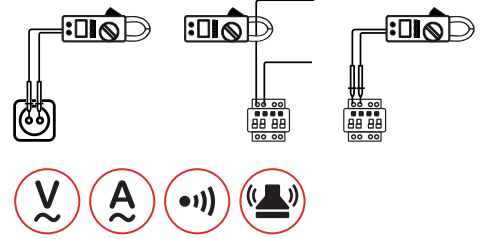

DIGITAL AC CLAMP METER
MS2008B

SKU NO.: MS2008BCBGLO
UPC CODE: 810053674123
EAN CODE: 8435394779195

FEATURE

- Auto & Manual Ranging.
- Auto Power Off.
- Display 4000 Counts.

SPECIFICATIONS

AC Voltage 600V	DC Voltage 600V	AC Current 600A
Resistance 40MΩ	Display Counts 4000	Jaw Opening 26mm/1.0"
Continuity <50Ω	Temperature -20°C~750°C	

CONTENTS



208×78×35mm
8.18"×3.1"×1.4"
240g/0.4lb



3×1.5V AAA
Batteries



Test Leads
K-type thermocouple
Carry bag
Battery



Calibration
Certificate



Quick Start
Guide

PACKAGING INFORMATION



Color Box
L105×W55×H235mm



Carton Box
50×30.5×23cm



X 20PCS



DIGITAL AC CLAMP METER **MS2009A**

SKU NO.: MS2009ACBGLO
UPC CODE: 810053672549
EAN CODE: 8435394778181

FEATURE

- Auto & Manual Ranging.
- Auto Power Off.
- Non-Contact Voltage Detector.
- Diode Open Volatge 1.5V.

SPECIFICATIONS

AC Voltage 600V	DC Voltage 600V	AC Current 600A
Resistance 20MΩ	Display Counts 2000	Jaw Opening 26mm/1.0"
Continuity <60Ω		

MAIN APPLICATIONS

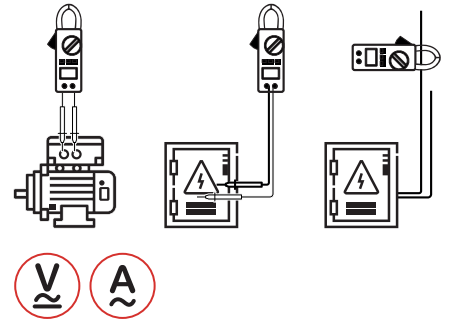
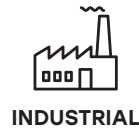
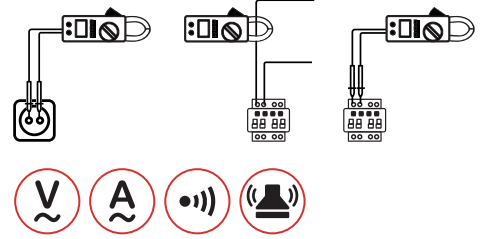

CONTENTS



218×78×35mm
8.9"×3.1"×1.4"
239g/0.53lb



3×1.5V AAA
Batteries



Test Leads
Carry bag
Battery



Calibration
Certificate



Quick Start
Guide

PACKAGING INFORMATION



Color Box
L105×W55×H235mm



Carton Box
50×30.5×23cm



X 20PCS



MAIN APPLICATIONS

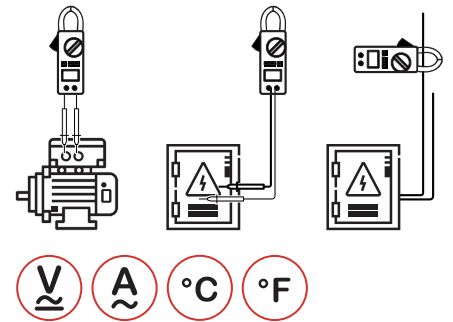
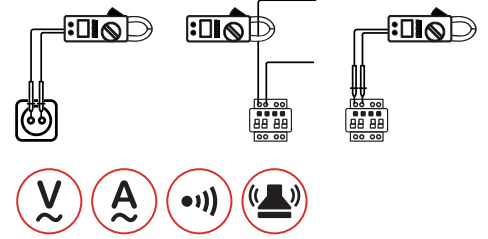

DIGITAL AC CLAMP METER
MS2009C

SKU NO.: MS2009CCBGLO
UPC CODE: 810053674130
EAN CODE: 8435394779201

FEATURE

- Auto & Manual Ranging.
- Auto Power Off.
- Non-Contact Voltage Detector.
- Diode Open Voltage 3.2V.

SPECIFICATIONS

AC Voltage 600V	DC Voltage 600V	AC Current 600A
Resistance 60MΩ	Capacitance 60mF	Frequency 10MHz
Display Counts 6000	Jaw Opening 26mm/1.0"	Continuity <50Ω
Temperature -20°C~1000°C/-4°F~1832°F		

CONTENTS



218×78×35mm
8.9"×3.1"×1.4"
239g/0.53lb



3×1.5V AAA
Batteries



Test Leads
K-type thermocouple
Carry bag
Battery



Calibration
Certificate



Quick Start
Guide

PACKAGING INFORMATION



Color Box
L105×W55×H235mm



Carton Box
50×30.5×23cm



X 20PCS



MAIN APPLICATIONS

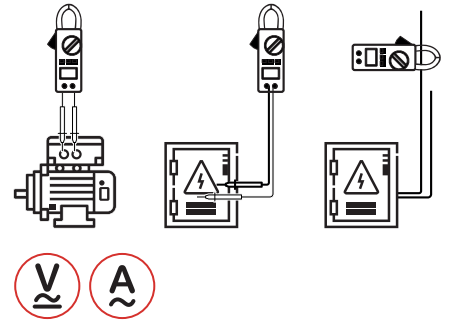
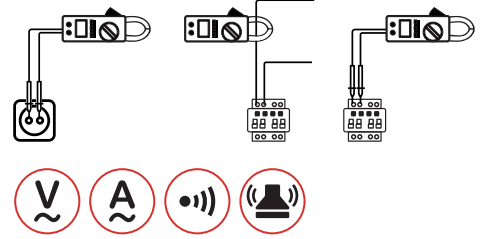

DIGITAL CLAMP METER
MS2015A

SKU NO.: MS2015ACBGLO
UPC CODE: 810053673256
EAN CODE: 8435394778983

FEATURE

- Display 6000 Counts.
- Auto & Manual Ranging.
- Non-Contact Voltage Detector.

SPECIFICATIONS

AC Voltage 750V	DC Voltage 1000V	AC Current 1000A
Resistance 60MΩ	Capacitance 100mF	Frequency(A) 10MHz
Display Counts 6000	Jaw Opening 40mm/1.6"	

CONTENTS



82×42×32mm
3.2"×1.65"×1.26"
45g/0.1lb



1×9V 6F22
Battery



ACCESSORIES

Test Leads
Carry bag
Battery



Calibration
Certificate



Quick Start
Guide

PACKAGING INFORMATION



Color Box
L130×W63×H255mm



Carton Box
53×34×28.5mm



X 20PCS



MAIN APPLICATIONS

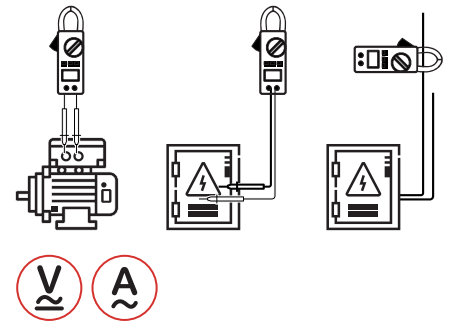
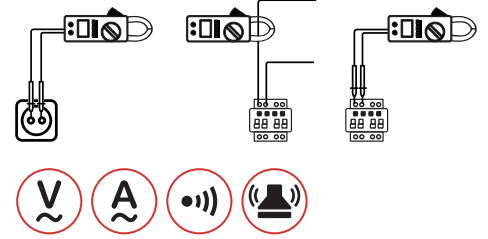

DIGITAL AC CLAMP METER
MS2028A

SKU NO.: MS2028ACBGLO
UPC CODE: 810053674642
EAN CODE: 8435394779706

FEATURE

- Auto & Manual Ranging.
- Auto Power Off.
- Diode Open Voltage 1.5V.
- True Root Mean Square.

SPECIFICATIONS

AC Voltage 600V	DC Voltage 600V	DC Current 600A
Resistance 20MΩ	Display Counts 2000	Jaw Opening 26mm/1.0"
Continuity <50Ω		

CONTENTS



208×78×35mm
8.2"×3.1"×1.4"
245g/0.54lb



3×1.5V AAA
Batteries



ACCESSORIES

Test Leads
Carry bag
Battery



Calibration
Certificate



Quick Start
Guide

PACKAGING INFORMATION



Color Box
L105×W55×H235mm



Carton Box
50×30.5×23cm



X 20PCS



MAIN APPLICATIONS

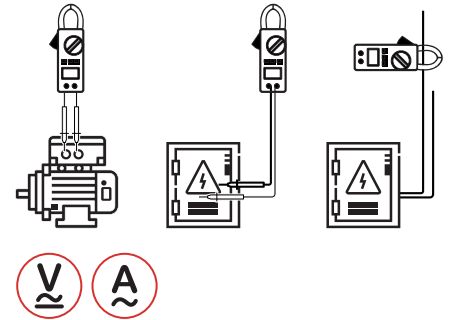
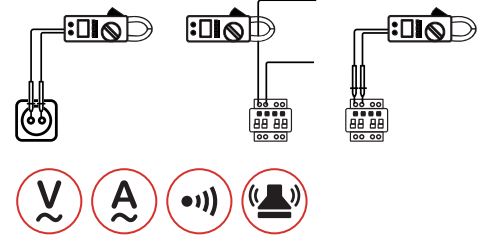

DIGITAL AC CLAMP METER
MS2030

SKU NO.: MS2030CBGLO
UPC CODE: 810053672556
EAN CODE: 8435394778198

FEATURE

- Diode Open Voltage 4.5V.
- Data Hold.
- Low Battery Display.

SPECIFICATIONS

AC Voltage 600V	DC Voltage 600V	AC Current 400A
Resistance 2kΩ	Display Counts 2000	Jaw Opening 28mm/1.1"
Continuity <50±20Ω		

CONTENTS



198×79×38mm
7.8"×3.1"×1.5"
195g/0.43lb



3×1.5V AAA
Batteries



ACCESSORIES

Test Leads
Carry bag
Battery



Calibration
Certificate



Quick Start
Guide

PACKAGING INFORMATION



Color Box
L105×W55×H235mm



Carton Box
50×30.5×23cm



X 20PCS



MAIN APPLICATIONS

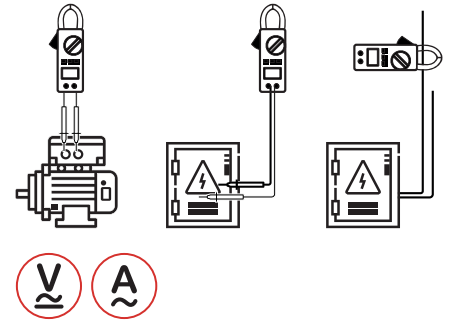
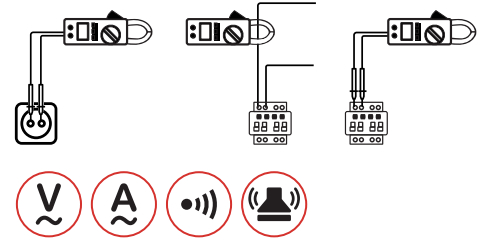

SMART DIGITAL CLAMP METER
MS2033A

SKU NO.: MS2033ACBGLO
UPC CODE: 810053674932
EAN CODE: 8435394782676

FEATURE

- Auto Ranging.
- Auto Power Off.
- Dual Display.
- MAX/MIN.

SPECIFICATIONS

AC Voltage 600V	DC Voltage 600V	AC Current 600A
Resistance 10MΩ	Frequency 3kHz	Display Counts 6000
Jaw Opening 26mm/1.0"	Continuity <40Ω	

CONTENTS



204x78x43mm
8"x3.07"x1.77"
195g/0.43lb



3x1.5V AAA
Batteries



ACCESSORIES

Test Leads
Carry bag
Battery



Calibration
Certificate



Quick Start
Guide

PACKAGING INFORMATION



Color Box
L105xW55xH235mm



Carton Box
50x30.5x23cm



X 20PCS



DIGITAL CLAMP METER
MS2109B

SKU NO.: MS2109BCBGLO
EAN CODE: 8435394788418

FEATURE

- LED / Flashlight / LPF(ACV)
- Overload Protection
- Non-Contact Voltage (NCV) Detection
- Live Wire(Live) Recognition

SPECIFICATIONS

AC Voltage 600V	DC Voltage 600V	AC Current 600A
Resistance 20MΩ	Display Counts 2000	Jaw Opening 23mm

MAIN APPLICATIONS

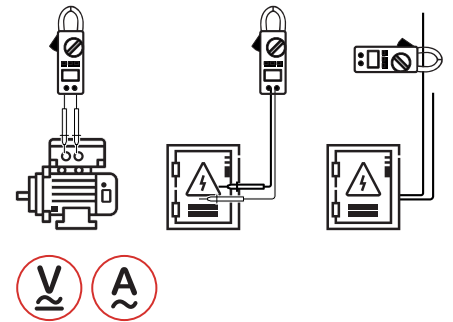
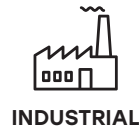
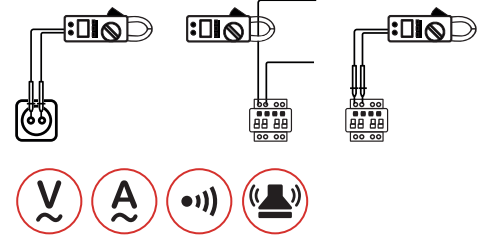

CONTENTS



72x35x194mm
2.8"×1.4"×7.6"
320g/0.7lb



1.5V AAA*3



ACCESSORIES

Carry bag
Test Leads
Temperature probe
Battery



Calibration Certificate



Quick Start Guide

PACKAGING INFORMATION



Color Box
L146×W45×H225mm



Carton Box
50×31.5×25cm



X 20PCS



MAIN APPLICATIONS

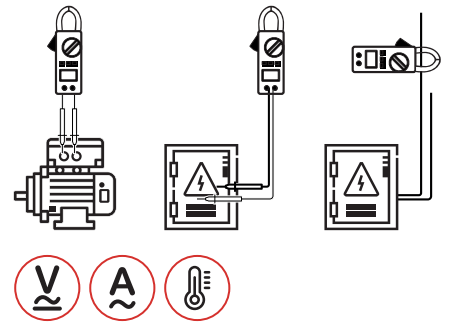
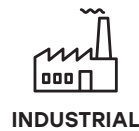
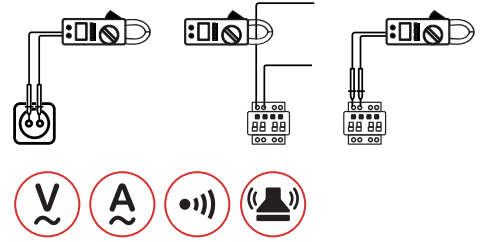

DIGITAL CLAMP METER - TRUE RMS
MS2109C

SKU NO.: MS2109CCBGLO
EAN CODE: 8435394788425

FEATURE

- True RMS / Relative / LED / Flashlight
- Overload Protection
- Non-Contact Voltage (NCV) Detection
- Live Wire(Live) Recognition

SPECIFICATIONS

AC Voltage 600V	DC Voltage 600V	AC Current 600A
Resistance 40MΩ	Frequency 10MHz	Capacitance 10mF
Jaw Opening 23mm	Display Counts 4000	Temperature -20°C~1000°C

CONTENTS



72x35x194mm
2.8"×1.4"×7.6"
320g/0.7lb



1.5V AAA*3



ACCESSORIES

Carry bag
Test Leads
Temperature probe
Battery



Calibration Certificate



Quick Start Guide

PACKAGING INFORMATION



Color Box
L146×W45×H225mm



Carton Box
50×31.5×25cm



X 20PCS



MAIN APPLICATIONS

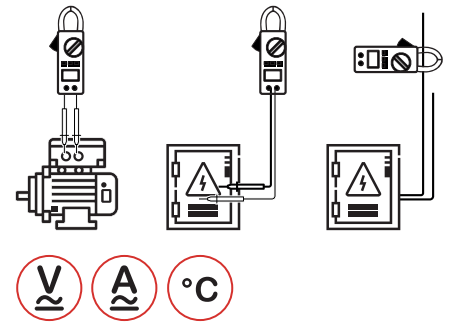
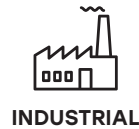
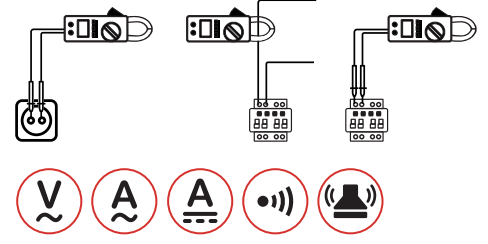

DIGITAL AC/DC CLAMP METER
MS2101

SKU NO.: MS2101CBGLO
UPC CODE: 810053672105
EAN CODE: 8435394777832

FEATURE

- Auto and Manual Ranging.
- Auto Power Off.
- Diode Open Voltage 2.2V.
- Data Hold.

SPECIFICATIONS

AC Voltage 750V	DC Voltage 1000V	AC Current 1000A
DC Current 1000A	Resistance 40MΩ	Capacitance 100μF
Frequency 100kHz	Display Counts 4000	Jaw Opening 42mm/1.7"
Continuity <50Ω±20Ω	Temperature -40°C~750°C	

CONTENTS



250×99×43mm
9.8"×3.9"×1.7"
416g/0.92lb



1×9V 6F22
Battery



ACCESSORIES

Test Leads
K-type thermocouple
Carry bag
Battery



Calibration
Certificate



Quick Start
Guide

PACKAGING INFORMATION



Color Box
L130×W60×H300mm



Carton Box
35.5×33×29cm



X 10PCS



MAIN APPLICATIONS

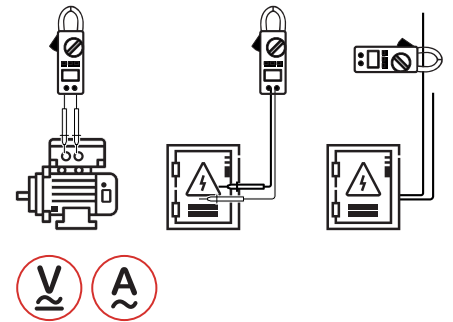
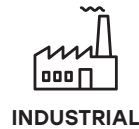
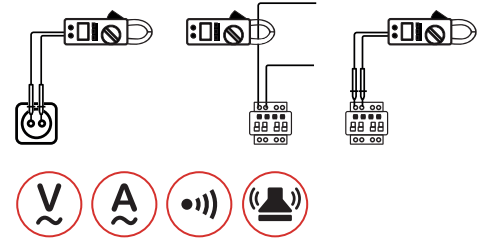

DIGITAL CLAMP METER - TRUE RMS
MS2103A

SKU NO.: MS2103ACBGLO
EAN CODE: 8435394788395

FEATURE

- True RMS / Relative / Diode / Continuity
- 600mA Fuse
- Non-Contact Voltage (NCV) Detection
- Live Wire(Live) Recognition

SPECIFICATIONS

AC Voltage 600V	DC Voltage 600V	AC Current 200A
DC Current 200A	Capacitance 60mF	Frequency 1MHz
Jaw Opening 19mm	Display Counts 6000	Resistance 60MΩ

CONTENTS



60x32x178mm
2.4" x 1.3" x 7.0"
165g/0.36lb



1.5V AAA*2



ACCESSORIES

Carry bag
Test Leads
Temperature probe
Battery



Calibration Certificate



Quick Start Guide

PACKAGING INFORMATION



Color Box
L75xW55xH195mm



Carton Box
58x32.5x22cm



X 40PCS



DIGITAL CLAMP METER - TRUE RMS
MS2103B

SKU NO.: MS2103BCBGLO
EAN CODE: 8435394788401

FEATURE

- True RMS / Relative / Diode / Continuity
- MAX / MIN
- Non-Contact Voltage (NCV) Detection
- Live Wire(Live) Recognition

SPECIFICATIONS

AC Voltage 600V	DC Voltage 600V	AC Current 200A
DC Current 200A	Resistance 40MΩ	Capacitance 4mF
Frequency 10MHz	Jaw Opening 19mm	Display Counts 4000
Temperature -20°C~1000°C		

MAIN APPLICATIONS

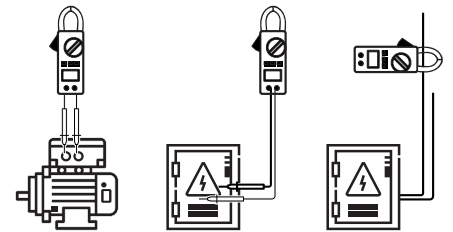
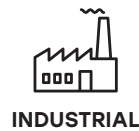
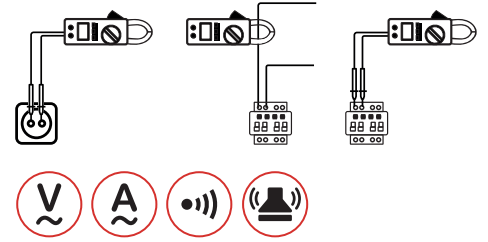

CONTENTS



60x32x178mm
2.4"×1.3"×7.0"
165g/0.36lb



1.5V AAA*2



ACCESSORIES

Carry bag
Test Leads
Temperature probe
Battery



Calibration Certificate



Quick Start Guide

PACKAGING INFORMATION



Color Box
L75×W55×H195mm



Carton Box
58×32.5×22cm



X 40PCS



MAIN APPLICATIONS

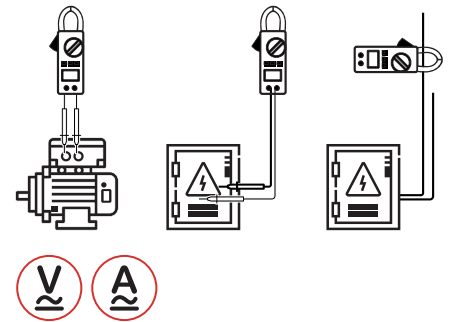
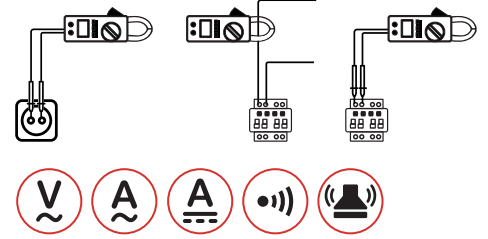

DIGITAL AC/DC CLAMP METER
MS2108

SKU NO.: MS2108CBGLO
UPC CODE: 810053673232
EAN CODE: 8435394778969

FEATURE

- Auto & Manual Ranging.
- Auto Power Off.
- Inrush 100ms Current Integral.
- True Root Mean Square.

SPECIFICATIONS

AC Voltage 600V	DC Voltage 600V	AC Current 600A
DC Current 600A	Resistance 66MΩ	Capacitance 66mF
Frequency 10kHz	Display Counts 6600	

CONTENTS



208x78x53mm
8.2"×3.1"×1.4"
245g/0.54lb



3×1.5V AAA
Batteries



ACCESSORIES

Test Leads
Carry bag
Battery



Calibration
Certificate



Quick Start
Guide

PACKAGING INFORMATION



Color Box
L105×W55×H235mm



Carton Box
50×30.5×23cm



X 20PCS



DIGITAL AC/DC CLAMP METER
MS2109A

SKU NO.: MS2109ACBGLO
UPC CODE: 810053672112
EAN CODE: 8435394777849

FEATURE

- Auto Ranging.
- Auto Power Off.
- Non-Contact Voltage Detector.
- Relative Measurement.

SPECIFICATIONS

AC Voltage 600V	DC Voltage 600V	AC Current 600A
DC Current 600A	Resistance 60MΩ	Capacitance 4000μF
Frequency 10MHz	Display Counts 6000	Jaw Opening 26mm/1.0"
Temperature -20°C~1000°C/-4°F~1832°F		Continuity <50±20Ω

MAIN APPLICATIONS

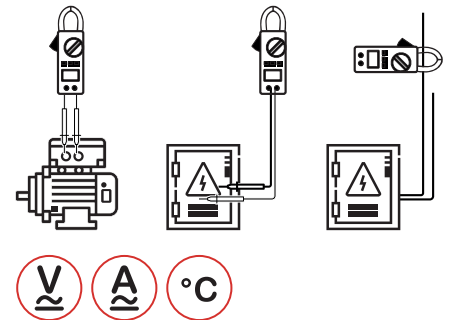
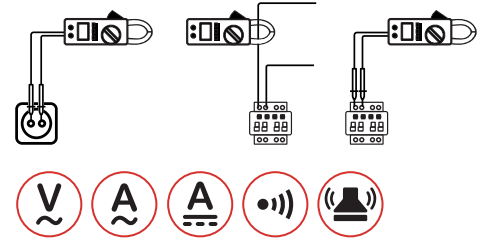

CONTENTS



218×78×35mm
8.9"×3.1"×1.4"
239g/0.53lb



3×1.5V AAA
Batteries



Test Leads
K-type thermocouple
Carry bag
Battery



Calibration
Certificate



Quick Start
Guide

PACKAGING INFORMATION



Color Box
L105xW55xH235mm



Carton Box
50×30.5×23cm



X 20PCS



MAIN APPLICATIONS

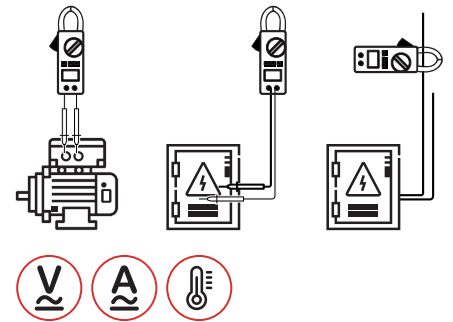
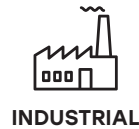
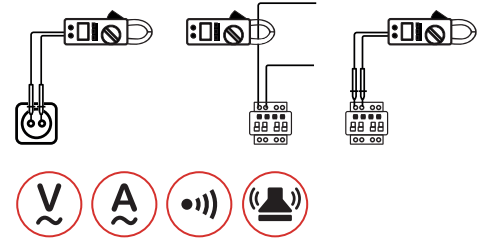

DIGITAL CLAMP METER - TRUE RMS
MS2109D

SKU NO.: MS2109DCBGLO
EAN CODE: 8435394788432

FEATURE

- True RMS / Relative / LED / Flashlight
- Overload Protection
- Non-Contact Voltage (NCV) Detection
- Live Wire(Live) Recognition

SPECIFICATIONS

AC Voltage 750V	DC Voltage 1000V	AC Current 1000A
DC Current 1000A	Resistance 60MΩ	Frequency 10MHz
Capacitance 10mF	Jaw Opening 23mm	Display Counts 6000
Temperature -20°C~1000°C		

CONTENTS



72x35x194mm
2.8"×1.4"×7.6"
320g/0.7lb



1.5V AAA*3



ACCESSORIES

Carry bag
Test Leads
Temperature probe
Battery



Calibration Certificate



Quick Start Guide

PACKAGING INFORMATION



Color Box
L146×W45×H225mm



Carton Box
50×31.5×25cm



X 20PCS



DIGITAL CLAMP METER - TRUE RMS
MS2115A

SKU NO.: MS2115ACBGLO
UPC CODE: 810053672051
EAN CODE: 8435394777788

FEATURE

- Auto Power Off.
- Low Battery Display.
- MAX/MIN.

SPECIFICATIONS

AC Voltage 750V	DC Voltage 1000V	AC Current 1000A
DC Current 1000A	Resistance 60MΩ	Capacitance 100mF
Frequency 10MHz	Display Counts 6000	Continuity <50Ω

MAIN APPLICATIONS

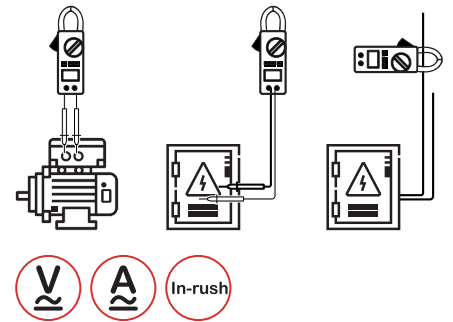
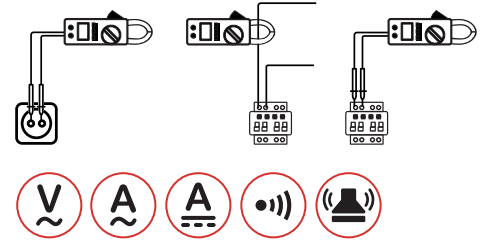

CONTENTS



238×92×50mm
9.3"×3.62"×1.96"
420g/0.7lb



1×9V 6F22
Battery



ACCESSORIES

Test Leads
Carry bag
Battery



Calibration
Certificate



Quick Start
Guide

PACKAGING INFORMATION



Color Box
L130×W63×H255mm



Carton Box
53×34×28.5mm



X 20PCS



MAIN APPLICATIONS

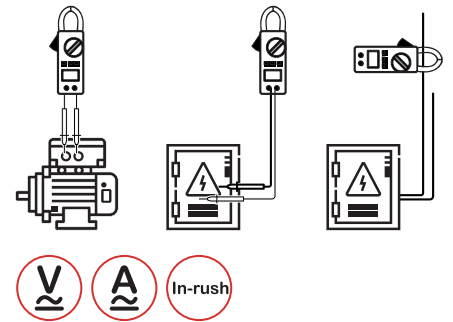
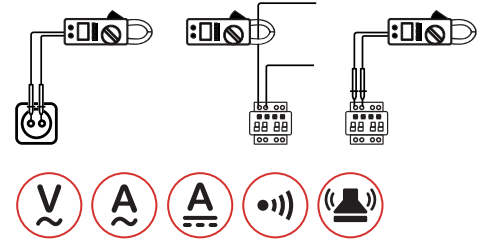

DIGITAL AC/DC CLAMP METER
MS2128

SKU NO.: MS2128CBGLO
UPC CODE: 810053674178
EAN CODE: 8435394779249

FEATURE

- Auto & Manual Ranging.
- Auto Power Off.
- Inrush 100ms Current Integral.
- True Root Mean Square.

SPECIFICATIONS

AC Voltage 600V	DC Voltage 600V	AC Current 600A
DC Current 600A	Resistance 66MΩ	Capacitance 66mF
Frequency(A) 1kHz	Frequency(V) 10kHz	Display Counts 6600
Jaw Opening 26mm/1.0"	Continuity <50±20Ω	

CONTENTS



208×78×53mm
8.2"×3.1"×1.4"
245g/0.54lb



3×1.5V AAA
Batteries



ACCESSORIES

Test Leads
Carry bag
Battery



Calibration
Certificate



Quick Start
Guide

PACKAGING INFORMATION



Color Box
L105×W55×H235mm



Carton Box
50×30.5×23cm



X 20PCS



DIGITAL AC/DC CLAMP METER
MS2138

SKU NO.: MS2138CBGLO
UPC CODE: 810053672136
EAN CODE: 8435394778464

FEATURE

- Auto & Manual Ranging.
- Auto Power Off.
- Diode Open Voltage 2.8V.
- Relative Measurement.

SPECIFICATIONS

AC Voltage 600V	DC Voltage 600V	AC Current 1000A
DC Current 1000A	Resistance 40MΩ	Capacitance 4000μF
Frequency 10MHz	Display Counts 4000	Jaw Opening 40mm/1.6"
Continuity <50±20Ω		

MAIN APPLICATIONS

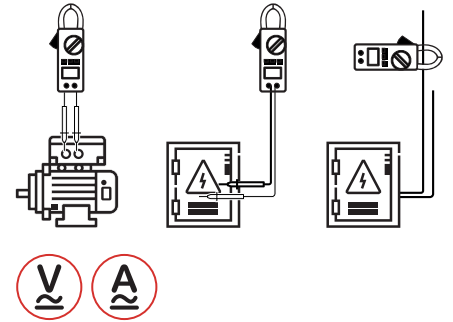
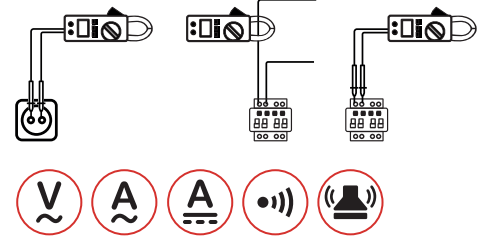

CONTENTS



222×86×32mm
8.74"×3.38"×1.26"
323g/0.71lb



3×1.5V AAA
Batteries



ACCESSORIES

Test Leads
Carry bag
Battery



Calibration
Certificate



Quick Start
Guide

PACKAGING INFORMATION



Color Box
L130×W63×H255mm



Carton Box
53×34×28.5mm



X 20PCS



MAIN APPLICATIONS

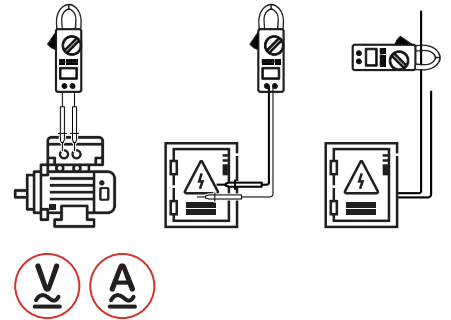
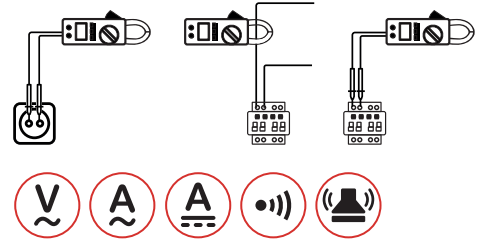

DIGITAL AC/DC CLAMP METER (T-RMS)
MS2138R

SKU NO.: MS2138RCBGLO
UPC CODE: 810053672143
EAN CODE: 8435394777863

FEATURE

- Auto & Manual Ranging.
- Auto Power Off.
- Diode Open Voltage 2.8V.
- Relative Measurement.

SPECIFICATIONS

AC Voltage 600V	DC Voltage 600V	AC Current 1000A
DC Current 1000A	Resistance 40MΩ	Capacitance 4000μF
Frequency 10MHz	Continuity test <50±20Ω	Display Counts 4000
Jaw Opening 40mm/1.6"		

CONTENTS



222×86×32mm
8.74"×3.38"×1.26"
323g/0.71lb



3×1.5V AAA
Batteries



ACCESSORIES

Test Leads
Carry bag
Battery



Calibration
Certificate



Quick Start
Guide

PACKAGING INFORMATION



Color Box
L130×W63×H255mm



Carton Box
53×34×28.5mm



X 20PCS



MAIN APPLICATIONS

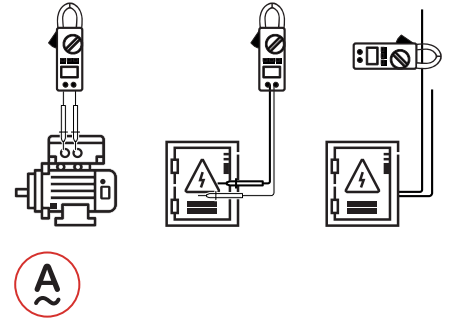

**HIGH SENSITIVITY
AC LEAKAGE CLAMP METER
MS2006B**

SKU NO.: MS2006BCBGLO
UPC CODE: 810053672532
EAN CODE: 8435394778174

FEATURE

- Auto Power Off.
- Data Hold.
- Low Battery Display.

SPECIFICATIONS

AC Current 60A	Display Counts 2000	Jaw Opening 31mm/1.2"
--------------------------	-------------------------------	---------------------------------

CONTENTS



176×59×28mm
6.9"×2.3"×1.1"
150g/0.33lb



2×1.5V AAA
Batteries



Carry bag
Battery

ACCESSORIES



Calibration
Certificate



Quick Start
Guide

PACKAGING INFORMATION



Color Box
L75×W45×H190mm



Carton Box
45×33×29.5cm



X 50PCS



MAIN APPLICATIONS

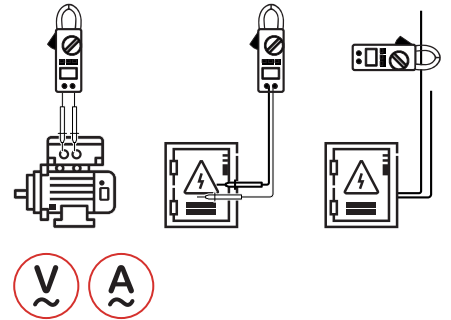
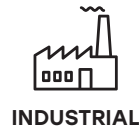
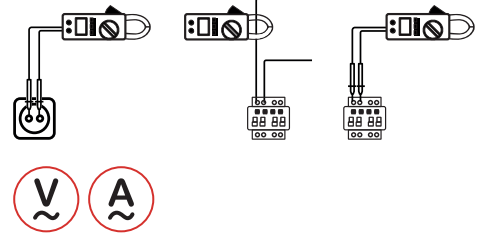

THREE PHASE DIGITAL POWER CLAMP METER
MS2205

SKU NO.: MS2205CBAGLO
UPC CODE: 810053674192
EAN CODE: 8435394779263

FEATURE

- Auto & Manual Ranging.
- Auto Power Off.
- Data Hold.
- True Root Mean Square.

SPECIFICATIONS

AC Voltage 600V	AC Current 1000A	Frequency 1000Hz
Active Power 600kW	Apparent Power 600kVA	Reactive Power 600kVAR
Jaw Opening 50mm/2.0"	Display Counts 6000	

CONTENTS



300x103x51mm
11.8"x4.1"x2.0"
640g/1.4lb



4x1.5V AAA
Batteries



ACCESSORIES

Test Leads
Alligator clip
RS232C interface cable
PC data record graph
software
Carry Case
Battery



Calibration
Certificate



Quick Start
Guide

PACKAGING INFORMATION



Color Box
L370xW140xH324mm



Carton Box
58x39x35cm



X 4PCS



MAIN APPLICATIONS

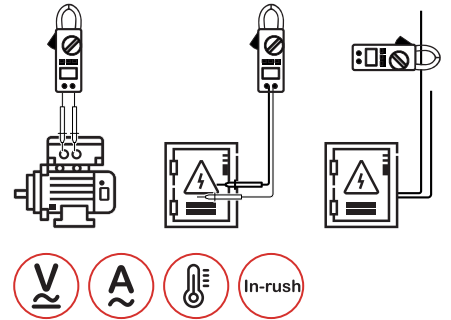
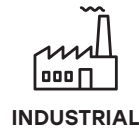
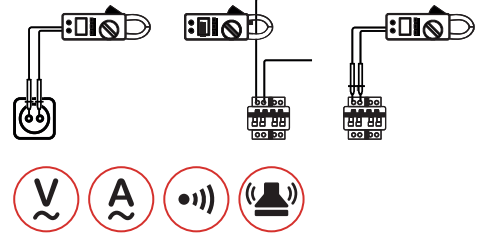

SINGLE PHASE POWER CLAMP METER
MS2225A

SKU NO.: MS2225ACBGLO
UPC CODE: 810053674680
EAN CODE: 8435394779744

FEATURE

- Auto & Manual Ranging.
- Auto Power Off.
- True Root Mean Square.
- Diode Open voltage 3.2V.

SPECIFICATIONS

AC Voltage 750V	DC Voltage 1000V	AC Current 1000A
Resistance 60MΩ	Capacitance 100mF	Continuity <50Ω
Frequency 10MHz	Display Counts 6000	Jaw Opening 40mm/1.6"

CONTENTS



250×98×53mm
9.84"×3.78"×2.09"
450g/0.99lb



1×9V 6F22
Battery



ACCESSORIES

Test Leads
Carry bag
Battery



Calibration
Certificate

Alligator clip
(option)



Quick Start
Guide

PACKAGING INFORMATION



Color Box
L130×W63×H255mm



Carton Box
53×34×28.5mm



X 20PCS



MAIN APPLICATIONS

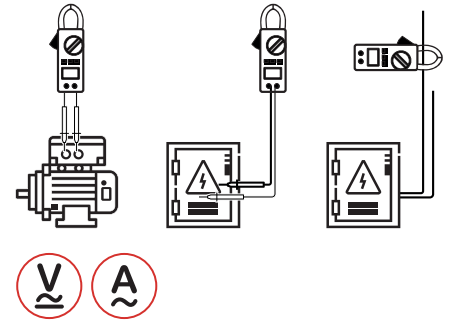
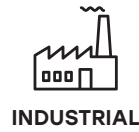
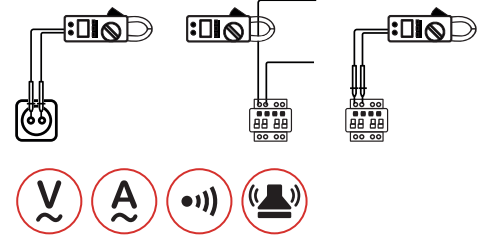

AC/DC CLAMP METER
M9912

SKU NO.: M9912CBAGLO
UPC CODE: 810053674079
EAN CODE: 8435394779140

FEATURE

- Diode and Continuity.
- Display Backlight.
- Data Hold.

SPECIFICATIONS

AC Voltage 750V	DC Voltage 750V	AC Current 1000A
DC Current 1000A	Resistance 30MΩ	Frequency 30kHz
Display Counts 3200	Jaw Opening 55mm/2.2"	

CONTENTS



282x104x47mm
11.1"x4.09"x1.85"
500g/0.83lb



1x9V 6F22
Battery



ACCESSORIES

Test Leads
Carry bag
Battery



Calibration
Certificate



Quick Start
Guide

PACKAGING INFORMATION



Color Box
L300xW65xH250mm



Carton Box
61.5x37x27cm



X 10PCS



MAIN APPLICATIONS

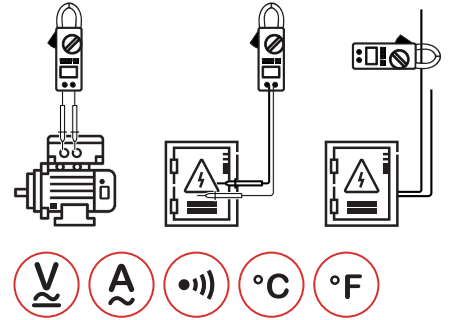

CONTENTS



201×65×43mm
7.7"×2.6"×1.7"
265g/0.58lb



1×9V 6F22
Battery



ACCESSORIES

Test Leads
K type thermocouple
Carry bag
Battery



Calibration
Certificate



Quick Start
Guide

DIGITAL AC CLAMP METER
MS2601

SKU NO.: MS2601CBGLO
UPC CODE: 810053674215
EAN CODE: 8435394779287

FEATURE

- Auto & Manual Ranging.
- Auto Power Off.
- Non-Contact Voltage Detector.
- Diode Open Voltage 3.2V.

SPECIFICATIONS

AC Voltage 600V	DC Voltage 600V	AC Current 200A
Resistance 60MΩ	Capacitance 60mF	Frequency(A/V) 60Hz/60MHz
Display counts 6000	Jaw opening 12mm/0.5"	Continuity <50Ω
Temperature -20°C~400°C/-4°F~752°F		

PACKAGING INFORMATION



Color Box
L172×W80×H255mm



Carton Box
53×44.5×37cm



X 20PCS



MAIN APPLICATIONS

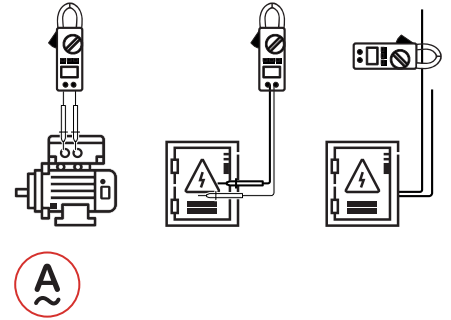
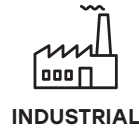

CONTENTS



143×64×30mm
5.6"×2.5"×1.2"
185g/0.4lb



Calibration Certificate



ACCESSORIES

Wrapping Case



Quick Start Guide

DIGITAL CLAMP TRANSDUCER

MS3302

SKU NO.: MS3302CBGLO
UPC CODE: 810053674697
EAN CODE: 8435394784311

FEATURE

- Jaw Opening Φ 28mm/1.1".

SPECIFICATIONS

AC Current
400A

Output
1mV/A

PACKAGING INFORMATION



Color Box
L115×W55×H165mm



Carton Box
47.5×34.5×32cm



X 40PCS

AC LINE SPLITTERS

USA TYPE | EU TYPE | UK TYPE

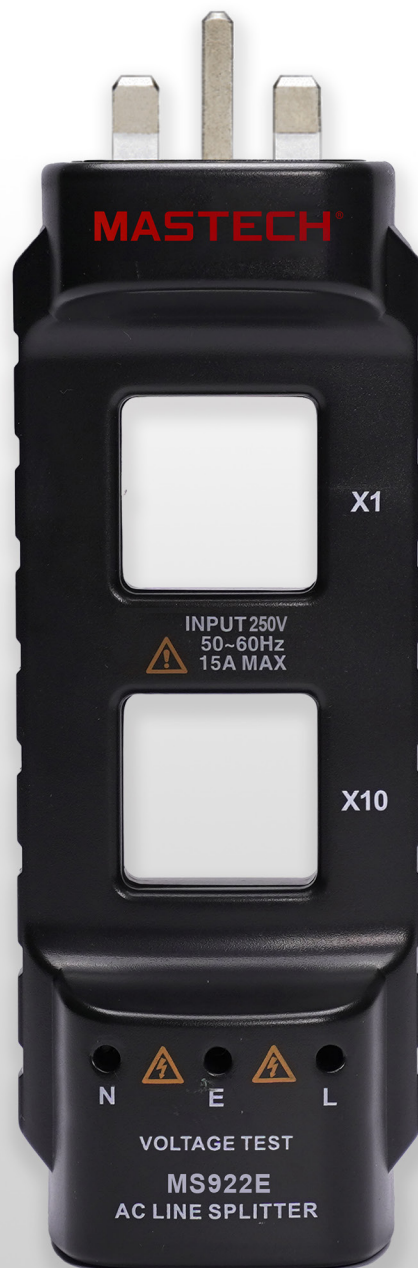



AC LINE SPLITTER

MS922A

SKU NO.: MS922ACBGLO
 UPC CODE: 810053675380
 EAN CODE: 8435394783420

FEATURE

- Allows for Easy AC Current Measurements Using a Clamp Meter on 2 or 3 Wire Power Cords.
- Voltage Check Sockets for Easy Power Calculations.

SPECIFICATIONS

AC Voltage 125V	AC Current 15A
---------------------------	--------------------------

MAIN APPLICATIONS

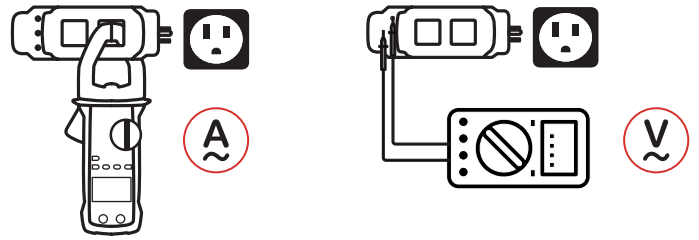

CONTENTS



171x57x48mm
 6.7"x2.2"x1.9"
 131g/0.29lb



Calibration Certificate



Quick Start Guide

PACKAGING INFORMATION



Color Box
 L85xW65xH230mm



Carton Box
 48x34.5x36.5cm



X 40PCS



AC LINE SPLITTER

MS922D

SKU NO.: MS922DCBGLO
 UPC CODE: 810053675397
 EAN CODE: 8435394783437

FEATURE

- Allows for Easy AC Current Measurements Using a Clamp Meter on 2 or 3 Wire Power Cords.
- Voltage Check Sockets for Easy Power Calculations.

SPECIFICATIONS

AC Voltage 250V	AC Current 15A
---------------------------	--------------------------

MAIN APPLICATIONS

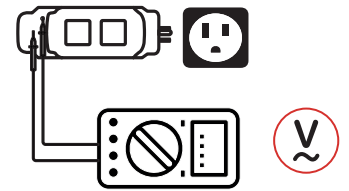
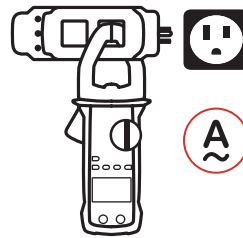

CONTENTS



200x57x48mm
 7.8"x2.2"x2.9"
 140g/0.3lb



Calibration Certificate



Quick Start Guide

PACKAGING INFORMATION



Color Box
 L85xW65xH230mm



Carton Box
 48x34.5x36.5cm



X 40PCS



AC LINE SPLITTER

MS922E

SKU NO.: MS922ECBGLO
 UPC CODE: 810053675403
 EAN CODE: 8435394783444

FEATURE

- Allows for Easy AC Current Measurements Using a Clamp Meter on 2 or 3 Wire Power Cords.
- Voltage Check Sockets for Easy Power Calculations.

SPECIFICATIONS

AC Voltage 250V	AC Current 15A
---------------------------	--------------------------

MAIN APPLICATIONS

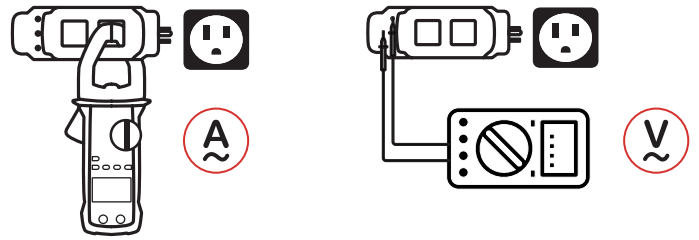

CONTENTS



173x57x48mm
 6.8"x2.2"x1.9"
 131g/0.29lb



Calibration Certificate



Quick Start Guide

PACKAGING INFORMATION



Color Box
 L85xW65xH230mm



Carton Box
 48x34.5x36.5cm



X 40PCS

ELECTRICAL TESTERS

NON CONTACT VOLTAGE TESTER

TWO POLE VOLTAGE TESTER





NON CONTACT AC VOLTAGE DETECTOR
MS8900

SKU NO.: MS8900CBGLO
 UPC CODE: 810053672723
 EAN CODE: 8435394778365

FEATURE

- Sound and Light Instruction.
- Double Molded Case.

SPECIFICATIONS

AC Voltage 100~240V	Frequency 50Hz~60Hz
-------------------------------	-------------------------------

MAIN APPLICATIONS

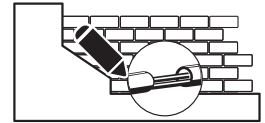

CONTENTS



157×24×20mm
 6.18"×0.94"×0.78"
 42g/0.09lb



2×1.5V AAA
 Batteries



ACCESSORIES

Battery



Calibration
 Certificate



Quick Start
 Guide

PACKAGING INFORMATION



Color Box
 L82×W40×H184mm



Carton Box
 39×22×35.5cm



X 40PCS



NON CONTACT AC VOLTAGE DETECTOR MS8900A

SKU NO.: MS8900ACBGLO
UPC CODE: 810053673041
EAN CODE: 8435394778778

FEATURE

- Sound and Light Instruction.
- Double Molded Case.

SPECIFICATIONS

AC Voltage
90~1000V

Frequency
50Hz~60Hz

MAIN APPLICATIONS

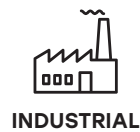
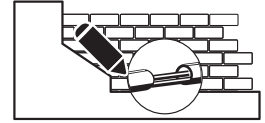

CONTENTS



157×24×20mm
6.18"×0.94"×0.78"
42g/0.09lb



2×1.5V AAA
Batteries



ACCESSORIES

Battery



Calibration
Certificate



Quick Start
Guide

PACKAGING INFORMATION



Color Box
L82×W40×H184mm



Carton Box
39×22×35.5cm



X 40PCS



MAIN APPLICATIONS

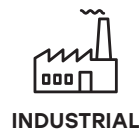
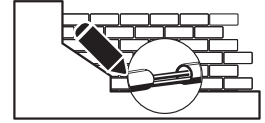

NON CONTACT AC VOLTAGE DETECTOR
MS8902B

SKU NO.: MS8902BCBGLO
UPC CODE: 810053674505
EAN CODE: 8435394779577

FEATURE

- Sound and Light Instruction.
- Double Molded Case.

SPECIFICATIONS

AC Voltage
20~1000V

Frequency
50Hz~500Hz

CONTENTS



157×24×20mm
6.18"×0.94"×0.78"
42g/0.09lb



1×12V A23S
Battery



Battery



Calibration
Certificate



Quick Start
Guide

PACKAGING INFORMATION



Color Box
L82×W40×H184mm



Carton Box
39×22×35.5cm



X 40PCS



VOLTAGE TESTER

MS8922A

SKU NO.: MS8922ACBGLO
 UPC CODE: 810053674529
 EAN CODE: 8435394779591

FEATURE

- Ergonomic Design That Facilitates Its Use.
- Operation Time Maximum 30s.
- Recovery Time 10 Minutes.

SPECIFICATIONS

AC Voltage
400V

DC Voltage
400V

MAIN APPLICATIONS



DOMESTIC

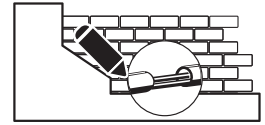

INDUSTRIAL



CONTENTS



223×40×32mm
 8.78"×1.57"×1.26"
 98.5g/0.26lb



Calibration
 Certificate



Quick Start
 Guide

PACKAGING INFORMATION



Color Box
 L125×W40×H255mm



Carton Box
 53×25×27cm



X 20PCS

CIRCUIT TESTERS

WIRE TESTERS AND TRACKER | SOCKET TESTER
CIRCUIT BREAKER FINDER

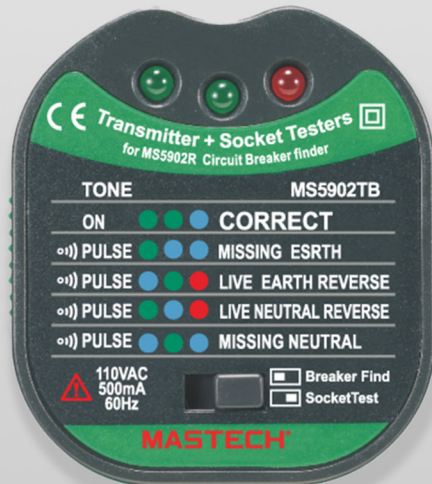



MS5902RTD



MS5902RTE



MS5902RTF

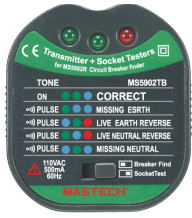

MAIN APPLICATIONS



DOMESTIC

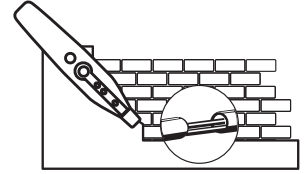
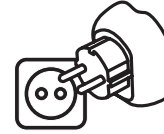

CONTENTS



MS5902R:
198x40x50mm
7.8"x1.57"x1.97"
126g/0.28lb

MS5902TD/TE:
71x64x55mm
2.8"x2.5"x2.16"
60g/0.13lb

MS5902TF:
82x42x32mm
3.2"x1.65"x1.26"
35g/0.1lb



Carry bag



Battery



1x9V 6F22
Battery



Calibration
Certificate



Quick Start
Guide

CIRCUIT BREAKER FINDER

MS5902RT

SKU NO.	MS5902RTDCBGLO	MS5902RTECBGLO	MS5902RTFCBGLO
UPC CODE	810053672877	810053675106	810053674727
EAN CODE	8435394778556	8435394783093	8435394779782

FEATURE

- Socket Tester and Circuit Breaker Finder.
- Sound and Light Signals.
- Professional Reference.

SPECIFICATIONS

AC Voltage(TD)
230V

AC Voltage(TE)
230V

AC Voltage(TF)
120V

PACKAGING INFORMATION



Color Box
L130xW63xH255mm



Carton Box
53x34x28.5cm



X 20PCS

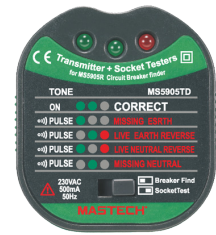

MS5905TD

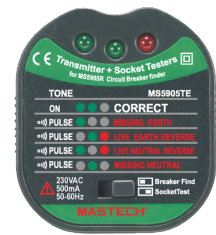

MS5905TE

MAIN APPLICATIONS

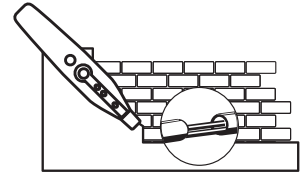
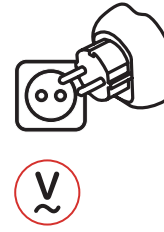

CONTENTS



MS5905R:
177×46×31mm
6.97"×1.81"×1.22"
130g/0.29lb

MS5905TD/TE:
71×64×55mm
2.8"×2.5"×2.16"
63g/0.14lb



Carry bag
Battery

ACCESSORIES



1×9V 6F22
Battery



Calibration
Certificate



Quick Start
Guide

CIRCUIT BREAKER FINDER with NCV
MS5905RT

SKU NO.	MS5905RTDCBGLO	MS5905RTECBGLO
UPC CODE	810053675120	810053673126
EAN CODE	8435394783116	8435394778853

FEATURE

- Socket Tester and Circuit Breaker Finder.
- Sound and Light Signals.
- Professional Reference.

SPECIFICATIONS

AC Voltage(TD) 230V	AC Voltage(TE) 230V
-------------------------------	-------------------------------

PACKAGING INFORMATION



Color Box
L130×W63×H255mm



Carton Box
53×34×28.5mm



X 20PCS



SOCKET TESTER

MS6861A

SKU NO.: MS6861ACBGLO
EAN CODE: 8435394788784

FEATURE

- Leakage Test Voltage Range: AC 220V±20V
- Socket Specification: CHN plug

SPECIFICATIONS

AC Voltage
175~250V / 50~60Hz

Leakage Test Current
>30mA

MAIN APPLICATIONS



DOMESTIC

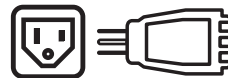

CONTENTS



87x58x63mm
3.4x2.3"x2.5"
90g/0.2lb



Calibration
Certificate



Quick Start
Guide

PACKAGING INFORMATION



Color Box
L98xW72xH78mm



Carton Box
51x31x41.5cm



X 100PCS



DISPLAY TYPE SOCKET TESTER
MS6863A

SKU NO.: MS6863ACBGLO
EAN CODE: 8435394788814

FEATURE

- Leakage Test Voltage Range: AC 220V±20V
- Socket Specification: EU plug
- LCD Panel diagram

SPECIFICATIONS

AC Voltage
175~250V / 50~60Hz

Leakage Test Current
>30mA

MAIN APPLICATIONS

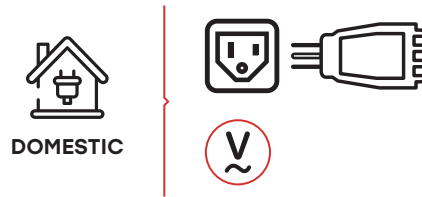

CONTENTS

- 87x58x63mm
3.4x2.3"x2.5"
90g/0.2lb
- Calibration Certificate
- Quick Start Guide

PACKAGING INFORMATION

- Color Box**
L98xW72xH78mm
- Carton Box**
51x31x41.5cm
- X 100PCS**

CIRCUIT ANALYZERS

MOTOR & PHASE ROTATION INDICATOR
CIRCUIT ANALYZER



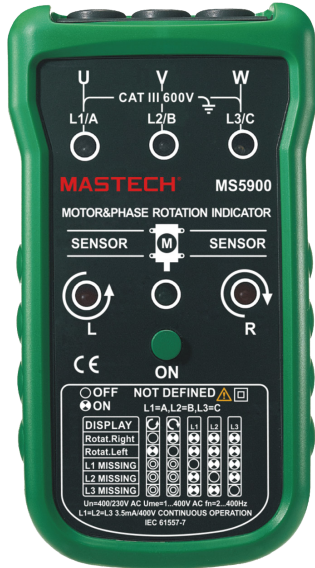

MAIN APPLICATIONS

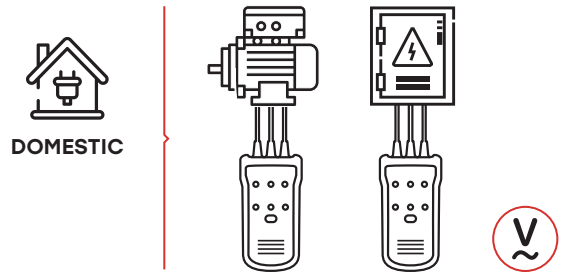

CONTENTS

- 130x72x32mm
5.1"x2.8"x1.3"
193g/0.43lb
- 1x9V 6F22 Battery
- Test alligator clips
Carry bag
Battery
- Calibration Certificate
- Quick Start Guide

MOTOR & PHASE ROTATION INDICATOR
MS5900

SKU NO.: MS5900CBGLO
UPC CODE: 810053672006
EAN CODE: 8435394777733

FEATURE

- Motor & phase rotation tester.
- Led light signals.
- Operating Altitude 2000m.
- Pollution Degree 2.

SPECIFICATIONS

AC Voltage() 120~400V	Frequency 2~400Hz
---------------------------------	-----------------------------

PACKAGING INFORMATION

- Color Box**
L168xW64xH238mm
- Carton Box**
49.5x37x35.5cm
- X 20PCS**



MAIN APPLICATIONS

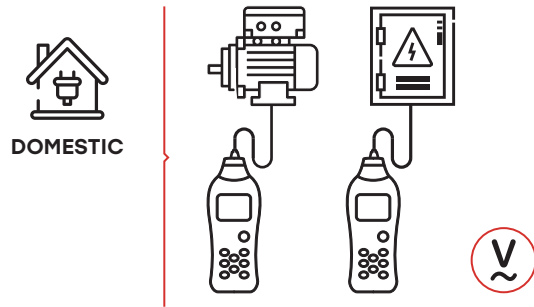

CONTENTS

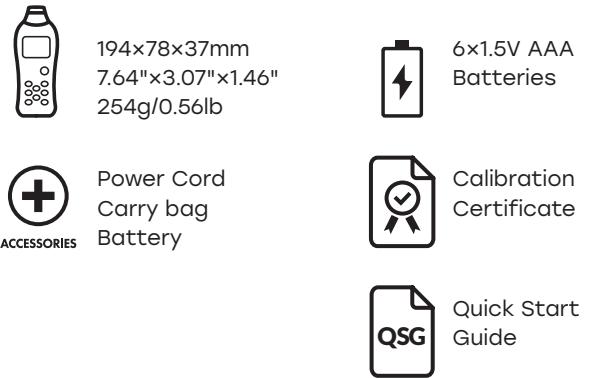

CIRCUIT ANALYZER
MS5908A

SKU NO.: MS5908ACBGLO
UPC CODE: 810053673119
EAN CODE: 8435394778846

FEATURE

- Auto Power Off.
- Data Hold.
- Low Battery Display.

SPECIFICATIONS

Line Voltage 85~135V	Peak Line Voltage 120~190V	Frequency 45~65Hz
Voltage Drop Load Current 12/15/20A	RCD Trip Time 1ms~6.5S	
RCD Trip Current 30mA~37mA	GFCI Trip Time 1ms~6.5S	GFCI Trip Current 6mA~9mA

PACKAGING INFORMATION

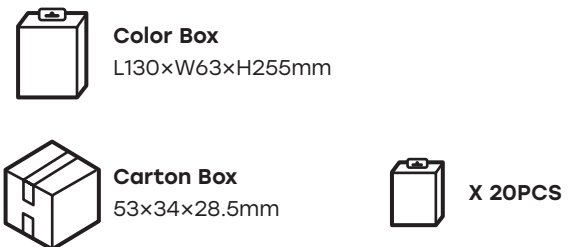





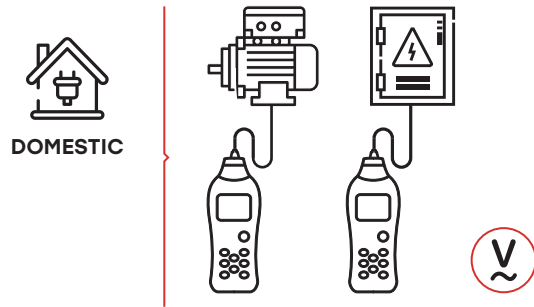

MAIN APPLICATIONS



CONTENTS

-  194x78x37mm
7.64"x3.07"x1.46"
254g/0.56lb
-  6x1.5V AAA Batteries
-  Power Cord
Carry bag
Battery
-  Calibration Certificate
-  QSG
Quick Start Guide

CIRCUIT ANALYZER

MS5908C

SKU NO.: MS5908CCBGLO
UPC CODE: 810053672808
EAN CODE: 8435394778440



FEATURE

- Auto Power Off.
- Data Hold.
- Low Battery Display.

SPECIFICATIONS

Line Voltage 85~265V	Peak Line Voltage 120~375V	Frequency 45~65Hz
Voltage Drop Load Current 5/8/10A	RCD Trip Time 1ms~6.5S	
RCD Trip Current 30mA~37mA	GFCI Trip Time 1ms~6.5S	GFCI Trip Current 6mA~9mA

PACKAGING INFORMATION

-  **Color Box**
L130xW63xH255mm
-  **Carton Box**
53x34x28.5mm
-  **X 20PCS**

WIRE & CABLE TESTERS

WIRE TRACKER TRANSMITTER | NETWORK CABLE TESTER
MULTI-FUNCTIONS CABLE TRACKER | ADVANCED CABLE LOCATOR





MAIN APPLICATIONS

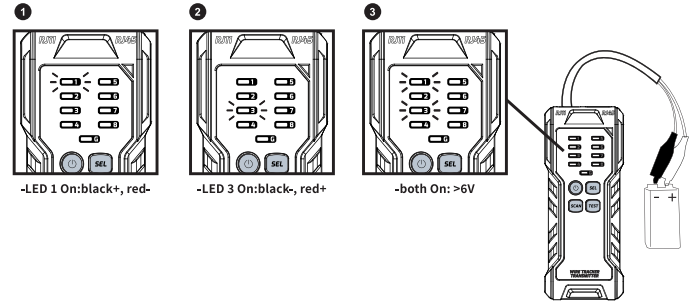

CONTENTS

- 151x100x35mm
5.9"x3.9"x1.38"
167g/0.37lb
- 9V Battery*2
- Carry bag
- Network cable
- Alligator clip
- Battery
- Calibration Certificate
- Quick Start Guide

WIRE TRACKER TRANSMITTER
MS6815B

SKU NO.: MS6815BCBGLO
EAN CODE: 8435394788586

FEATURE

- Smart Digital Line Finding
- Humanized Network Cable Sequence Alignment
- POE Switch Tracking

SPECIFICATIONS

Open & Short Circuit LED indication	Sensitivity 0~5cm
Open and Circuit Voltage Test LED indication	
Telephone Line Status LED indication	

PACKAGING INFORMATION

- Color Box**
L120xW50xH180mm
- Carton Box**
53x38x26cm
- X 40PCS**



NETWORK CABLE TESTER MS6810

SKU NO.: MS6810CBGLO
UPC CODE: 810053674345
EAN CODE: 8435394779416

FEATURE

- Widely Used For Coaxial Cable (BNC), UTP And STP Cable. It Can Automatically Check For Open Circuits, Shorts, Miswired, And Reversals.

SPECIFICATIONS

Distance
200m(max)

MAIN APPLICATIONS

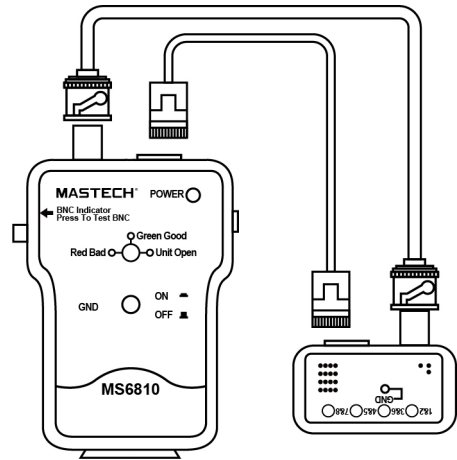

CONTENTS



153×74×31mm
6.0"×2.9"×1.2"
120g/0.26lb



1×9V 6F22
Battery



ACCESSORIES

Carry bag
Battery



Calibration
Certificate



Quick Start
Guide

PACKAGING INFORMATION



Color Box
L90×W40×H165mm



Carton Box
42.5×35×29cm



X 60PCS



NETWORK CABLE TESTER
MS6811

SKU NO.: MS6811CBGLO
UPC CODE: 810053672624
EAN CODE: 8435394778266

FEATURE

- Tests for Open Circuits, Shorts, Miswires, Reversals, and Split Pairs.
- DEBUG Quickly Identifies Which Cable Pairs Have A Specific Wiring Fault.

SPECIFICATIONS

Distance
200m(max)

MAIN APPLICATIONS

Fault details

Fig.1 SPLIT PAIRS

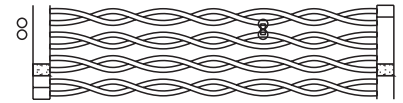

Fig.2 SHORT

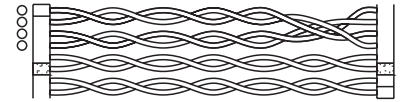

Fig.3 MISWIRE

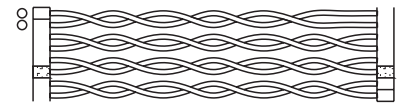
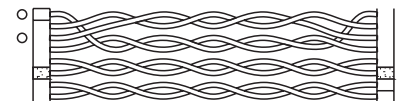

Fig.4 REVERSED



CONTENTS



125×55×30mm
4.9"×2.2"×1.2"
106g/0.23lb



1×6V 4LR44/
4AG13 Battery



Carry bag
Battery

ACCESSORIES



Calibration
Certificate



Quick Start
Guide

PACKAGING INFORMATION



Color Box
L90×W40×H165mm



Carton Box
42.5×35×29cm



X 60PCS



CABLE TRACKER
MS6812A

SKU NO.: MS6812ACBGLO
UPC CODE: 810053675274
EAN CODE: 8435394783291

FEATURE

- Sound and Light Instruction.
- Cont and Tone LED Light.

SPECIFICATIONS

Send Tone Frequency
1.5kHz

Receive Frequency
100Hz~300kHz

MAIN APPLICATIONS

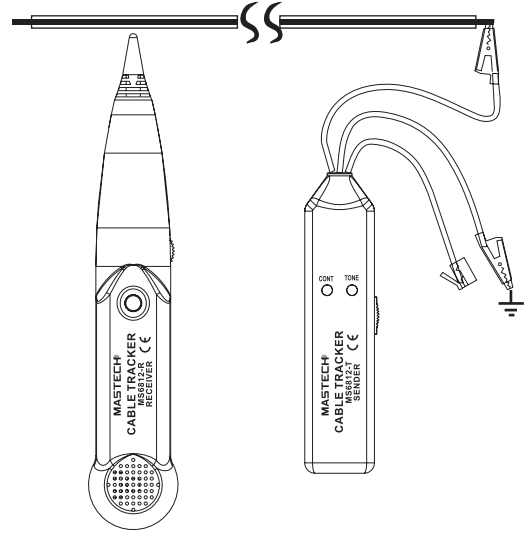

CONTENTS



Receiver:
238×43×26mm
9.4"×1.7"×1.0"
71g/0.16lb



Emitter:
145×35×25mm
5.7"×1.38"×0.98"
87g/0.2lb



ACCESSORIES

Carry bag
Battery



2x9V 6F22
Batteries



Calibration
Certificate



Quick Start
Guide

PACKAGING INFORMATION



Color Box
L125×W40×H255mm



Carton Box
53×22×27cm



X 20PCS



MULTI-FUNCTIONS CABLE TRACKER
MS6813

SKU NO.: MS6813CBGLO
UPC CODE: 810053672976
EAN CODE: 8435394778709

FEATURE

- Multifunction.
- Cable tester and tracker.
- State of the telephone lines.
- Small size ideal for transport.

SPECIFICATIONS

Receive Frequency
100Hz~300kHz

Send Tone Frequency
1.5kHz

MAIN APPLICATIONS

Fig.1 SHORT

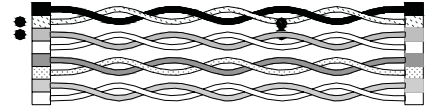

Fig.2 MISWIRE



Fig.3 REVERSED



Fig.4 SPLIT PAIRS



CONTENTS



206×84×55mm
8.1"×3.3"×2.1"
330g/0.72lb



2×9V 6F22
Batteries



ACCESSORIES

Carry bag
Battery



Calibration
Certificate



Quick Start
Guide

PACKAGING INFORMATION



Color Box
L172×W80×H255mm



Carton Box
46×27×37cm



X 10PCS



ADVANCED WIRE TRACKER **MS6818**

SKU NO.: MS6818CBGLO
UPC CODE: 810053672204
EAN CODE: 8435394777924

FEATURE

- Track Cables In The Wall or Earth.
- One or Dual-pole Application.
- Adjustable Sensitivity In Transmitter and Receiver.

SPECIFICATIONS

AC Voltage 12~400V	DC Voltage 12~400V	Output Signal 125kHz
Display Counts 2000		

MAIN APPLICATIONS

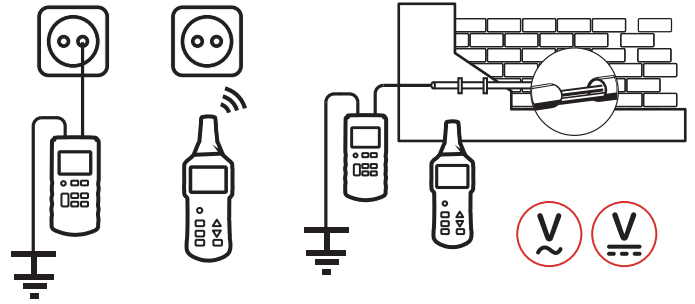

CONTENTS



Transmitter:
190×89×42.5mm
7.48"×3.5"×1.67"
420g/0.92lb



Receiver:
241.5×78×38.5mm
9.5"×3"×1.5"
350g/0.77lb



ACCESSORIES

Test leads
Test probe
Alligator clip
Grounding rod
Carry bag
Battery



1×9V 6F22 Battery/
6×1.5V AAA
Batteries



Calibration
Certificate



Quick Start
Guide

PACKAGING INFORMATION



Color Box
L200xW85xH280mm



Carton Box
44.5x32.5x42cm



X 10PCS

LCR METERS

DIGITAL LCR METER | SMART SMD TESTER







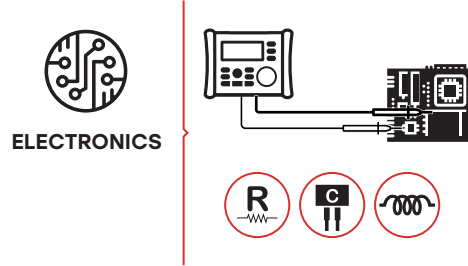

MAIN APPLICATIONS



CONTENTS

-  224x172x58mm
8.8"x6.8"x2.3"
841g/1.85lb
-  8x1.5 AA Batteries
-  **ACCESSORIES**
Kelvin test clip
SMD test probe
IR data line
Software CD
Battery
-  Calibration Certificate
-  **QSG** Quick Start Guide
- External power supply (option)

DIGITAL LCR METER WITH USB INTERFACE
MS5308

SKU NO.: MS5308CBGLO
UPC CODE: 810053673102
EAN CODE: 8435394778839



FEATURE

- Auto & Manual Ranging.
- Auto Power off.
- LCR smart check and measurement.
- DCR mode.

SPECIFICATIONS

Resistance 20~200MΩ	Capacitance 0.01pF~20mF	LCR 20mH~20kH
-------------------------------	-----------------------------------	-------------------------

PACKAGING INFORMATION

-  **Color Box**
L320xW125xH255mm
-  **Carton Box**
52x33.5x29cm
-  **X 4PCS**



DIGITAL LCR METER

MS6013

SKU NO.: MS6013CBGLO
 UPC CODE: 810053674222
 EAN CODE: 8435394779294

FEATURE

- Zero Adjustment approx. $\pm 20\text{pF}$.
- Input Jacks.
- High Accuracy in Measuring.
- Low Battery Display.

SPECIFICATIONS

Capacitance 200pF~20mF	Display Counts 2000
----------------------------------	-------------------------------

MAIN APPLICATIONS

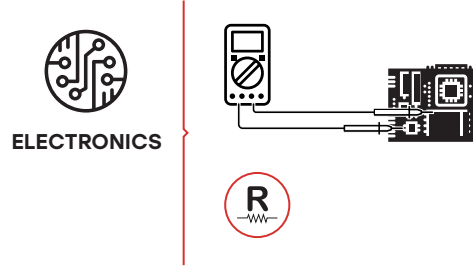

CONTENTS

- 189x91x31.5mm
7.4"x3.6"x1.2"
240g/0.52lb
- 1x9V 6F22 Battery
- Test Leads
- Carry bag
- Battery
- Calibration Certificate
- Quick Start Guide

PACKAGING INFORMATION

- Color Box**
L165xW70xH225mm
- Carton Box**
47x37.5x35.5cm
- X 20PCS**



SMART SMD TESTER (R/C)
MS8910

SKU NO.: MS8910CBGLO
UPC CODE: 810053672747
EAN CODE: 8435394778389

FEATURE

- Auto Ranging.
- Auto Power Off.
- Data Hold.
- Low Battery Display.

SPECIFICATIONS

Resistance 30MΩ	Capacitance 30mF	Display Counts 3000
Continuity 30Ω		

MAIN APPLICATIONS

ELECTRONICS

CONTENTS

175x32x20mm 6.89"x1.26"x0.79" 48g/0.10lb	1x3V CR2032 Battery
Spare test pin Battery ACCESSORIES	Calibration Certificate
	Quick Start Guide

PACKAGING INFORMATION

Color Box L57xW29xH203mm	
Carton Box 44x32x31.5cm	X 100PCS



SMART SMD TESTER (R/C/L)
MS8911

SKU NO.: MS8911CBGLO
UPC CODE: 810053674512
EAN CODE: 8435394779584

FEATURE

- Auto Ranging.
- Auto Power Off.
- Data Hold.
- Low Battery Display.

SPECIFICATIONS

Resistance 20MΩ	Capacitance 6mF	Inductance 200H
Display Counts 6000		

MAIN APPLICATIONS

ELECTRONICS

CONTENTS

186×35×23.6mm 7.3"×1.38"×0.93" 90g/0.2lb	1×3V CR2450 Battery
Spare test pin Battery ACCESSORIES	Calibration Certificate
	Quick Start Guide

PACKAGING INFORMATION





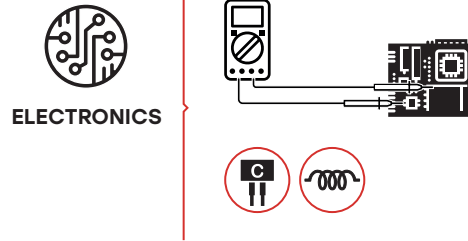

Color Box L57×W29×H203mm	
Carton Box 44×32×31.5cm	X 100PCS



MAIN APPLICATIONS



CONTENTS

-  189×91×31.5mm
7.4"×3.6"×1.2"
240g/0.52lb
-  1×9V 6F22
Battery
-  Test Leads
-  Calibration
Certificate
-  ACCESSORIES
-  QSG
Quick Start
Guide

DIGITAL LCR METER

MY6243

SKU NO.: MY6243CBGLO
UPC CODE: 810053672754
EAN CODE: 8435394778396



FEATURE

- Input Jacks.
- High Accuracy in Measuring.
- Low Battery Display.

SPECIFICATIONS

Capacitance 200µF	Inductance 2H	Display Counts 2000
-----------------------------	-------------------------	-------------------------------

PACKAGING INFORMATION

-  **Color Box**
L165×W70×H225mm
-  **Carton Box**
47×37.5×35.5cm
-  **X 20PCS**

EARTH RESISTANCE

EARTH RESISTANCE CLAMP METER | EARTH RESISTANCE TESTER
ADVANCED EARTH RESISTANCE TESTER





MAIN APPLICATIONS

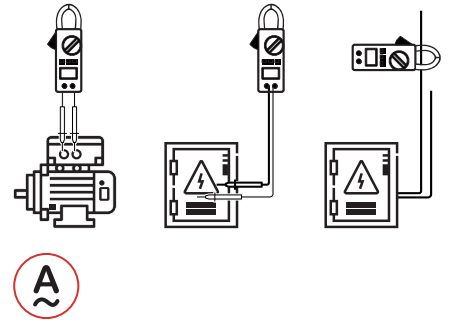
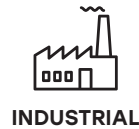
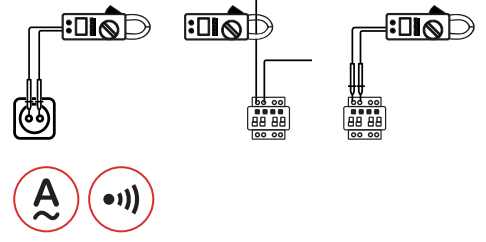

EARTH RESISTANCE CLAMP METER
MS2301

SKU NO.: MS2301CBGLO
UPC CODE: 810053674208
EAN CODE: 8435394779270

FEATURE

- Auto & Manual Ranging.
- Logging and Recall 99 Groups.
- Setting Alarm Threshold in 1~100Ω.

SPECIFICATIONS

Resistance 1200Ω	AC Current 20A	Display Counts 9999
Jaw Opening 45mmx32mm/1.8"x1.3"		Data Logging 99 groups

CONTENTS



276x104x54mm
10.8"x4.33"x2.1"
1050g/2.31lb



1x9V Alkaline Battery



ACCESSORIES

Calibration loop of resistance (1Ω/5Ω/10Ω)
Carry case
Battery



Calibration Certificate



Quick Start Guide

PACKAGING INFORMATION



Color Box
L370xW140xH324mm



Carton Box
58x39x35cm



X 4PCS



ADVANCED EARTH RESISTANCE TESTER
MS2308

SKU NO.: MS2308CTGLO
 UPC CODE: 810053676790
 EAN CODE: 8435394785318

FEATURE

- Auto Power Off.
- Alarming indicator for limit-value measurement.
- AVG.
- Compensation Resistance.

SPECIFICATIONS

3 Pole & 4 Pole Earthing-Resistance Test 0.02Ω~300kΩ		
2 Pole R (AC) 0.02Ω~300kΩ	2 Pole R (DC) 0.02Ω~3kΩ	Soil Resistivity ρ 0.02~1000

MAIN APPLICATIONS

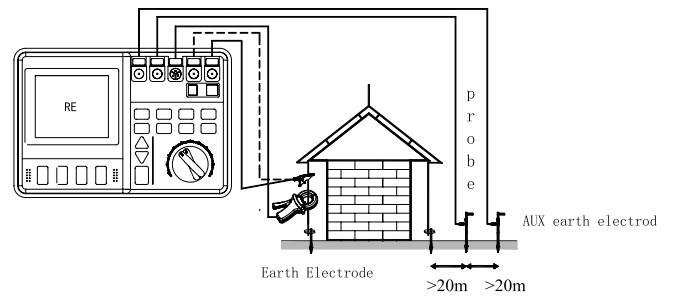
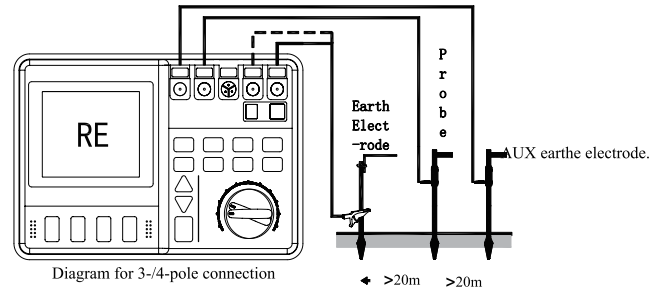

CONTENTS



284×230×125mm
 11.2"×9.1"×4.9"
 2.5kg/5.5lb



6×1.5V AA Batteries/
 Ni~MH Recharge Battery, 7.2V



ACCESSORIES

- Test wire
- Alligator clip
- Auxiliary earth bar
- Power cord
- Current transformer φ51mm
- Current clamp cable
- Carry bag
- Software CD
- USB interface cable
- Battery



Calibration Certificate



Quick Start Guide

- Rechargeable Ni-MH battery (optional)
- Charger (optional)

PACKAGING INFORMATION



Carton Box
 40×17.5×31.5cm



X 1PCS

INSULATION TESTERS

DIGITAL INSULATION TESTER | HIGH VOLTAGE DIGITAL INSULATION TESTER | ADVANCED HIGH VOLTAGE INSULATION TESTER





MAIN APPLICATIONS

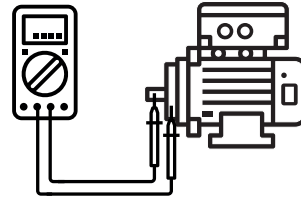

CONTENTS



192x122x55mm
7.48"x4.7"x2.2"
545g/1.3lb



6x1.5V AA
Batteries



ACCESSORIES

Test Leads
Test Clips
Screwdriver
Soft Case
Carrying Case
Battery



Calibration
Certificate



Quick Start
Guide

DIGITAL INSULATION TESTER
MS5201

SKU NO.: MS5201CBGLO
UPC CODE: 810053672884
EAN CODE: 8435394778617

FEATURE

- Data Hold.
- Low Battery Display.
- Constant Measuring Lock.

SPECIFICATIONS

AC Voltage 700V	DC Voltage 1000V	Resistance 2GΩ
Display Counts 2000	Continuity <50Ω	

PACKAGING INFORMATION



Color Box
L370xW140xH324mm



Carton Box
58x39x35cm



X 4PCS



HIGH VOLTAGE INSULATION TESTER MS5202

SKU NO.: MS5202CBGLO
 UPC CODE: 810053673072
 EAN CODE: 8435394778808

FEATURE

- Inner Battery Testing.
- Low Battery Display.
- Constant Measuring Lock.

SPECIFICATIONS

DC Output
2500V

Resistance
0~100GΩ

MAIN APPLICATIONS

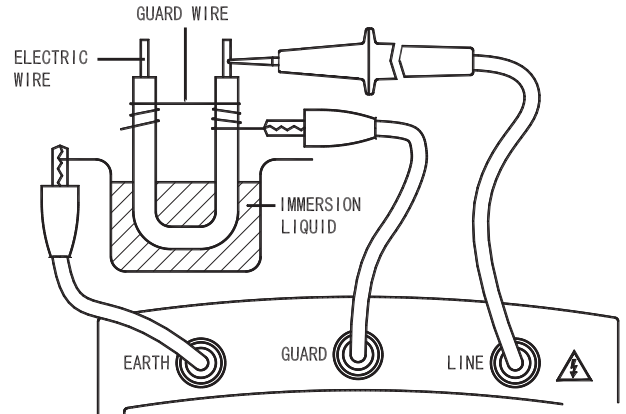

CONTENTS



225×138×81mm
 8.86"×5.3"×3.19"
 1200g/2.75lb



8×1.5V AA Batteries/
 1×9V 6F22 Battery



ACCESSORIES

Test Clips
 Carry bag
 Battery



Calibration
 Certificate



Quick Start
 Guide

PACKAGING INFORMATION



Color Box
 L370×W140×H324mm



Carton Box
 58×39×35cm



X 4PCS



**ADVANCED HIGH VOLTAGE
INSULATION TESTER
MS5215**

SKU NO.: MS5215CBGLO
UPC CODE: 810053672914
EAN CODE: 8435394778648

FEATURE

- Broad Range Of Testing Voltage.
- Insulation Diagnosis.
- Large Storage Memory.
- Clear Display.

SPECIFICATIONS

AC Voltage 50~750V	DC Voltage 50~1000V	Resistance 0.01MΩ~5TΩ
Temperature -10°C~70°C		

MAIN APPLICATIONS

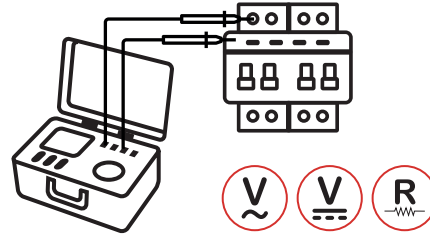

CONTENTS



284×230×125mm
11.2"×9.1"×4.9"
2426g/5.34lb



6×LR14 Batteries/
6×1.2V AA Batteries



ACCESSORIES

Tester probes leads 3m (Red/Black/Blue)
Crocodile clips (Red/Black/Blue)
Temperature Sensor
USB data line (1m)
Data analysis software CD
Instrument backpack
Battery

Charger:
Input Voltage
100V~240V

Rechargeable battery pack(for charging Ni-Hy battery)(optional)
AC charger (optional)



Calibration Certificate



Quick Start Guide

PACKAGING INFORMATION



Color Box
L400×W175×H315mm



Carton Box
42×37×34cm



X 2PCS

THERMOMETERS

DIGITAL THERMOMETER | DIGITAL THERMO-HYGROMETER
NON-CONTACT INFRARED THERMOMETER





DIGITAL THERMOMETER
MS6500

SKU NO.: MS6500CBGLO
UPC CODE: 810053673089
EAN CODE: 8435394778815

FEATURE

- Sample Rate 500mS.
- Display 2000 counts.
- Data Hold.
- K-Type Thermocouple.

SPECIFICATIONS

Celcius -50°C~750°C	Fahrenheit -58°F~1382°F	Display Counts 2000
-------------------------------	-----------------------------------	-------------------------------

MAIN APPLICATIONS

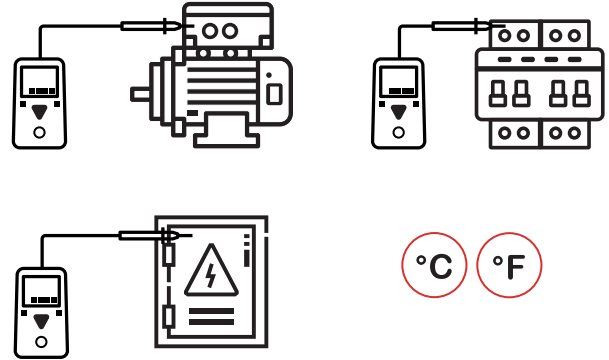

CONTENTS

- | | |
|--|----------------------------|
| 125.5x72x27mm
5.6"x2.8"x1.0"
145g/0.30lb | 1x9V 6F22
Battery |
| K type thermocouple
Carry bag
Battery | Calibration
Certificate |
| | Quick Start
Guide |

PACKAGING INFORMATION

- | | |
|-------------------------------------|----------------|
| Color Box
L105xW40xH145mm | |
| Carton Box
42x31.5x34cm | X 60PCS |



K/J THERMOMETER
MS6503

SKU NO.: MS6503CBGLO
EAN CODE: 8435394788630

FEATURE

- Type: Dual Channel
- Temperature Difference
- Screen Size: 37*41mm

SPECIFICATIONS

Temperature Measuring
-200°C~1372°C / -328°F~2501°F

Resolution
1°C / °F

ADJ
-9°C~9°C

MAIN APPLICATIONS

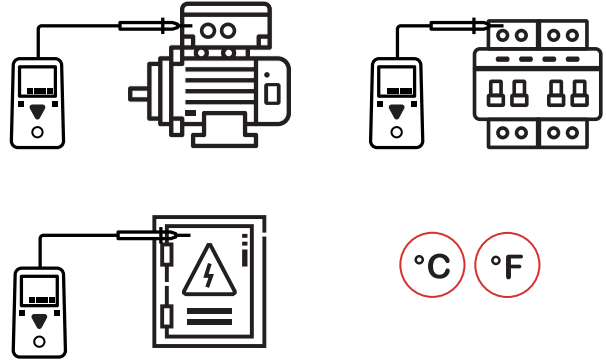

CONTENTS

- 152x55x33mm
5.9"x2.2"x1.3"
125g/0.27lb
- 1.5V AAA*3
- Carry bag
K Type Temperature probe
Battery
- Calibration Certificate
- Quick Start Guide

PACKAGING INFORMATION

- Color Box**
L89xW42xH210mm
- Carton Box**
46x37x23cm
- X 40PCS**



K/J THERMOMETER
MS6512A

SKU NO.: MS6512ACBGLO
EAN CODE: 8435394788647

FEATURE

- Type: Single Channel
- Temperature Difference
- Screen Size: 53*44mm

SPECIFICATIONS

Temperature Measuring -200°C~1372°C / -328°F~2501°F		Resolution 0.1°C/°F
ADJ -9°C~9°C	Display Counts 9999	Ambient 0°C~60°C
Bracket num 1/4inch nut		

MAIN APPLICATIONS

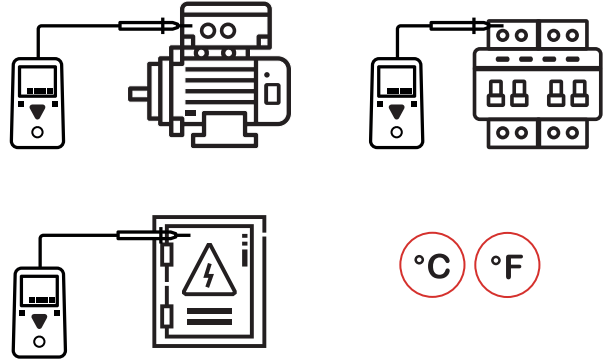

CONTENTS

- 177x70x35mm
6.9"x2.7"x1.4"
189g/0.41lb
- 1.5V AA*3 /
USB micro
interface 5V
- Carry bag
K Type Temperature
probe
Battery
- Calibration
Certificate
- Quick Start
Guide

PACKAGING INFORMATION

- Color Box**
L110xW60xH288mm
- Carton Box**
63x46.5x29.5cm
- X 40PCS**



K/J THERMOMETER
MS6512B

SKU NO.: MS6512BCBGLO
EAN CODE: 8435394788654

FEATURE

- Type: Dual Channel
- Temperature Difference
- Screen Size: 53*44mm

SPECIFICATIONS

Temperature Measuring -200°C~1372°C / -328°F~2501°F	Resolution 0.1°C/°F
ADJ -9°C~9°C	Display Counts 9999
Bracket num 1/4inch nut	Ambient 0°C~60°C

MAIN APPLICATIONS

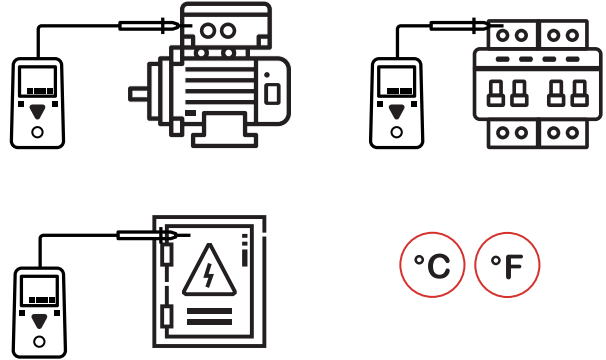

CONTENTS

- 177x70x35mm
6.9"x2.7"x1.4"
189g/0.41lb
- 1.5V AA*3 /
USB micro
interface 5V
- Carry bag
K Type Temperature
probe
Battery
- Calibration
Certificate
- Quick Start
Guide

PACKAGING INFORMATION

- Color Box**
L110xW60xH288mm
- Carton Box**
63x46.5x29.5cm
- X 40PCS**



K/J THERMOMETER
MS6512C

SKU NO.: MS6512CCBGLO
EAN CODE: 8435394788661

FEATURE

- Type: Four Channel
- Temperature Difference
- Screen Size: 53*44mm

SPECIFICATIONS

Temperature Measuring -200°C~1372°C / -328°F~2501°F		Resolution 0.1°C/°F
ADJ -9°C~9°C	Display Counts 5000	Ambient 0°C~60°C
Bracket num 1/4inch nut		

MAIN APPLICATIONS

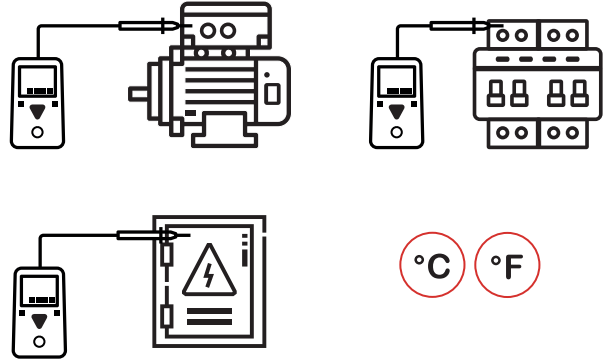

CONTENTS

- 177x70x35mm
6.9"x2.7"x1.4"
189g/0.41lb
- 1.5V AA*3 /
USB micro
interface 5V
- Carry bag
K Type Temperature
probe
Battery
- Calibration
Certificate
- Quick Start
Guide

PACKAGING INFORMATION

- Color Box**
L110xW60xH288mm
- Carton Box**
63x46.5x29.5cm
- X 40PCS**



MAIN APPLICATIONS

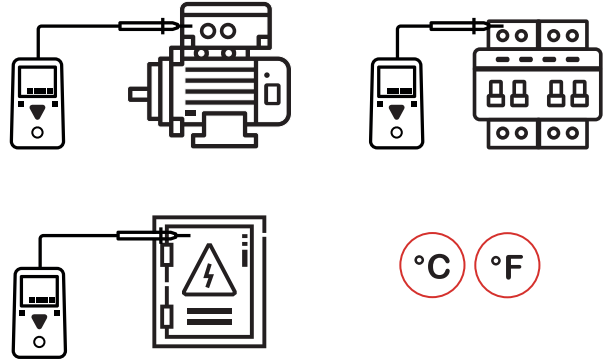

DIGITAL THERMOMETER
MS6512

SKU NO.: MS6512CBGLO
UPC CODE: 810053672945
EAN CODE: 8435394778679

FEATURE

- Auto Power Off.
- Data Hold.
- MAX/MIN/AVG.
- Low Battery Display.

SPECIFICATIONS

Type K, J, T, E	Channel T1/T2/T1-T2
---------------------------	-------------------------------

CONTENTS

	190×89×42mm 7.5"×3.5"×1.7" 350g/0.8lb		1×9V 6F22 Battery
	K type thermocouple Battery		Calibration Certificate
ACCESSORIES			Quick Start Guide

PACKAGING INFORMATION

	Color Box L165×W70×H225mm	
	Carton Box 47×37.5×35.5cm	X 20PCS



MAIN APPLICATIONS

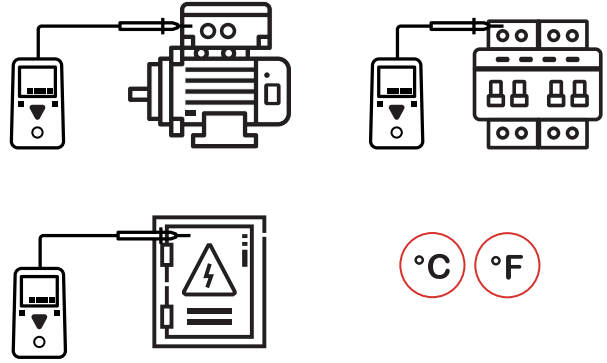

DIGITAL THERMOMETER
MS6514

SKU NO.: MS6514CBGLO
UPC CODE: 810053672037
EAN CODE: 8435394777764

FEATURE

- Auto Power Off.
- Data Hold.
- Memory Save Data.
- USB Interface.

SPECIFICATIONS

Type K, J, T, E, R, S, N	Channel T1/T2/T1-T2
------------------------------------	-------------------------------

CONTENTS

	190×89×42mm 7.5"×3.5"×1.7" 350g/0.8lb		1×9V 6F22 Battery
	K type thermocouple USB interface cable Software CD Battery		Calibration Certificate
			Quick Start Guide

PACKAGING INFORMATION

	Color Box L165×W70×H225mm	
	Carton Box 47×37.5×35.5cm	X 20PCS



INFRARED THERMOMETER
MS6522B

SKU NO.: MS6522BCBGLO
UPC CODE: 810053672617
EAN CODE: 8435394778914

FEATURE

- Spectral Response 8-14 μm .
- Laser <math><1\text{mW}</math>/630-670nm.
- Response Time 1 second.
- Relative Humidity 10%~90%

SPECIFICATIONS

Repeatability
 $\pm 0.1^{\circ}\text{C}$

Temperature
 $-20^{\circ}\text{C}\sim 500^{\circ}\text{C}/-4^{\circ}\text{F}\sim 932^{\circ}\text{F}$

Emissivity
0.95

MAIN APPLICATIONS

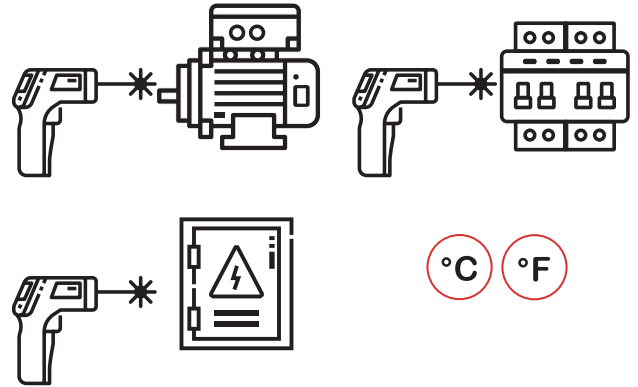

CONTENTS

 143x99x47mm
5.6"x3.9"x1.85"
135g/0.3lb

 2x1.5V AAA
Batteries

 Battery
ACCESSORIES

 Calibration
Certificate

 QSG
Quick Start
Guide

PACKAGING INFORMATION

 **Color Box**
L125xW55xH183mm

 **Carton Box**
57.5x39.1x27.5cm

 **X 40PCS**



INFRARED THERMOMETER
MS6525A

SKU NO.: MS6525ACBGLO
EAN CODE: 8435394788821

FEATURE

- °C / °F Conversion
- Backlight
- VA Color Screen
- Screen Size: 41*39mm

SPECIFICATIONS

Temperature Measuring
-32°C~1100°C / -26°F~2012°F

Repeatability
±1°C (2°F)

Emissivity
0.1~1.00

MAIN APPLICATIONS

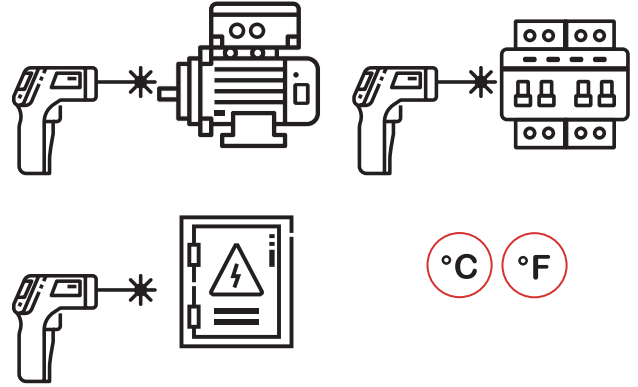

CONTENTS

- 213x140x60mm
8.4"x5.5"x2.4"
360g/0.79lb
- 9V 6F22 Battery
- Carry bag
Battery
- Calibration Certificate
- Quick Start Guide

PACKAGING INFORMATION

- Color Box**
L221xW90xH286mm
- Carton Box**
59x47x24cm
- X 10PCS**



INFRARED THERMOMETER
MS6525B

SKU NO.: MS6525BCBGLO
EAN CODE: 8435394788838

FEATURE

- °C / °F Conversion
- Backlight
- VA Color Screen
- Screen Size: 41*39mm

SPECIFICATIONS

Temperature Measuring
-32°C~1400°C / -26°F~2552°F

Repeatability
±1°C (2°F)

Emissivity
0.1~1.00

MAIN APPLICATIONS

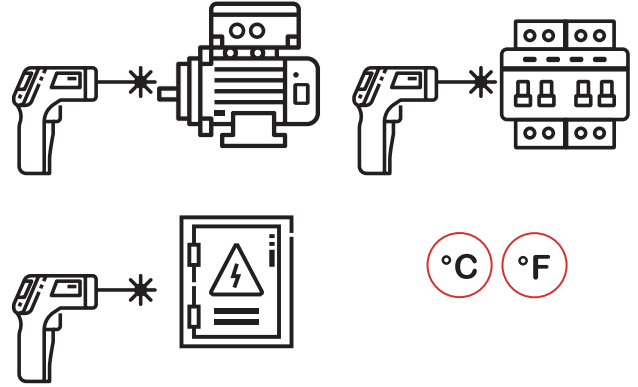

CONTENTS

- 213x140x60mm
8.4"x5.5"x2.4"
360g/0.79lb
- 9V 6F22 Battery
- Carry bag
- Battery
- Calibration Certificate
- Quick Start Guide

PACKAGING INFORMATION

- Color Box**
L221xW90xH286mm
- Carton Box**
59x47x24cm
- X 10PCS**



MAIN APPLICATIONS

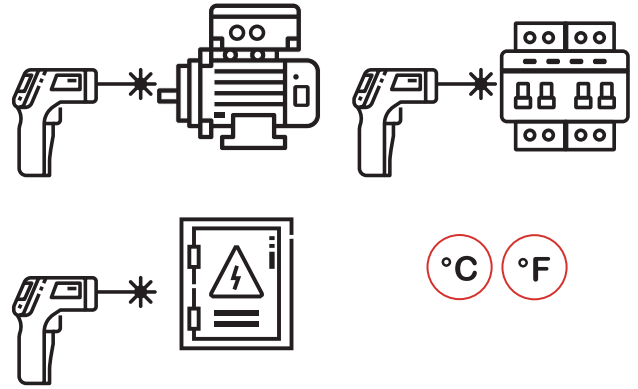

INFRARED THERMOMETER COLOR LCD
MS6531B

SKU NO.: MS6531BCBGLO
UPC CODE: 810053672969
EAN CODE: 8435394778693

FEATURE

- Color Display.
- Auto Power Off.
- Spectral Response 8-14 μm.
- Laser <1mW/630-670nm.

SPECIFICATIONS

IRT Temperature -40°C~800°C/-40°F~1472°F	Repeatability ±0.1°C
Emissivity 0.10~0.99	

CONTENTS

- 176×132×49mm
6.9"×5.2"×1.9"
223g/0.5lb
- 1×9V 6F22 Battery
- Carry bag
Battery
- Calibration Certificate
- Quick Start Guide

PACKAGING INFORMATION

- Color Box**
L126×W58×H210mm
- Carton Box**
44.5×34×28cm
- X 20PCS**



MAIN APPLICATIONS

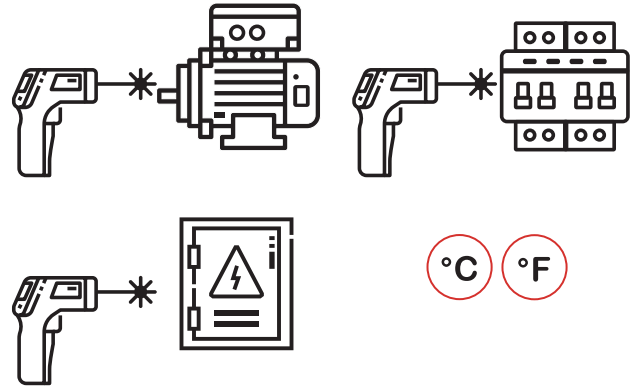

INFRARED THERMOMETER COLOR LCD
MS6531C

SKU NO.: MS6531CCBGLO
UPC CODE: 810053674284
EAN CODE: 8435394779355

FEATURE

- Color Display.
- Auto Power Off.
- Spectral Response 8-14 μm.
- Laser <1mW/630-670nm.

SPECIFICATIONS

IRT Temperature -40°C~800°C/-40°F~1472°F	Repeatability ±0.1°C
K-Type Temperature -40°C~1080°C/-40°F~1976°F	Emissivity 0.10~0.99

CONTENTS

- 176x132x49mm
6.9"x5.2"x1.9"
223g/0.5lb
- 1x9V 6F22 Battery
- K type thermocouple
Carry bag
Battery
- Calibration Certificate
- Quick Start Guide

PACKAGING INFORMATION

- Color Box**
L126xW58xH210mm
- Carton Box**
44.5x34x28cm
- X 20PCS**

ENVIRONMENTAL METERS

THERMO-HYGROMETERS | MOISTURE METERS | SOUND METERS
ANEMOMETERS | LIGHT METERS | GAS DETECTOR
ENVIRONMENT TESTER





MINI THERMO-HYGROMETER
MS6509

SKU NO.: MS6509CBGLO
EAN CODE: 8435394788456

FEATURE

- Temperature Measurement
- Humidity Measurement
- °C / °F Selection
- MAX / MIN

SPECIFICATIONS

Temperature Measuring
0°C~60°C / 32°F~140°F

Humidity
0%~100%RH

Display Counts
9999

MAIN APPLICATIONS

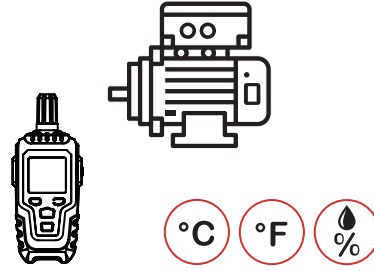

CONTENTS



154x59x30mm
6.0"x2.3"x1.2"
106g/0.23lb



1.5V AAA*3



Battery

ACCESSORIES



Calibration Certificate



Quick Start Guide

PACKAGING INFORMATION



Color Box
L154xW59xH190mm



Carton Box
45.5x41x23cm



X 40PCS



MOISTURE TESTER

MS6900

SKU NO.: MS6900CBGLO
 UPC CODE: 810053674376
 EAN CODE: 8435394779447

FEATURE

- Verification Test Points.
- Depth 0~50mm.
- Sampling Rate 240ms.
- Unit Selection %, WB, TD, °C, °F, %RH.

SPECIFICATIONS

Material Moisture 0.0~60.0%	Ambient TEMP -10°C~50°C/14°F~122°F
Relative Humidity 10~90%	

MAIN APPLICATIONS

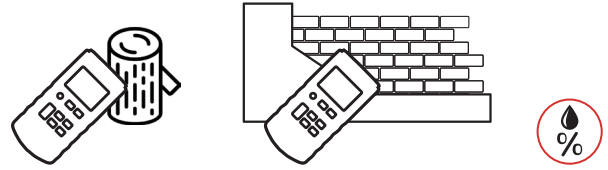

CONTENTS

	130×56×29mm 5.1"×2.2"×1.1" 120g/0.26lb		2×1.5V AAA Batteries
	Carry bag Battery		Calibration Certificate
	ACCESSORIES		Quick Start Guide

PACKAGING INFORMATION

	Color Box L75×W55×H155mm	
	Carton Box 61×33×25cm	X 60PCS



MAIN APPLICATIONS

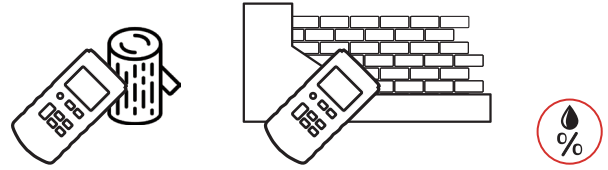

CONTENTS



130×56×29mm
5.1"×2.2"×1.1"
120g/0.26lb



2×1.5V AAA
Batteries



Carry bag
Battery



Calibration
Certificate

ACCESSORIES



Quick Start
Guide

PACKAGING INFORMATION



Color Box
L75×W55×H155mm



Carton Box
61×33×25cm



X 60PCS

MOISTURE TESTER

MS6900A

SKU NO.: MS6900ACBGLO
UPC CODE: 810053675298
EAN CODE: 8435394783314

FEATURE

- Verification Test Points.
- Depth 0~50mm.
- Sampling Rate 240ms.
- Unit Selection %, WB, TD, °C, °F, %RH.

SPECIFICATIONS

Material Moisture
0.0~60.0%

Ambient TEMP
-10°C~50°C/14°F~122°F

Relative Humidity
10~90%



MOISTURE METER
MS6901

SKU NO.: MS6901CBGLO
EAN CODE: 8435394788739

FEATURE

- Screen Size: 37*41mm

SPECIFICATIONS

Measuring Range 0~54.8%RH	Resolution 0.1%RH	Humidity 0%~100%RH
Display Counts 1999		

MAIN APPLICATIONS

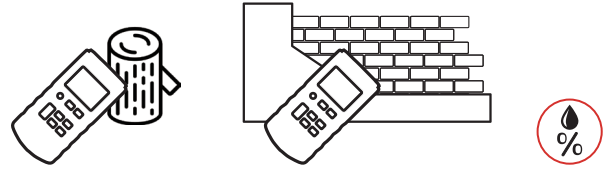

CONTENTS

	145x55x33mm 5.7"x2.2"x1.3" 115g/0.25lb		1.5V AAA*3
	Carry bag		Calibration Certificate
	Battery		Quick Start Guide

PACKAGING INFORMATION

	Color Box L89xW42xH210mm	
	Carton Box 46x37x23cm	X 40PCS



DIGITAL SOUND LEVEL METER

MS6701

SKU NO.: MS6701CBGLO
 UPC CODE: 810053674321
 EAN CODE: 8435394779393

FEATURE

- Auto & Manual Ranging.
- Auto Power Off.
- Dynamic 50dB.
- Frequency 31.5Hz~8kHz.

SPECIFICATIONS

Sound Level
30dB~130dB

Frequency
31.5Hz~8KHz

Dynamic
50dB

Data Recording
16000

Display Counts
2000

MAIN APPLICATIONS

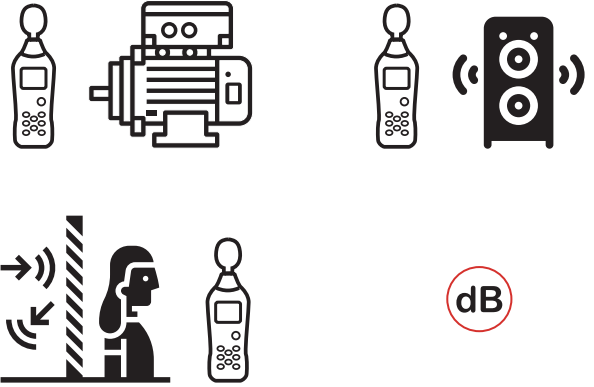

CONTENTS



265×80×69mm
 10.4"×3.15"×2.7"
 317g/0.7lb



6×1.5V AAA
 Batteries



ACCESSORIES

Windscreen
 Earphone plug
 Wapping case
 USB Interface cable
 Software CD
 Battery



Calibration
 Certificate



Quick Start
 Guide

PACKAGING INFORMATION



Color Box
 L160×W74×H295mm



Carton Box
 38.5×32×34cm



X 10PCS



MINI SOUND LEVEL METER
MS6702A

SKU NO.: MS6702ACBGLO
EAN CODE: 8435394788463

FEATURE

- Loudness Measurement
- Temperature Measurement
- MAX / MIN
- Data Hold / Backlight

SPECIFICATIONS

Level Range 35~135dB	Resolution 0.1dB	Frequency 31.5Hz~8KHz
Dynamic Range 50dB		

MAIN APPLICATIONS

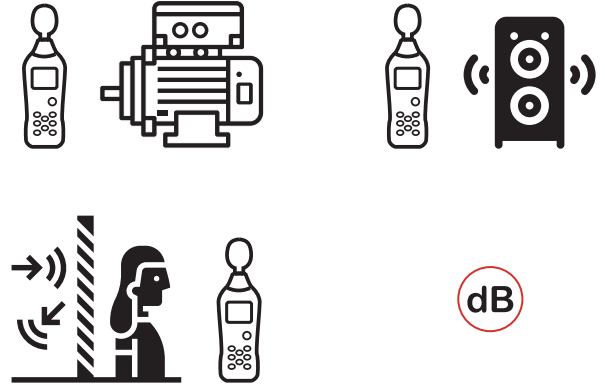

CONTENTS

154x59x30mm 6.0"x2.3"x1.2" 108g/0.24lb	1.5V AAA*3
Battery	Calibration Certificate
ACCESSORIES	Quick Start Guide

PACKAGING INFORMATION

Color Box L102xW40xH190mm	
Carton Box 45.5x41x30cm	X 40PCS



DIGITAL SOUND LEVEL METER
MS6703A

SKU NO.: MS6703ACBGLO
EAN CODE: 8435394788715

FEATURE

- Data Hold / Auto Power Off
- A / C Weighting
- USB micro interface 5V
- Screen Size: 53*44mm

SPECIFICATIONS

Measuring Range 30~130dB	Accuracy ±1.5dB	Response 31.5Hz~8KHz
Measuring Level 30~70dB, 60~90dB, 80~110dB, 100~130dB		

MAIN APPLICATIONS

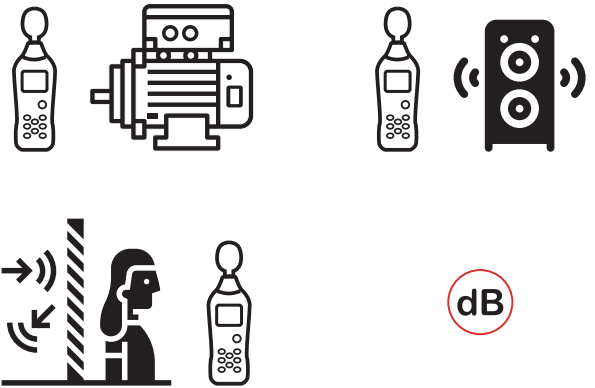

CONTENTS

- 229x70x35mm
9.0"x2.76"x1.38"
215g/0.47lb
- 1.5V AA*3 /
USB micro
interface 5V
- Carry bag
USB Cable
Battery
- Calibration
Certificate
- Quick Start
Guide

PACKAGING INFORMATION

- Color Box**
L110xW60xH288mm
- Carton Box**
63x46.5x29.5cm
- X 40PCS**



DIGITAL SOUND LEVEL METER
MS6703B

SKU NO.: MS6703BCBGLO
EAN CODE: 8435394788722

FEATURE

- Data Hold / Auto Power Off
- A / C / Z Weighting
- USB micro interface 5V
- Screen Size: 53*44mm

SPECIFICATIONS

Measuring Range 30~130dB	Accuracy ±1.5dB	Response 31.5Hz~8KHz
Measuring Level 30~70dB, 60~90dB, 80~110dB, 100~130dB		

MAIN APPLICATIONS

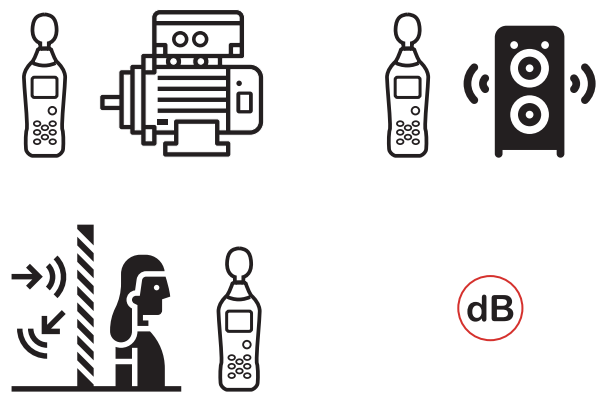

CONTENTS

- 229x70x35mm
9.0"x2.76"x1.38"
215g/0.47lb
- 1.5V AA*3 /
USB micro
interface 5V
- Carry bag
USB Cable
Battery
- Calibration
Certificate
- Quick Start
Guide

PACKAGING INFORMATION

- Color Box**
L110xW60xH288mm
- Carton Box**
63x46.5x29.5cm
- X 40PCS**



DIGITAL SOUND LEVEL METER
MS6708

SKU NO.: MS6708CBGLO
UPC CODE: 810053674338
EAN CODE: 8435394779409

FEATURE

- Auto & Manual Ranging.
- Auto Power Off.
- Dynamic 50dB.
- Loudness Measurement..

SPECIFICATIONS

Sound Level 30dB~130dB	Frequency 30Hz~8kHz	Dynamic 50dB
Display Counts 2000		

MAIN APPLICATIONS

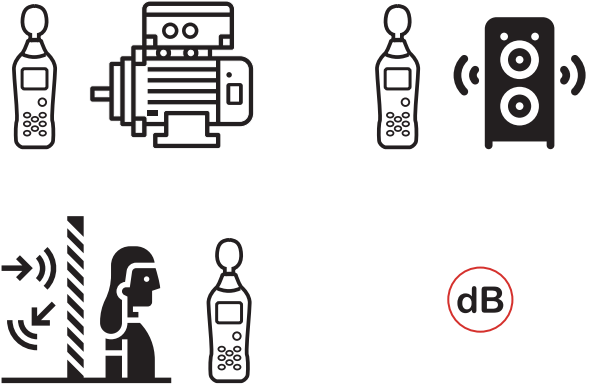

CONTENTS

193x60x29mm 7.6"x2.4"x1.1" 222g/0.48lb	4x1.5V AAA Batteries
Windscreen Carry bag Battery	Calibration Certificate
	Quick Start Guide

PACKAGING INFORMATION

Color Box L95xW45xH230mm	
Carton Box 49.5x27x41cm	X 40PCS



DIGITAL ANEMOMETER
MS6252A

SKU NO.: MS6252ACBGLO
UPC CODE: 810053672181
EAN CODE: 8435394777900

FEATURE

- Display 9999 Counts With Backlight.
- Flow Area Setting.
- MAX/MIN.
- Data Hold.

SPECIFICATIONS

m/s 0.80~40.00m/s	km/h 2.88~144.0km/h	ft/s 2.62~131.2ft/s
Knots 1.6~77.70knots	mile/h 1.8~90.00mil/h	ft/m 157.5~7874ft/m
Display Counts 9999		

MAIN APPLICATIONS

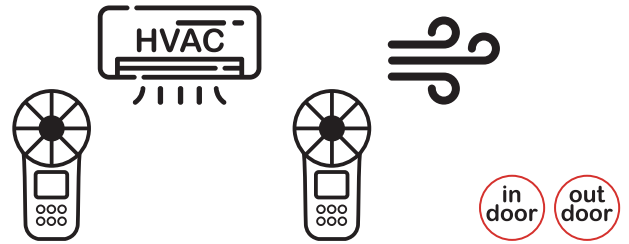

CONTENTS

	165×85×38mm 6.5"×3.3"×1.5" 168g/0.37lb		1×9V 6F22 Battery
	Carry bag Battery		Calibration Certificate
	Detector bracket (optional)		Quick Start Guide

PACKAGING INFORMATION

	Color Box L110×W60×H190mm	
	Carton Box 40×33.5×24cm	X 20PCS



DIGITAL ANEMOMETER
MS6252B

SKU NO.: MS6252BCBGLO
UPC CODE: 810053673096
EAN CODE: 8435394778822

FEATURE

- USB Interface.
- Display 9999 Counts With Backlight.
- Temperature Mode.
- MAX/MIN/Data Hold.

SPECIFICATIONS

m/s 0.80~40.00m/s	km/h 2.88~144.0km/h	ft/s 2.62~131.2ft/s
Knots 1.6~77.7knots	mile/h 1.8~90.00mil/h	ft/m 157.5~7874ft/m
Temperature -10°C~60°C/14°F~140°F		Display Counts 9999

MAIN APPLICATIONS

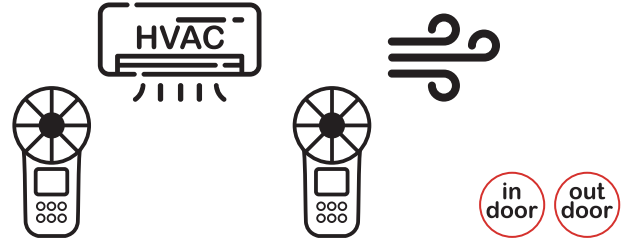

CONTENTS

	165×85×38mm 6.5"×3.3"×1.5" 168g/0.37lb		1×9V 6F22 Battery
	Carry bag Battery USB interface cable Software CD		Calibration Certificate
	Detector bracket (optional)		Quick Start Guide

PACKAGING INFORMATION

	Color Box L110×W60×H190mm	
	Carton Box 40×33.5×24cm	X 20PCS



DIGITAL ANEMOMETER

MS6253A

SKU NO.: MS6253ACBGLO
EAN CODE: 8435394788692

FEATURE

- Measurement Method: Integral Type
- Seneor: Infrared Laser Tube Cutting Method
- USB micro interface 5V

SPECIFICATIONS

Air Velocity 0.06~45.0m/S	Air Velocity 1.0~162.0Km/h	Air Velocity 10~8858ft/m
Air Velocity 1.0~147.6ft/s	Air Velocity 1.0~100.6mile/h	Air Velocity 0.1~84.48Knots
Display Counts 1000	Air Volume Measurement CMM / CFM / CMS / 0~9999m³	

MAIN APPLICATIONS

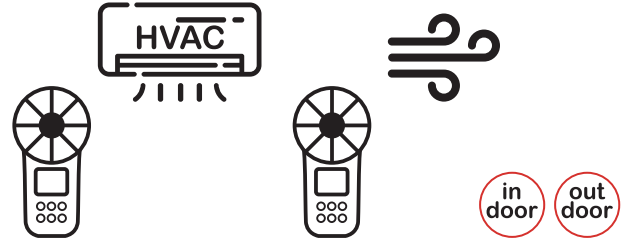

CONTENTS

- 239x73x35mm
9.1"x2.9"x1.4"
210g/0.46lb
- 1.5V AAA*3 /
USB micro
interface 5V
- Carry bag
USB Cable
Battery
- Calibration
Certificate
- Quick Start
Guide

PACKAGING INFORMATION

- Color Box**
L110xW60xH288mm
- Carton Box**
63x46.5x29.5cm
- X 40PCS**



DIGITAL ANEMOMETER
MS6253B

SKU NO.: MS6253BCBGLO
EAN CODE: 8435394788708

FEATURE

- Measurement Method: Integral Type
- Seneor: Infrared Laser Tube Cutting Method
- USB micro interface 5V
- USB Connection

SPECIFICATIONS

Air Velocity 0.06~45.0m/S	Air Velocity 1.0~162.0Km/h	Air Velocity 10~885ft/m
Air Velocity 1.0~147.6ft/s	Air Velocity 1.0~100.6mile/h	Air Velocity 0.1~84.48Knots
Display Counts 1000	Air Volume Measurement CMM / CFM / CMS / 0~9999m³	

MAIN APPLICATIONS

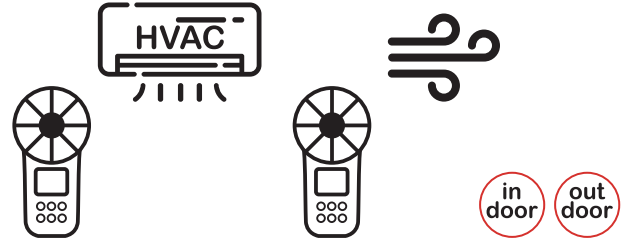

CONTENTS

- 239x73x35mm
9.1"x2.9"x1.4"
210g/0.46lb
- 1.5V AA*3 /
USB micro
interface 5V
- Carry bag
USB Cable
Battery
- Calibration
Certificate
- Quick Start
Guide

PACKAGING INFORMATION

- Color Box**
L110xW60xH288mm
- Carton Box**
63x46.5x29.5cm
- X 40PCS**



MINI ANEMOMETER

MS6652C

SKU NO.: MS6652CCBGLO
EAN CODE: 8435394788449

FEATURE

- Air Velocity Measurement
- Air Velocity Grade
- Temperature Measurement
- Air Volume Measurement

SPECIFICATIONS

Air Velocity 0.4~30.0m/S	Air Velocity 1.4~108km/h	Air Velocity 0.9~67.0mph
Air Velocity 0.8~58.0knots	Air Velocity 80~5900ft/min	Display Counts 9999
Air Volume Measurement CMM / CFM / 0~9999		Accuracy 0.1°C/ 0.1°F

MAIN APPLICATIONS

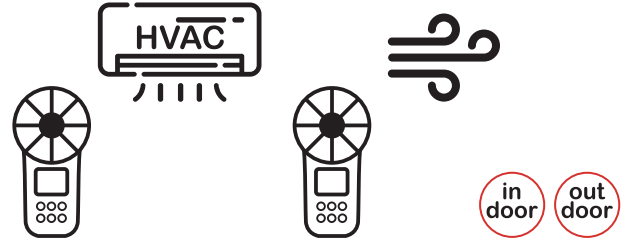

CONTENTS

- 154x59x30mm
6.0"x2.3"x1.2"
108g/0.24lb
- 1.5V AAA*3
- Battery
- Calibration Certificate
- Quick Start Guide

PACKAGING INFORMATION

- Color Box**
L102xW40xH190mm
- Carton Box**
45.5x41x30cm
- X 40PCS**



DIGITAL LIGHTMETER [LUX]
MS6610

SKU NO.: MS6610CBGLO
UPC CODE: 810053673058
EAN CODE: 8435394778785

FEATURE

- Data Hold.
- Silicon Photo Diode with Filter Photo Detector.
- Lead Length 150cm (Approx).
- Low Battery Indicator.

SPECIFICATIONS

LUX Ranging 50,000	Display Counts 2000
------------------------------	-------------------------------

MAIN APPLICATIONS

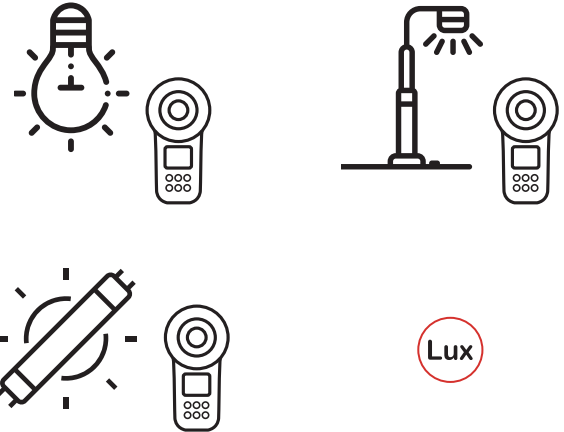

CONTENTS

	126×72×27mm 5.0"×2.8"×1.0" 180g/0.4lb	Detector Size: 83×52×21mm 3.2"×2.0"×0.8"
	Carry bag Battery	1×9V 6F22 Battery
	Calibration Certificate	
		Quick Start Guide

PACKAGING INFORMATION

	Color Box L115×W55×H165mm	
	Carton Box 48×34×31.5cm	X 40PCS



DIGITAL LIGHTMETER [LUX/FC]
MS6612

SKU NO.: MS6612CBGLO
UPC CODE: 810053674307
EAN CODE: 8435394779379

FEATURE

- Relative Measurement.
- Peak Measurement.
- Zero Calibration.
- LUX & FC unit selection.

SPECIFICATIONS

LUX Ranging 200,000	FC Ranging 20,000	Display Counts 2000
-------------------------------	-----------------------------	-------------------------------

MAIN APPLICATIONS

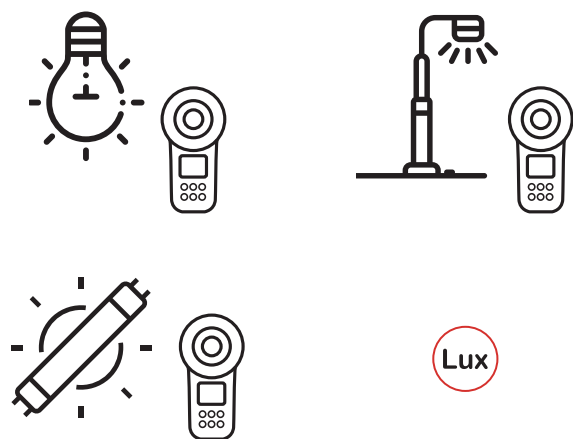

CONTENTS

	170×89×43mm 6.7"×3.5"×1.7" 420g/0.93lb		1×9V 6F22 Battery
	Carry bag Battery		Calibration Certificate
ACCESSORIES			Quick Start Guide

PACKAGING INFORMATION

	Color Box L110×W60×H190mm	
	Carton Box 40×33.5×24cm	X 20PCS



MINI LUX METER
MS6612A

SKU NO.: MS6612ACBGLO
EAN CODE: 8435394788470

FEATURE

- LUX Measurement
- Temperature Measurement
- LCD
- Unit Selection

SPECIFICATIONS

Measuring Range(LUX) 0LUX~200KLUX	Resolution 1LUX / 1FC
Measuring Range(FC) 0FC~20KFC	Display Counts 9999
Temperature Range 0°C~60°C/ 32°F~140°F	

MAIN APPLICATIONS

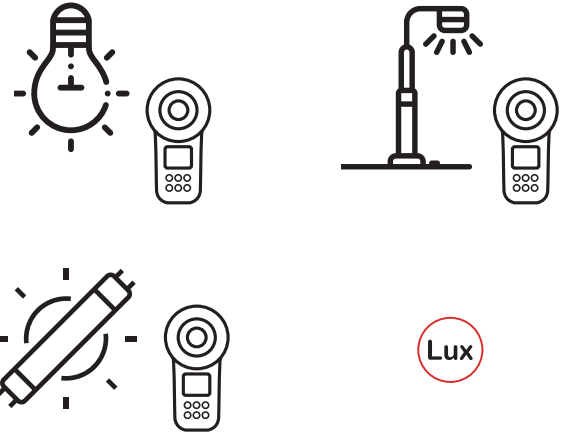

CONTENTS

- 154x59x30mm
6.0"x2.3"x1.2"
116g/0.25lb
- 1.5V AAA*3
- Battery
- Calibration Certificate
- Quick Start Guide

PACKAGING INFORMATION

- Color Box**
L102xW40xH190mm
- Carton Box**
45.5x41x30cm
- X 40PCS**



DIGITAL LIGHT METER
MS6613A

SKU NO.: MS6613ACBGLO
EAN CODE: 8435394788678

FEATURE

- Digital Light Probes and Filters
- Auto Power Off
- Screen Size: 53*44mm

SPECIFICATIONS

Measuring Range 0.1~200000LUX	Resolution 1LUX / 1FC
Measuring Level 19999*10 LUX / 19999 FC	Ambient 0°C~60°C
Spectral Range 400~700nm	Display Counts 9999

MAIN APPLICATIONS



CONTENTS

256x67x35mm 10.0"x2.6"x1.4" 250g/0.55lb	1.5V AA*3
Carry bag Battery	Calibration Certificate
ACCESSORIES	Quick Start Guide

PACKAGING INFORMATION

Color Box L110xW60xH288mm	
Carton Box 63x46.5x29.5cm	X 40PCS



DIGITAL LIGHT METER
MS6613B

SKU NO.: MS6613BCBGLO
EAN CODE: 8435394788685

FEATURE

- USB Connection
- Digital Light Probes and Filters
- Auto Power Off
- Screen Size: 53*44mm

SPECIFICATIONS

Measuring Range 0.1~200000LUX	Resolution 1LUX / 1FC
Measuring Level 19999*10 LUX / 19999 FC	Ambient 0°C~60°C
Spectral Range 400~700nm	Display Counts 9999

MAIN APPLICATIONS

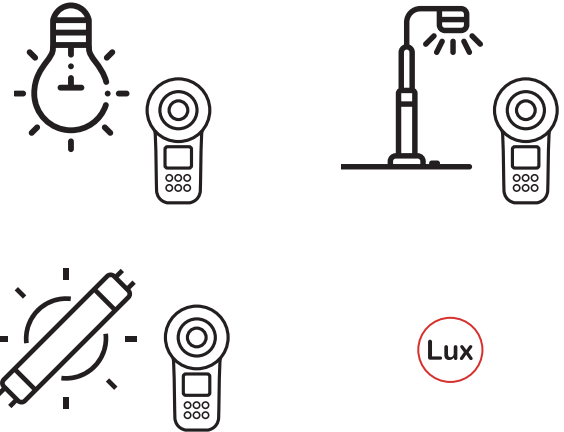

CONTENTS

	256x67x35mm 10.0"x2.6"x1.4" 250g/0.55lb		1.5V AA*3
	Carry bag Battery		Calibration Certificate
ACCESSORIES			Quick Start Guide

PACKAGING INFORMATION

	Color Box L110xW60xH288mm	
	Carton Box 63x46.5x29.5cm	X 40PCS



COMBUSTIBLE GAS DETECTOR
MS6310

SKU NO.: MS6310CBGLO
UPC CODE: 810053672334
EAN CODE: 8435394778242

FEATURE

- Easy to Identify and Pinpoint Gas Leaks.
- Portable and High Sensitivity.
- Resume Original Measurement State After 7~10 Minutes in Clear Air.

SPECIFICATIONS

Resolution
50ppm

Alarm
10%~40%

MAIN APPLICATIONS



CONTENTS



172×70×465mm
6.8"×2.8"×1.8"
354g/0.78lb



4×1.5 AA
Batteries



Carry bag
Battery



Calibration
Certificate

ACCESSORIES



Quick Start
Guide

PACKAGING INFORMATION



Color Box
L130×W63×H255mm



Carton Box
53×34×28.5mm



X 20PCS



GAS LEAK DETECTOR

MS6311A

SKU NO.: MS6311ACBGLO
EAN CODE: 8435394788746

FEATURE

- Screen Size: 53*44mm
- USB micro interface
- Display Mode: Analog Bar
- Alarm Mode: Display, Sound & Light alarm

SPECIFICATIONS

Sensitivity 50PPM(CH4)	Range %LEL:0~20%, PPM:0~9999PPM
Resolution (%LEL) 0~20%(0.1)	Resolution (PPM) 0~999PPM(0.1), 1000~9999PPM(1)

MAIN APPLICATIONS



CONTENTS

- 192x70x35mm
7.6"x2.76"x1.38"
275g/0.61lb
- 3.7V / 1000mAh
Li Battery /
USB micro interface
(DC 5V / 1A)
- Carry bag
USB Cable
Battery
- Calibration
Certificate
- Quick Start
Guide

PACKAGING INFORMATION

- Color Box**
L146xW42xH252mm
- Carton Box**
52.5x42x25.2cm
- X 40PCS**



GAS LEAK DETECTOR
MS6311B

SKU NO.: MS6311BCBGLO
EAN CODE: 8435394788753

FEATURE

- Screen Size: 53*44mm
- USB micro interface
- Display Mode: Analog Bar
- Alarm Mode: Display, Sound & Light alarm

SPECIFICATIONS

Sensitivity 50PPM(CH4)	Range %LEL:0~20%, PPM:0~9999PPM
Resolution (%LEL) 0~20%(0.1)	Resolution (PPM) 0~999PPM(0.1), 1000~9999PPM(1)
Ambient Temp. 0~60°C	

MAIN APPLICATIONS

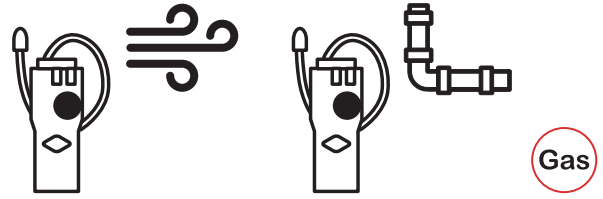

CONTENTS

- 192x70x35mm
7.6"x2.76"x1.38"
275g/0.61lb
- 3.7V / 1000mAh
Li Battery /
USB micro interface
(DC 5V / 1A)
- Carry bag
USB Cable
Battery
- Calibration
Certificate
- Quick Start
Guide

PACKAGING INFORMATION

- Color Box**
L146xW42xH252mm
- Carton Box**
52.5x42x25.2cm
- X 40PCS**



MULTI-FUNCTIONS ENVIRONMENT TESTER
MS6300

SKU NO.: MS6300CBGLO
UPC CODE: 810053672594
EAN CODE: 8435394778235

FEATURE

- AVG / MAX / MIN / DIF (MAX-MIN)
- A/C Weighting Indication.
- Data Hold.
- Display Backlight.

SPECIFICATIONS

Sound Level 30~130dB(A)	Luminance 0~50,000LUX	Wind Speed 0.5~20m/s
Air Flow 999,900CMM/CFM		Humidity 20~80%RH
Temperature -10°C~60°C/14°F~140°F		

MAIN APPLICATIONS

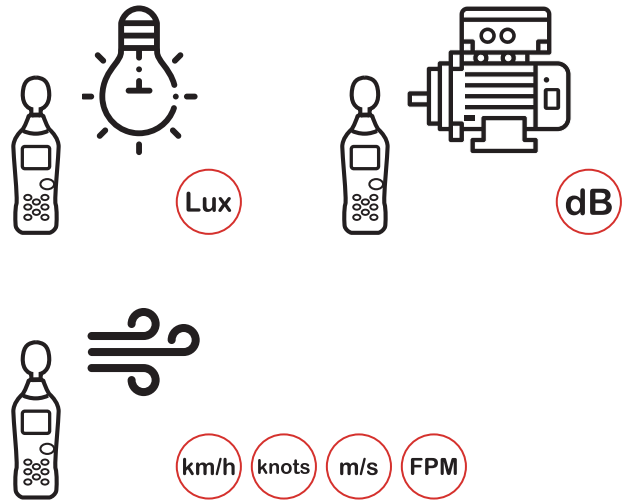

CONTENTS

- 280x89x50mm
11.0"x3.5"x2.0"
433g/0.95lb
- 1x9V 6F22 Battery
- Windbreak Holder
- Holder
- Wrapping case
- Battery
- Calibration Certificate
- Quick Start Guide

PACKAGING INFORMATION

- Color Box**
L325xW80xH160mm
- Carton Box**
42x35x35cm
- X 10PCS**

INDUSTRIAL TESTERS

STUD METAL DETECTOR | TACHOMETERS
LASER DISTANCE METERS





MAIN APPLICATIONS

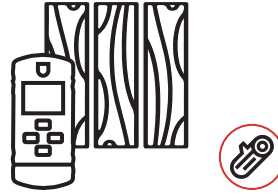

CONTENTS



160×74×42mm
6.3"×2.9"×1.65"
154g/0.33lb



1×9V 6F22
Battery



ACCESSORIES

Battery



Calibration
Certificate



Quick Start
Guide

ELECTRONIC STUD METAL FINDER
MS6906

SKU NO.: MS6906CBGLO
UPC CODE: 810053674574
EAN CODE: 8435394779645

FEATURE

- Auto Power Off.
- Low Battery Display.
- Display Backlight, Work Light.

SPECIFICATIONS

Wooden Pillar
30mm

Metal Stud Detection Depth
30mm

Metal Pipe Detector Depth
50mm

AC Voltage Detector Depth(50~600VAC)
75mm

PACKAGING INFORMATION



Color Box
L145×W60×H188mm



Carton Box
40×32×31.5cm



X 20PCS



DIGITAL TACHOMETER (Contact)
MS6208A

SKU NO.: MS6208ACBGLO
 UPC CODE: 810053672167
 EAN CODE: 8435394777887

FEATURE

- Contact Measuring Mode.
- Unit Selection m/min, m/sec, ft/min, ft/sec, in/min
- Auto Power Off.

SPECIFICATIONS

Ranging (contact)
50~19,999RPM

MAIN APPLICATIONS

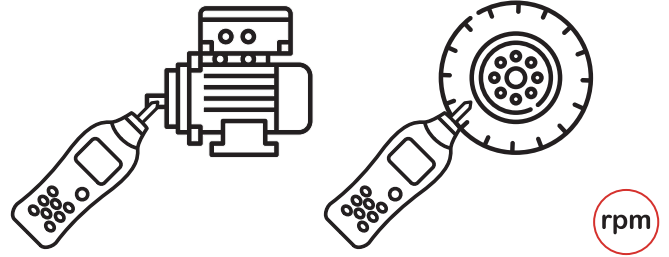

CONTENTS

- | | | | |
|--|---|--|-------------------------|
| | 170×60×27mm
6.7"×2.4"×1.1"
130g/0.28lb | | 4×1.5AAA
Batteries |
| | Measurement idler wheels
Touch tips
Lengthening bar
Carry bag
Battery | | Calibration Certificate |
| | | | Quick Start Guide |

PACKAGING INFORMATION

- | | | |
|--|------------------------------------|---------|
| | Color Box
L95×W45×H195mm | |
| | Carton Box
41.5×27×41cm | X 40PCS |



DIGITAL TACHOMETER (Non-Contact)

MS6208B

SKU NO.: MS6208BCBGLO
 UPC CODE: 810053672174
 EAN CODE: 8435394777894

FEATURE

- Non-Contact Measuring Mode.
- Measuring Distance 50mm~250mm.
- Auto Power Off.
- MAX/MIN.

SPECIFICATIONS

Ranging (non-contact)
50~99,999 RPM

MAIN APPLICATIONS

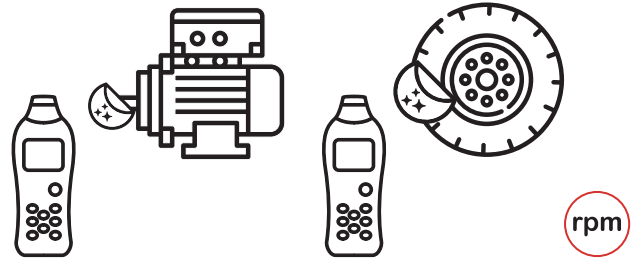

CONTENTS



155×60×27mm
 6.1"×2.4"×1.1"
 120g/0.26lb



4×1.5 AAA
 Batteries



ACCESSORIES

Reflective sheetin
 Carry bag
 Battery



Calibration
 Certificate



Quick Start
 Guide

PACKAGING INFORMATION



Color Box
 L95×W45×H195mm



Carton Box
 41.5×27×41cm



X 40PCS



MAIN APPLICATIONS

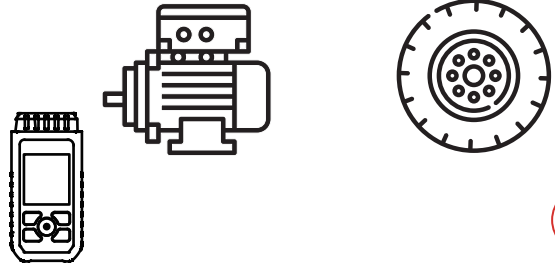

rpm

CONTENTS



152x55x33mm
5.9"x2.2"x1.3"
125g/0.28lb



1.5V AAA*3



ACCESSORIES

Carry bag
Reflective tape*2
Battery



Calibration Certificate



Quick Start Guide

TACHOMETER

MS6208C

SKU NO.: MS6208CCBGLO
EAN CODE: 8435394788852

FEATURE

- Screen Size: 37*41mm
- Display: 6 digits, max 999999
- Auto Power Off

SPECIFICATIONS

Range
2.5RPM~99999RPM(rpm/mins)

Temperature
0~60°C

Effective Distance
50~500mm

PACKAGING INFORMATION



Color Box
L89xW42xH210mm



Carton Box
45x38x23cm



X 40PCS



LASER DISTANCE METER
MS6406B

SKU NO.: MS6406BCBGLO
EAN CODE: 8435394789019

FEATURE

- Single Distance Measurement
- Area / Volume / Pythagorean Measurement
- Measurement Benchmark Switch
- Data Storage 99 Groups

SPECIFICATIONS

Range 0.05m~60m	Measurement Unit m, ft, in	Area Unit m², ft², in²
Laser Type 620~690nm	Laser Class Class II, <1mW	

MAIN APPLICATIONS

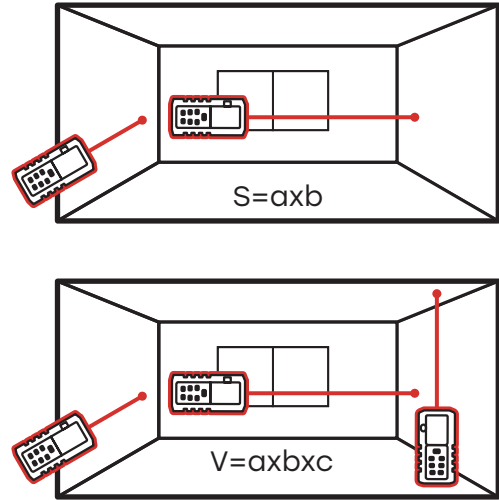

CONTENTS

- 130x59x28mm
5.12"x2.32"x1.1"
120g/0.26lb
- 1.5V AAA*3
- Strip
- USB cable
- Battery
- Calibration Certificate
- Quick Start Guide

PACKAGING INFORMATION

- Color Box**
L75xW55xH155mm
- Carton Box**
41x32.5x30.5cm
- X 50PCS**



LASER DISTANCE METER
MS6408B

SKU NO.: MS6408BCBGLO
EAN CODE: 8435394789026

FEATURE

- Single Distance Measurement
- Area / Volume / Pythagorean Measurement
- Measurement Benchmark Switch
- Data Storage 99 Groups

SPECIFICATIONS

Range 0.05m~80m	Measurement Unit m, ft, in	Area Unit m², ft², in²
Laser Type 620~690nm	Laser Class Class II, <1mW	

MAIN APPLICATIONS

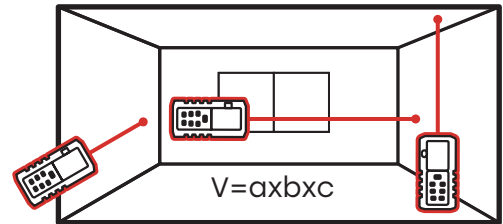
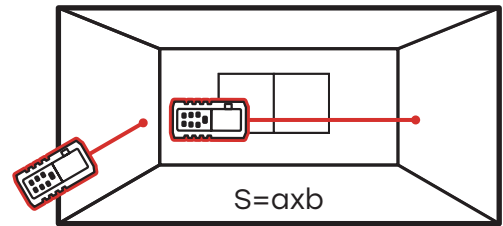

CONTENTS

- 130x59x28mm
5.12"x2.32"x1.1"
120g/0.26lb
- 1.5V AAA*3
- Strip
USB cable
Battery
- Calibration Certificate
- QSG
Quick Start Guide

PACKAGING INFORMATION

- Color Box**
L75xW55xH155mm
- Carton Box**
41x32.5x30.5cm
- X 50PCS**



LASER DISTANCE METER
MS6410B

SKU NO.: MS6410BCBGLO
EAN CODE: 8435394789033

FEATURE

- Single Distance Measurement
- Area / Volume / Pythagorean Measurement
- Measurement Benchmark Switch
- Data Storage 99 Groups

SPECIFICATIONS

Range 0.05m~100m	Measurement Unit m, ft, in	Area Unit m², ft², in²
Laser Type 620~690nm	Laser Class Class II, <1mW	

MAIN APPLICATIONS

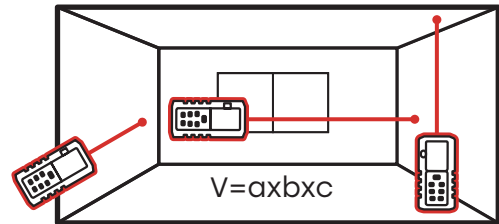
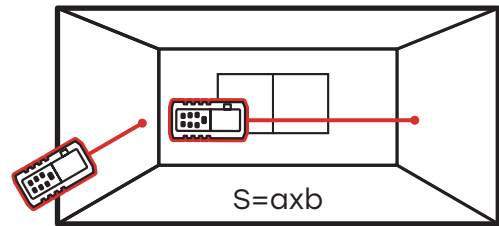

CONTENTS

- 130x59x28mm
5.12"x2.32"x1.1"
120g/0.26lb
- 1.5V AAA*3
- Strip
- USB cable
- Battery
- Calibration Certificate
- Quick Start Guide

PACKAGING INFORMATION

- Color Box**
L75xW55xH155mm
- Carton Box**
41x32.5x30.5cm
- X 50PCS**

TEST LEADS

T3009U

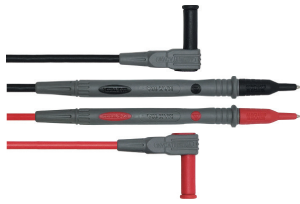

SKU NO..	UPC CODE	EAN CODE
T3009UPEGLO		
- Probe Length: 146mm/ø10.2mm Right Angle Type, M4 screw - Length: 1200mm - Tip: ø2mm	- Plug: ø4.5mm - Wire: UL 1803/18AWG - MAX 10A	

TEST LEADS

T3033U



SKU NO..	UPC CODE	EAN CODE
T3033UPEGLO	810053672785	8435394778426
- Probe Length: 119mm/ø9mm - Length: 800mm - Tip: ø2mm	- Plug: ø4.5mm - Wire: UL 1803/20AWG - MAX 10A	

TEST LEADS

T3016U



SKU NO..	UPC CODE	EAN CODE
T3016UPEGLO	810053674000	8435394779072
- Probe Length: 132mm/ø10mm Right Angle Type, M4 screw - Length: 1000mm - Tip: ø2mm	- Plug: ø4.5mm - Wire: UL 1803/18AWG - MAX 10A	

TEST LEADS

T3060A



SKU NO..	UPC CODE	EAN CODE
T3060APEGLO	810053674819	8435394783482
- Probe Length: 132mm/ø10mm Right Angle Type, M4 screw - Length: 1000mm - Tip: ø2mm	- Plug: ø4.5mm - Wire: UL 1803/18AWG - MAX 10A	

TEST LEADS

T3030U



SKU NO..	UPC CODE	EAN CODE
T3030UPEGLO	810053672778	8435394778419
- Probe Length: 143mm/ø10mm - Length: 1000mm - Tip: ø2mm	- Plug: ø4.5mm - Wire: UL 1803/18AWG - MAX 10A	

TEST LEADS

T3060B



SKU NO..	UPC CODE	EAN CODE
T3060BPEGLO	810053674826	8435394779881
- Probe Length: 132mm/ø10mm Right Angle Type, M4 screw - Length: 1500mm - Tip: ø2mm	- Plug: ø4.5mm - Wire: UL 1803/18AWG - MAX 10A	

Alligator Clip

C3109A

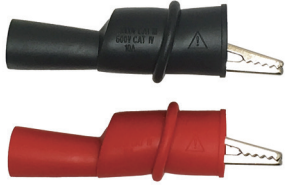

SKU NO..	UPC CODE	EAN CODE
C3109APEGLO	810053674901	8435394782355

- Length: 61.5mm
- with M4 screw

Medium Alligator Clip

C3109B



SKU NO..	UPC CODE	EAN CODE
C3109BPEGLO	810053673249	8435394778723

- Length: 55mm
- with M4 screw

THERMOCOUPLES

P3400

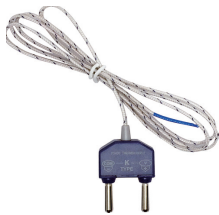

SKU NO..	UPC CODE	EAN CODE
P3400PEGLO	810053676752	8435394779867

- Length: 1000mm
- Ranging: -40~260°C (-40~500°F)

MASTECH®

www.mastech-group.com



MASTECH FORMOSA CORPORATION

✉ service@mastech-group.com

8F., No. 537, Tanmei St.,
Neihu Dist., Taipei City 114044,
Taiwan R.O.C.

Tel: +886 2-2508-0877

www.mastech-group.com



ABOUT US