

MASTECH®



CATALOGUE 2024

MEASURING INSTRUMENTS CATALOGUE

CONTENT INDEX

2	WHO IS MGL
3	ABOUT MASTECH
4	FAST SELECTION CHARTS
42	NEW PRODUCT
91	DIGITAL MULTIMETERS
151	DIGITAL CLAMP METERS
186	AC LINE SPLITTERS
190	ELECTRICAL TESTERS
200	CIRCUIT TESTERS
206	CIRCUIT ANALYZERS
211	WIRE & CABLE TESTERS
217	LCR METERS
223	EARTH RESISTANCE
229	INSULATION TESTERS
235	THERMOMETERS
245	ENVIRONMENTAL METERS
266	ACCESSORIES

WHO IS MGL

We are a global group of companies operating locally. We manufacture test and measurement products for the electrical and automotive industry, from the entry level through high tech products.

Our companies work globally, serving our customers worldwide. This global network delivers a deeper understanding of each individual market, with solutions tailored to the unique requirements of each customer.

With customers over 20 years old, our goal is to be a recognized, honest and fair company. We aim to be the most valued partner for our customers in the research, development, manufacture and supply of innovative, modern and customer-focused technologies.

We have a highly experienced team which is openminded, receptive to new ideas and adaptive to evolving market trends. This solid foundation guarantees that we are well informed and fully equipped to deliver excellent solutions to meet our customers' real needs.

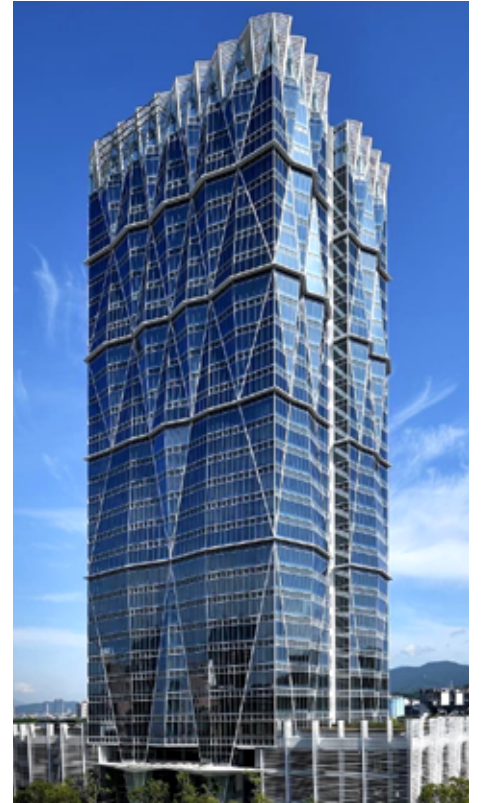

BRANDING CHANNELS

We manufacture electrical test and measurement instruments under our own brands: Mastech, KPS, C-Logic and Power Probe, recognized brands and market leaders in the fields of electrical measurement and automotive. All of our products have a professional positioning based on advanced balanced technology and they are marketed through local distributors throughout the world. We maintain direct and close contact with our distributors, through our offices around the world, and we support them in their business by offering technical advice and an after-sales service for our products.

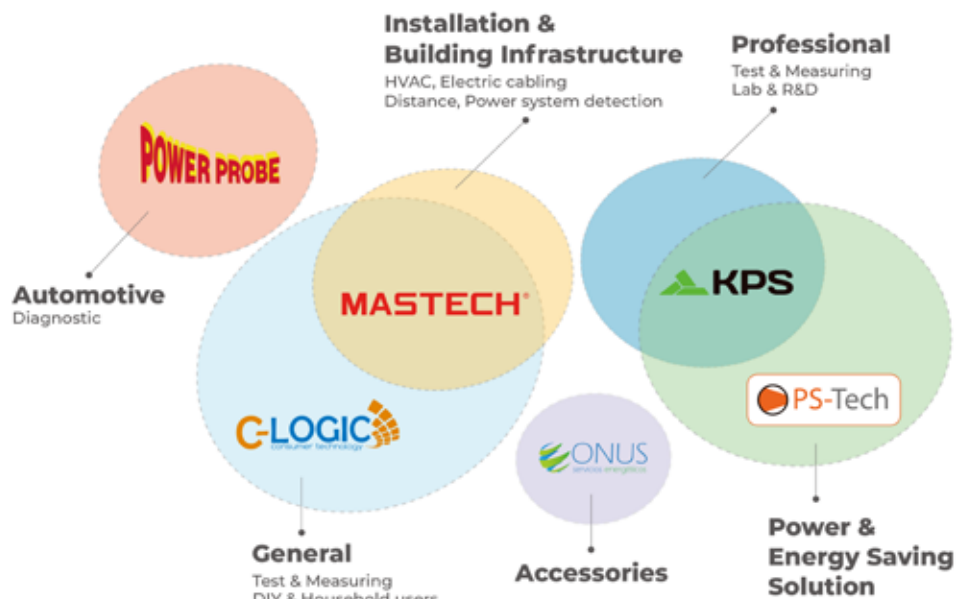

MASTECH®

At MASTECH we focus on providing the highest quality, innovative measuring instruments for the electrical market, along with the best service to our customers.

From digital multimeters and clamp meters to voltage testers, plug testers and all ranges of environmental testers, our product families have been developed to meet the requirements of the construction, DIY and industrial sectors.

Test and measurement equipment:

- I. For industrial environments: we develop a range of measuring instruments with specific features and high precision, ensuring reliability and accuracy.
- II. For the residential sector: MASTECH instruments meet all requirements relating to measuring and testing of electrical values, enabling safety checks on installations and appliances in homes and other buildings.
- III. For environmental measurement, MASTECH offers a wide range of solutions, with measuring instruments for temperature, moisture and wind speed to light, sound, gas and distance.



DIGITAL MULTIMETERS MANUAL RANGING

CAT II
CAT III
CAT IV



Model	MS830M	MS830T	MS830N	MS850A	MS850B	MS850C	MS850D
Page	42	43	44	45	46	47	48
Safety Rating	CAT III 600V	CAT III 600V	CAT III 600V	CAT III 600V	CAT III 600V	CAT III 600V	CAT III 600V
Resistance	200MΩ	200MΩ	20MΩ	200MΩ	20MΩ	40MΩ	60MΩ
DCV	600V	600V	600V	600V	600V	600V	600V
ACV	600V	600V	600V	600V	600V	600V	600V
V-Lowz	-	-	-	-	-	-	-
DCA/ACA	10A/10A	10A/10A	10A/10A	10A/10A	10A/10A	10A/10A	10A/10A
Frequency	400Hz	1000Hz	400Hz	1000Hz	1000Hz	1000Hz	1000Hz
Capacitance	-	200uF	-	-	-	100mF	100mF
°C	-	-20°C~1000°C	-	-	-20°C~1000°C	-	-20°C~1000°C
°F	-	-4°F~1832°F	-	-	-4°F~1832°F	-	-4°F~1832°F
Battery Test	-	1.5V, 3V, 9V	1.5V, 3V, 9V	1.5V, 3V, 9V	1.5V, 3V, 9V	1.5V, 3V, 9V	-
Frequency	-	2KHz	-	-	-	10MHz	10MHz
Diode	✓	✓	✓	✓	✓	✓	✓
Transistor Test	-	-	✓	✓	-	✓	✓
Buzzer	✓	✓	✓	✓	✓	✓	✓
Continuity	✓	✓	✓	✓	✓	✓	✓
Input Impedance	≥10MΩ	≥10MΩ	≥10MΩ	≥10MΩ	≥10MΩ	≥10MΩ	≥10MΩ
LED	-	-	✓	✓	✓	✓	✓
Bar Graph	-	-	-	-	-	-	-
V.F.C	-	-	-	-	-	-	-
NCV / Live	-	✓	✓	✓	✓	✓	✓
Max Display	2000	2000	2000	2000	2000	4000	6000
True RMS	-	✓	-	✓	✓	✓	✓
Duty Cycle	-	-	-	-	-	0.1%~99.9%	0.1%~99.9%
Square Wave Output	-	-	-	-	-	-	-
Max / Min	-	-	-	-	✓	✓	✓
REL	-	-	-	-	✓	✓	✓
Relative	-	-	-	-	✓	✓	✓
Low Impedance	-	-	-	-	-	-	-
Overload Protection	-	✓	✓	✓	✓	-	✓
Unit Display	✓	✓	✓	✓	✓	✓	✓
Auto Power Off	✓	✓	✓	✓	✓	✓	✓
Data Hold	✓	✓	✓	✓	✓	✓	✓
Backlight	✓	✓	✓	✓	✓	✓	✓
Dual Backlight	-	-	-	-	-	-	-
Flashlight	-	-	-	✓	✓	✓	✓







DIGITAL MULTIMETERS
MANUAL RANGING

CAT II
CAT III
CAT IV



Model	MS8239D+	MS8239T	MS890A	MS890B	MS890C+	MS890D+
Page	49	50	51	52	53	54
Safety Rating	CAT III 600V	CAT III 600V	CAT IV 600V CAT III 1000V	CAT IV 600V CAT III 1000V	CAT IV 600V CAT III 1000V	CAT IV 600V CAT III 1000V
Resistance	40MΩ	40MΩ	200MΩ	40MΩ	60MΩ	40MΩ
DCV	600V	600V	1000V	1000V	1000V	1000V
ACV	600V	600V	750V	750V	750V	750V
V-Lowz					600V	
DCA/ACA	10A/10A	10A/10A	10A/10A	20A/20A	10A/10A	20A/20A
Frequency	1000Hz	1000Hz	400Hz	1000Hz	1000Hz	1000Hz
Capacitance	40.00mF	40.00mF	200uF			100mF
°C		-20°C~750°C	-20°C~1000°C		-20°C~1000°C	
°F		-4°F~1832°F			-4°F~1832°F	
Battery Test				1.5V, 3V, 9V	1.5V, 3V, 9V	1.5V, 3V, 9V
Frequency	10MHz	10MHz	200KHz			10MHz
Diode	•	•	•	•	•	•
Transistor Test			•	•		•
Buzzer	•	•	•	•	•	•
Continuity	•	•	•	•	•	•
Input Impedance	≥10MΩ	≥10MΩ	≥10MΩ	≥10MΩ	≥10MΩ	≥10MΩ
LED	•	•		•	•	•
Bar Graph						
V.F.C						
NCV / Live	•	•		•	•	•
Max Display	4000	4000	2000	2000	2000	4000
True RMS	•	•	•	•	•	•
Duty Cycle						
Square Wave Output						
Max / Min	•	•			•	•
REL	•	•			•	•
Relative	•	•			•	•
Low Impedance						
Overload Protection	•	•	•	•	•	
Unit Display	•	•		•	•	•
Auto Power Off	•	•	•	•	•	•
Data Hold	•	•	•	•	•	•
Backlight	•	•		•	•	•
Dual Backlight						
Flashlight			•	•	•	•







DIGITAL MULTIMETERS MANUAL RANGING

							
Model	MS2003A	MS2003B	MS2103A	MS2103B	MS2109B	MS2109C	MS2109D
Page	55	56	57	58	59	60	61
Safety Rating	CAT III 600V	CAT III 600V	CAT III 600V	CAT III 600V	CAT III 600V	CAT III 600V	CAT III 600V
Resistance	40MΩ	60MΩ	60MΩ	40MΩ	20MΩ	40MΩ	60MΩ
DCV	600V	600V	600V	600V	600V	600V	1000V
ACV	600V	600V	600V	600V	600V	600V	750V
DCA			200A	200A			1000A
ACA	200A	200A	200A	200A	600A	600A	1000A
Frequency	1000Hz	1000Hz	1000Hz	1000Hz	60Hz	1000Hz	1000Hz
Capacitance	4mF	60mF	60mF	4mF		10mF	10mF
°C	-20°C~1000°C	-20°C~1000°C		-20°C~1000°C		-20°C~1000°C	-20°C~1000°C
°F	-4°F~1832°F	-4°F~1832°F		-4°F~1832°F		-0°F~1800°F	-0°F~1800°F
Frequency	10MHz	1KHz	1MHz	10MHz		10MHz	10MHz
Diode	•	•	•	•	•	•	•
Continuity	•	•	•	•	•	•	•
Input Impedance	≥10MΩ	≥10MΩ	≥10MΩ	≥10MΩ	≥10MΩ	≥10MΩ	≥10MΩ
Max Jaw Opening	19mm	19mm	19mm	19mm	23mm	23mm	23mm
LED	•	•	•	•	•	•	•
NCV / Live	•	•	•	•	•	•	•
Max Display	4000	6000	6000	4000	2000	4000	6000
True RMS	•	•	•	•		•	•
Duty Cycle		•		•		•	•
Inrush Current							•
MAX / MIN	•			•			
Relative	•		•	•		•	•
600mA Fuse			•				
Auto Identify ACV / DCV		•					
LPF(ACV)					•		
V.F.C		•					
Overload Protection	•	•	•	•	•	•	•
Unit Display	•	•	•	•	•	•	•
Auto Power Off	•	•	•	•	•	•	•
Data Hold	•	•	•	•	•	•	•
Backlight	•	•	•	•	•	•	•
Flashlight					•	•	•

Infrared Thermometer

	CAT II CAT III CAT IV				
					
Model	MS6523A	MS6523B	MS6523C	MS6525A	MS6525B
Page	62	63	64	65	66
Range	-50°C~500°C -58°F~932°F	-50°C~700°C -58°F~1292°F	-50°C~900°C -58°F~1652°F	-32°C~1100°C -26°F~2012°F	-32°C~1400°C -26°F~2552°F
Accuracy	0°C~500°C ±(1.5%+1°C) / 32°F~932°F ±(1.5%+5°F) -50°C~0°C (±3°C) / -58°F~32°F (±5°F)			-32~100°C (±2°C) / -26~212°F (±4°F) 100~800°C (±2%) / 212~1472°F (±2%) 800°C above (±3%) / 1472°F above (±3%)	
Repeatability	±0.5% / ±1°C (2°F)			±1% / ±1°C (2°F)	
Display resolution	0.1°C (0.1°C)			-32°C~1000°C (0.1°C) / 1000 above 1°C	
Response time	Less than 500ms			<500ms (95% of reading)	
Spectral response	8µm~14µm			8µm~14µm	
Emissivity	0.1~1.00 adjustable (step size 0.01)			0.1 to 1.00 adjustable in steps of 0.01 (default 0.95)	
Measuring object distance ratio	12:1			50:1	
Laser aiming	Less than 1mW 650nm laser grade: class 2			Wavelength 620~690nm, output less than 1mW, laser grade: class 2	
°C/°F Conversion	•			•	
Display mode	VA Color Screen			VA Color Screen	
Screen Size	30*27mm			41*39mm	
Overrange prompt	"HI" or "LO"			"HI" or "LO"	
Operating temperature	0°C~50°C (32°F~122°F)			0°C~50°C (32°F~122°F)	
Operating humidity	10~95%RH Non condensing			≤95%RH Non condensing	
Storage temperature	-20°C~60°C Not including batteries			-20°C~60°C (-4°F~140°F)	
Backlight	•			•	

Infrared Thermometer

	  			
				
Model	MS6503	MS6512A	MS6512B	MS6512C
Page	67	68	69	70
Type	Dual Channel	Single Channel	Dual Channel	Four Channel
Temperature Difference	•		•	
Measuring Range	K-type: -200°C~1372°C (-328°F~2501°F), J-type: -200°C~1372°C (-328°F~2501°F)		K-type: -200°C~1372°C (-328°F~2501°F), J-type: -200°C~1372°C (-328°F~2501°F)	
Resolution	(-100°C~-200°C) 1°C / 1 °F, (-99°C~999.9°C) 0.1°C / °F, (>1000°) 1°C / °F		(-99°C~999.9°C) 0.1°C / °F, (-100°C~-200°C, ≥1000°C) 1°C / °F	
Accuracy	±(0.2%+0.7°C)		±(0.2%+0.7°C)	
Upper Limit Alarm	Default value: 1300°C		Default value: 1300°C	
Lower Limit Alarm	Default value: -200°C		Default value: -200°C	
ADJ Compensation	-9°C~9°C		-9°C~9°C	
USB Connection				•
Data logger	9999 groups, Only store thermocouple temp. data (not support ambient temp, data)			5000 groups
Ambient Temp.	0°C~60°C		0°C~60°C	
Accuracy	±2°C		±2°C	
Recoerding interval time setting			H:M / M:S	
Bracket num			¼inch nut	
Sampling Rate	1 time/s		1 time/s	
Auto Power Off	10min		10min (can be canceled manually)	
Working Environment	-10°C~50°C, max 80%RH, indoor altitude <2000m		-10°C~50°C, max 80%RH, indoor altitude <2000m	
Storage Environment	-10°C~50°C, max 70%RH (Battery removed)		-10°C~50°C, max 70%RH (Battery removed)	
K Type Temp. probe	Random configuration probe Measurement range: -20°C~200°C (Accuracy ±2.5%)		Random configuration probe Measurement range: -50~300°C (Accuracy ±1.5%)	
Max / Min	•		•	
Data Hold	•		•	
Backlight	•			

Infrared Thermometer



Model	MS6509
Page	71
LCD display	•
Backlight	•
Auto Power Off	•
Max / Min	•
Data Hold	•
Temperature Range	0°C~60°C/ 32°F~140°F
Temperature Accuracy	0.1°C/ 0.1°F
Humidity	0%~100%RH
Humidity Resolution	0.1%RH
Measuring Display	4 digits, max 9999
Battery	3*1.5V AAA

Moisture Meter



Model	MS6901
Page	72
LCD display	•
Backlight	•
Auto Power Off	•
Hi / LOW	•
Data Hold	•
Measuring Range	0~54.8%RH
Resolution	0.1%RH
Humidity	0%~100%RH
Measuring Display	4 digits, max 1999
Test Probe	M3 metric tooth test Pin, external hexagon 5mm
Accuracy	±1%
Overload	Hi or LO
Ambient Temp.	0~60°C
Sampling Rate	2 time/s
Auto Power Off	10min (can be canceled manually)
Working Environment	-10°C~50°C, max 80%RH, indoor altitude <2000m
Storage Environment	-10°C~50°C, max 70%RH (battery removed)
Battery	3*1.5V AAA

Tachometer



Model	MS6208C
Page	73
Range	2.5RPM~99999RPM(rpm/min)
Resolution	2.5RPM~999RPM(0.1RPM) 1000RPM above(1RPM)
Accuracy	±(0.05% reading+1 digit)
Display	6digits, max 999999
Ambient Temp.	0~60°C, ±2°C
Effective Distance	50mm~500mm
Sampling Rate	Approx. 0.8s(over 60rpm/min)
Working Environment	-10°C~50°C, max 80%RH, indoor altitude <2000m
Storage Environment	-10~50°C, max 70%RH (battery removed)
Auto power off	•
Max/Min	•
Data Hold	•
Backlight	•
Battery	3*1.5V AAA

Wire Tracker Transmitter



Model	MS6815B
Page	74
Digital wire tracking	•
Wire alignment	•
Continuity test	LED indication
Circuit voltage test	LED indication
Telephone line status	LED indication
POE switch tracking	•
Adjustable sensitivity	Adjustable within 0-5cm
Flashlight	Receiver with flashlight
Display mode	LED indicatio
Output signal level	About 5Vp-p
Max working current	Emitters60mA / Receivers80
Transmitting signal distance	≤3km
Low battery indication	Prompt when less than 7.2V
Battery	2*6F22 9V Batter

Digital Light Meter



Model	MS6512A	MS6512B	MS6613B
Page	75	76	77
Measuring Range	0~200KLUX, 0FC~20KFC	0.1~200000LUX	
Measuring Level	999.9/99999/19999*10 LUX 99.9/999.9/19999 FC		
Accuracy	±3%rdg±8dgts (<10000LUX), ±4%rdg±10dgts (>10000LUX)	±(3%+5LUX) (calibrated under the standard incandescent lamp at color temperature 2856°F) ±(6%+5LUX) other visible light cosine angle deviation feature 30°±2%, 60°±6%, 80°±25%	
Resolution	LUX: < 1000:0.1LUX, ≥1000:1LUX; FC: < 100:0.1FC, <1000:0.1LUX, ≥1000:1FC		
Display	4 digits, max 9999	5 digits, max 99999	
Ambient Temp.	0°C~60°C	0°C~60°C	
Accuracy	±2°C	±2°C	
Light sensor	Digital Light Probes and Filters		
Sampling Rate	500ms	8time/s	
Incident angle	120°		
Repeated test deviation	±2%		
Spectral range	400~700nm		
USB connection	•		
Auto power off	15min(can be canceled manually)		
Screen size	53*44mm		
Working Environment	-20°C~60°C / -4°F~140°F, 10RH%~90RH%	-10°C~50°C, max 80%RH, Indoor altitude < 2000m	
Storage Environment	-20°C~60°C / -4°F~140°F, 10RH%~75RH%	-10°C~50°C, max 70%RH (Battery removed)	
Max / Min	•	•	
Data Hold	•	•	
Backlight	•	•	
Battery	3*1.5V AAA	3*1.5V AAA	3*1.5V AAA

Digital Anemometer



Model	MS6652C	MS6253A	MS6253B
Page	78	79	80
Measurement Method	Integral Type		
Air Velocity Range	0.4~30.0m/s 1.4~108km/h 80~5900ft/m 0.9~67.0mph 0.8~58.0knots	0.06~45.0m/s 1.0~162.0Km/h 10~8858ft/m 1.0~147.6ft/s 1.0~100.6mile/h 0.1~84.48Knots	
Accuracy	±(3.0%+0.3m/s)	±(2% reading+0.2)	
Resolution	0.1	0.01/0.1/1	
Bft	0~12	0~12	
Air Temp. Range	0°C~60°C (32°F~140°F)	0°C~45°C (32.0°F~113.0°F)	
Accuracy	±1.5°C (±2.7°F)	±2°C (±3.6°F)	
Air Volume measurement	CMM 0~9999 CFM 0~9999	CFM 0~9999ft3 / min CMM 0~9999m3 / min CMS 0~9999m3 / s	
Resolution	0.1	0.1	
Display	4 digits, max 9999	4 digits, max 9999	
Sensor	Magnetic induction wind speed sensor and negative temperature coefficient temperature sensor	Infrared Laser Tube Cutting Method	
Sampling Rate	0.5sec	2time/s	
Repeated test deviation		±2%	
Data logger		1000groups	
USB connection			•
Synchronous update	•	Refer to PC information for program update	
Auto power off		15min(can be canceled)	
Working Environment	0°C~40°C, max 80%RH	-10°C~50°C, max 80%RH, Indoor altitude < 2000m	
Storage Environment	-10°C~60°C, max 70%RH	-10°C~50°C, max 70%RH (Battery removed)	
Max / Min	•	•	•
Data Hold	•	•	•
Backlight	•		
Battery	3*1.5V AAA	3*1.5V AA	3*1.5V AA

Digital Sound Level Meter



Model	MS6702A	MS6703A	MS6703B
Page	81	82	83
Microphone	1/2 inch	1/2 inch	
Range	35~135dB	30~70dB, 60~90dB, 80~110dB, 100~130dB	
Accuracy	±2.0dB	±1.5dB (sound pressure reference 94dB@1kHz)	
Frequency Weighting	A	A / C	A / C / Z
Time Weighting	FAST: 125ms/SLOW: 1s	FAST: 0.125 Sec/SLOW: 1 Sec	
Sampling Rate	2time/s		
Frequency	31.5Hz~8KHz	31.5Hz~8KHz	
Analog Bar	One scale represents 1dB		
Display	4 digit	4 digit, max1999	
Ambient Temperature	0°C~60°C/32°F~140°F, ±1.5°C (±1.8°F)	0°C~60°C, ±2°C	
Overload	OVER "Hi", UNDER "LO"	OVER "Hi", UNDER "LO"	
Analog Signal Output	AC / DC signal is output by the headphone jack socket: AC=100Vrms, DC=10mV/db		
USB Connection			•
Data Logger	1999groups		
Synchronous Update	Refer to PC information for program update		
Auto Power Off	15min(can be canceled)		
Working Environment	0°C~40°C, 10RH%~80RH%	-10°C~50°C, max 80%RH, indoor altitude < 2000m	
Storage Environment	-10°C~60°C, 10RH%~70RH	-10°C~50°C, max 70%RH (battery removed)	
Max / Min	•	•	•
Data Hold	•	•	•
Backlight	•		
Battery	3*1.5V AAA	3*1.5V AA	3*1.5V AA

Laser Distance Meter



Model	MS6406B	MS6408B	MS6410B
Page	84	85	86
Range	60m	80m	100m
Accuracy	±2.0mm	±2.0mm	±2.0mm
Measurement Unit	m, ft, in	m, ft, in	m, ft, in
Area Unit	m ² , ft ² , in ²	m ² , ft ² , in ²	m ² , ft ² , in ²
Laser Type	620~690nm	620~690nm	620~690nm
Laser Class	Class II, <1mW	Class II, <1mW	Class II, <1mW
Single Measurement	0.25s	0.25s	0.25s
Working Temp.	0~+40°C	0~+40°C	0~+40°C
Storage Temp.	-10~+50°C	-10~+50°C	-10~+50°C
Measurement Per Battery Pack	Approx. 1000	Approx. 1000	Approx. 1000
Automatic Laser Shut Down	After 30s	After 30s	After 30s
Automatic Device Shut Down	After 180s	After 180s	After 180s
Area / Volume Measurement	•	•	•
Indirect Pythagorean Theorem Measureme	•	•	•
Addition / Subtraction	•	•	•
Continuous	•	•	•
Multi-line Display	•	•	•
MAX / MIN	•	•	•
Voice Broadcast	•	•	•
Electronic Level Display	•	•	•
Data Clearance	•	•	•
Error Codes	•	•	•
Battery Status	•	•	•
Data Storage	99 Groups	99 Groups	99 Groups
Battery	3*1.5V AAA	3*1.5V AAA	3*1.5V AAA

Socket Tester



Model	MS6861A	MS6863A
Page	87	88
AC Voltage	175~250V/50~60Hz	175~250V/50~60Hz
Accuracy	±(2.0%+2)	±(2.0%+2)
Working Temperature	0°C~40°C	0°C~40°C
Working Humidity	20%~75%RH	20%~75%RH
Storage Temperature	-10°C~50°C	-10°C~50°C
Storage Humidity	20%~80%RH	20%~80%RH
Altitude	≤2000 meters	≤2000 meters
Leakage Test Current	>30mA	>30mA
Leakage Test Voltage	AC 220V±20V	AC 220V±20V
LCD Panel diagram		•
Socket Specificatio	CHN plug, UK plug, EU plug, US plug	CHN plug, UK plug, EU plug, US plug

Gas Leak Detector



Model	MS6311A	MS6311B
Page	89	90
Range	%LEL: 0~20%, PPM: 0~9999PPM	
Resolution	%LEL: 0~20.0%(0.1), PPM: 0~9999PPM(0.1), 1000~9999PPM(1)	
Accuracy		±10%F.S.(CH4)
Display	Analog bar	Analog bar and value
Sensitivity	50PPM (CH4)	
Alarm mode	Display, sound & light alarm	
Auto zero	Auto-zero during warm-up process(in clean air)	
Sensor	Semiconductor sensor	
Ambient Temp.		0°C~60°C, ±2°C
Auto power off	15 mins(can be canceled manually)	
Detectable gas	Acetone,acetylene,alcohol, ammonia, benzene,butane, ethanol,oxirane, gasoline, hexane, hydrogen, methane, naphtha, natural gas, paint thinner, propane, solvent and etc	
Working Environment	-10°C~50°C, max 80%RH, indoor altitude <2000m	
Storage Environment	-10°C~50°C, max 70%RH	
Hi / Mid / Low	•	
Battery	3.7V/1000mAH LI-IO, USB micro interface (DC 5V/1A)	3.7V/1000mAH LI-IO, USB micro interface (DC 5V/1A)

DIGITAL MULTIMETERS
MANUAL RANGING

								
CAT II CAT III CAT IV								
Model	M3900	M830B	M830BZ	M832	M838	MAS830	MAS830B	MAS830L
Page	92	93	94	95	96	97	98	99
Safety Rating	CAT II 1000V CAT III 600V	CAT II 600V	CAT II 600V	CAT II 600V	CAT II 600V	CAT III 600V	CAT III 600V	CAT III 600V
Display Counts	2000	2000	2000	2000	2000	2000	2000	2000
Auto Ranging								
Auto Power Off								
True RMS								
DC Voltage	1000V	600V	600V	600V	600V	600V	600V	600V
AC Voltage	750V	600V	600V	600V	600V	600V	600V	600V
DC Current	10A	10A	10A	10A	10A	10A	10A	10A
AC Current	10A							
Resistance	20MΩ	2MΩ	2MΩ	2MΩ	2MΩ	2MΩ	2MΩ	2MΩ
Capacitance								
Frequency								
Duty Cycle								
Type K Temperature								-20~1370°C
Battery Test								
Diode	•	•	•	•	•	•	•	•
Continuity	•		•	•	•	•		•
Display Backlight								•
Work Light								•
Data Hold						•		•
NCV								
Inductance								
hFE Transistor	•	•		•	•			•
Dual Display								
MAX								
MAX/MIN								
MAX/MIN/AVG								
Relative Measurement								
Peak Measurement								
DWELL Test								
TACH Test								







DIGITAL MULTIMETERS
MANUAL RANGING

CAT II
CAT III
CAT IV







Model	MAS838	MS8233A	MS8233B	MS8233C	MS8238	MS8261	MS8264	MS8269
Page	100	101	102	103	104	105	106	107
Safety Rating	CAT III 600V	CAT III 600V	CAT III 600V	CAT III 600V	CAT II 600V	CAT II 1000V CAT III 600V	CAT II 1000V CAT III 600V	CAT II 1000V CAT III 600V
Display Counts	2000	2000	2000	2000	2000	2000	2000	2000
Auto Ranging								
Auto Power Off						•	•	•
True RMS								
DC Voltage	600V	600V	600V	600V	600V	1000V	1000V	1000V
AC Voltage	600V	600V	600V	600V	600V	750V	750V	750V
DC Current	10A	10A	10A	10A	10A	10A	10A	10A
AC Current						10A	10A	10A
Resistance	2MΩ	2MΩ	2MΩ	2MΩ	2MΩ	200MΩ	200MΩ	20MΩ
Capacitance						20μF	20μF	20μF
Frequency							20kHz	
Duty Cycle								
Type K Temperature	-20~1000°C			-20~1000°C -4~1832°F			-20~1000°C	-20~1000°C
Battery Test					•			
Diode	•	•	•	•	•	•	•	•
Continuity	•	•	•	•	•	•	•	•
Display Backlight			•	•		•	•	
Work Light								
Data Hold	•	•	•	•		•	•	•
NCV			•	•				
Inductance								20H
hFE Transistor						•	•	•
Dual Display								
MAX								
MAX/MIN								
MAX/MIN/AVG								
Relative Measurement								
Peak Measurement								
DWELL Test								
TACH Test								

DIGITAL MULTIMETERS
MANUAL RANGING

						
	CAT II CAT III CAT IV					
Model	MS8321A	MS8321D	MY60	MY61	MY62	MY63
Page	108	109	110	111	112	113
Safety Rating	CAT III 600V	CAT II 1000V CAT III 600V	CAT II 1000V CAT III 600V	CAT II 1000V CAT III 600V	CAT II 1000V CAT III 600V	CAT II 1000V CAT III 600V
Display Counts	2000	2000	2000	2000	2000	2000
Auto Ranging						
Auto Power Off	•	•	•	•	•	•
True RMS						
DC Voltage	600V	1000V	1000V	1000V	1000V	1000V
AC Voltage	600V	750V	750V	700V	750V	750V
DC Current	10A	20A	10A	10A	10A	10A
AC Current	10A	20A	10A	10A	10A	10A
Resistance	20MΩ	20MΩ	200MΩ	200MΩ	200MΩ	200MΩ
Capacitance				100μF	100μF	100μF
Frequency						2kHz
Duty Cycle						
Type K Temperature						-20~1000°C
Battery Test						
Diode	•	•	•	•	•	•
Continuity	•	•	•	•	•	•
Display Backlight						
Work Light						
Data Hold	•	•	•	•	•	•
NCV						
Inductance						
hFE Transistor	•	•	•	•	•	•
Dual Display						
MAX						
MAX/MIN						
MAX/MIN/AVG						
Relative Measurement						
Peak Measurement						
DWELL Test						
TACH Test						

DIGITAL MULTIMETERS
MANUAL RANGING

					
	CAT II CAT III CAT IV				
Model	MY64	MY65	MY70	MY74	MY75
Page	114	115	116	117	118
Safety Rating	CAT II 1000V CAT III 600V	CAT II 1000V CAT III 600V	CAT III 600V	CAT III 600V	CAT III 600V
Display Counts	2000	20000	2000	2000	20000
Auto Ranging					
Auto Power Off	•	•	•	•	•
True RMS					
DC Voltage	1000V	1000V	600V	600V	600V
AC Voltage	750V	700V	600V	600V	600V
DC Current	10A	10A	10A	10A	10A
AC Current	10A	10A	10A	10A	10A
Resistance	200MΩ	200MΩ	200MΩ	200MΩ	200MΩ
Capacitance	100μF	100μF		100μF	200nF
Frequency	20kHz	20kHz		20kHz	20kHz
Duty Cycle					
Type K Temperature	-20~1000°C		-20~1000°C		
Battery Test					
Diode	•		•	•	•
Continuity	•	•	•	•	•
Display Backlight					
Work Light					
Data Hold	•	•	•	•	•
NCV					
Inductance					
hFE Transistor	•	•	•	•	
Dual Display					
MAX					
MAX/MIN					
MAX/MIN/AVG					
Relative Measurement					
Peak Measurement					
DWELL Test					
TACH Test					





DIGITAL MULTIMETERS AUTO RANGING

CAT II
CAT III
CAT IV







Model	MS820L	MS8217	MS8221C	MS8233D	MS8233E
Page	119	120	121	122	123
Safety Rating	CAT II 600V CAT III 300V	CAT II 1000V CAT III 600V	CAT III 600V	CAT II 600V	CAT III 600V
Display Counts	2000	4000	2000	2000	2000
Auto Ranging		•	•	•	•
Auto Power Off	•	•	•	•	•
True RMS					
DC Voltage	500V	1000V	600V	600V	600V
AC Voltage	500V	1000V	600V	600V	600V
DC Current	10A	10A	10A	10A	10A
AC Current		10A	10A	10A	10A
Resistance	200MΩ	40MΩ	20MΩ	20MΩ	20MΩ
Capacitance		100μF	1000μF		
Frequency		100kHz	400Hz	20kHz	
Duty Cycle		•			
Type K Temperature		-55~1000°C	-20~1000°C		-20~1000°C -4~1832°F
Battery Test					
Diode	•	•	•	•	•
Continuity	•	•	•	•	•
Display Backlight	•			•	•
Work Light					
Data Hold	•	•		•	•
NCV				•	•
Inductance					
hFE Transistor			•		
Dual Display					
MAX				•	•
MAX/MIN					
MAX/MIN/AVG					
Relative Measurement		•			
Peak Measurement					
Low Pass Filter					
AC/DC Current (For Clamp)					
Low Impedance					
Bar Graph					
Interface					







DIGITAL MULTIMETERS
AUTO RANGING

					
	CAT II CAT III CAT IV				
Model	MS8238H	MS8239C	MS8251A	MS8251B	MS8268
Page	124	125	126	127	128
Safety Rating	CAT III 600V	CAT III 600V	CAT III 1000V CAT IV 600V	CAT III 1000V CAT IV 600V	CAT II 1000V CAT III 600V
Display Counts	4000	4000	6600	6600	4000
Auto Ranging	•	•	•	•	•
Auto Power Off	•	•	•	•	•
True RMS	•			•	
DC Voltage	600V	600V	1000V	1000V	1000V
AC Voltage	600V	600V	1000V	1000V	750V
DC Current	10A	10A	10A	10A	10A
AC Current	10A	10A	10A	10A	10A
Resistance	40MΩ	40MΩ	66MΩ	66MΩ	40MΩ
Capacitance		100μF	66mF	66mF	200μF
Frequency		10kHz	66MHz	10kHz	200kHz
Duty Cycle		•	•	•	•
Type K Temperature	-20~1000°C -4~1832°F	-20~1000°C -4~1832°F	0~1000°C 32~1832°F	0~1000°C 32~1832°F	
Battery Test	•				
Diode	•	•	•	•	•
Continuity	•	•	•	•	•
Display Backlight		•	•	•	•
Work Light					
Data Hold	•	•	•	•	•
NCV	•		•	•	
Inductance					
hFE Transistor					•
Dual Display			•	•	
MAX					
MAX/MIN			•	•	
MAX/MIN/AVG					
Relative Measurement			•	•	•
Peak Measurement					
Low Pass Filter					
Sound & Light Warning					•
Low Impedance				•	
Bar Graph				•	
Interface	Wireless				

DIGITAL MULTIMETERS AUTO RANGING

					
	CAT II CAT III CAT IV				
Model	MS8301D	MS8332C	MS8340A	MY68	MY78
Page	129	130	131	132	133
Safety Rating	CAT III 600V	CAT III 600V	CAT III 1000V	CAT II 1000V CAT III 600V	CAT II 1000V CAT III 600V
Display Counts	6000	4000	6000	4000	4000
Auto Ranging	•	•	•	•	•
Auto Power Off	•	•	•	•	•
True RMS					
DC Voltage	600V	600V	1000V	1000V	600V
AC Voltage	600V	600V	750V	700V	600V
DC Current		400mA	10A	10A	10A
AC Current		400mA	10A	10A	10A
Resistance	10MΩ	40MΩ	60MΩ	40MΩ	40MΩ
Capacitance		100μF	400μF	200μF	200μF
Frequency	3kHz	5MHz	10MHz	100kHz	200kHz
Duty Cycle	•	•	•		•
Type K Temperature			-10~700°C 14~1292°F		
Battery Test					
Diode		•	•	•	•
Continuity	•	•	•	•	•
Display Backlight	•	•	•		
Work Light					
Data Hold	•	•	•	•	•
NCV	•	•			
Inductance					
hFE Transistor				•	•
Dual Display	•				
MAX					
MAX/MIN	•		•		
MAX/MIN/AVG					
Relative Measurement			•		•
Peak Measurement					
Low Pass Filter			•		
AC/DC Current (For Clamp)					•
Low Impedance					
Bar Graph					
Interface					

DIGITAL MULTIMETERS
POCKET/PEN TYPE







							
	CAT II CAT III CAT IV						
Model	M300	M320	MS8333A	MS8211	MS8211D	MS8212A	MS8223A
Page	134	135	136	137	138	139	140
Safety Rating	CAT II 600V CAT III 300V	CAT II 600V CAT III 300V	CAT III 600V	CAT II 600V	CAT II 600V	CAT III 600V	CAT III 600V
Display Counts	2000	4000	6000	2000	2000	2000	2000
Auto Ranging		•	•	•	•	•	•
Auto Power Off		•	•	•	•	•	•
True RMS			•				
DC Voltage	600V	600V	600V	600V	600V	600V	600V
AC Voltage	600V	600V	600V	600V	600V	600V	600V
DC Current	200mA	400mA	600mA		200mA	200mA	200mA
AC Current		400mA	600mA		200mA	200mA	200mA
Resistance	20MΩ	40MΩ	60MΩ	20MΩ	20MΩ	20MΩ	20MΩ
Capacitance		100μF	600μF				
Frequency		100kHz	10kHz				
Duty Cycle			•				
Type K Temperature							
Battery Test			•				
Diode	•	•	•	•	•	•	•
Continuity	•	•	•	•	•	•	•
Display Backlight			•				
Work Light							•
Data Hold		•	•	•	•	•	•
NCV			•	•		•	•
Inductance							
hFE Transistor							
Dual Display							
MAX				•	•	•	•
MAX/MIN							
MAX/MIN/AVG							
Relative Measurement							
Peak Measurement							
DWELL Test							
TACH Test							
Logic Level Test					•	•	•
Retractable Tip				•	•		
Double Molding						•	•

**DIGITAL MULTIMETERS
BENCH TYPE**







 CAT II
 CAT III
 CAT IV

Model	MS8040	MS8050
Page	143	144
Safety Rating	CAT II 1000V	CAT II 1000V
Display Counts	22000	53000
Auto Ranging	•	•
Auto Power Off	•	•
True RMS	•	•
DC Voltage	1000V	1000V
AC Voltage	750V	1000V
DC Current	10A	10A
AC Current	10A	10A
Resistance	200MΩ	50MΩ
Capacitance	20mF	5000μF
Frequency		
Logic Frequency	220MHz	2MHz
Linear Frequency	100kHz	200kHz
Duty Cycle	•	•
OSC. Out		
Type K Temperature	-30~1300°C -22~2372°F	
Diode	•	•
hFE Transistor		
Continuity	•	•
Backlight	•	•
Data Hold	•	•
MAX/MIN/AVG	MAX/MIN	•
Relative Measurement	•	•
Peak Measurement	•	
Low Pass Filter	•	
Bar Graph	•	
DC Current (For Clamp)	220/2200A	
AC Current (For Clamp)	220/2200A	
ADP measurement		
Data Logging		30 Groups
Analysis Software		•
Interface	USB	USB







DIGITAL MULTIMETERS
SPECIAL APPLICATION

						
	CAT II CAT III CAT IV					
Model	MS5208	MS8209	MS8229	MS8236	MS8239D	MS8265
Page	145	146	147	148	149	150
Safety Rating	CAT III 1000V	CAT III 600V	CAT III 600V	CAT III 600V	CAT III 600V	CAT II 1000V CAT III 600V
Display Counts	6600	4000	4000	2000	2000	20000
Auto Ranging	•	•	•	•	•	•
Auto Power Off	•	•	•	•	•	•
True RMS	•					
DC/AC Voltage	1000V/750V	600V/600V	1000V/750V	600V/600V	600V/600V	1000V/750V
DC/AC Current	400mA/400mA	10A/10A	10A/10A	10A/10A	10A/10A	10A/10A
Resistance	66MΩ	40MΩ	40MΩ	20MΩ	40MΩ	200MΩ
Capacitance	66mF	200μF	100μF			200μF
Frequency	10kHz	200kHz	200kHz			20kHz
Duty Cycle	•	•				
Diode	•	•	•	•	•	•
Type K Temperature	-30~1300°C -22~2372°F	-20~1000°C -4~1832°F	-20~1000°C -4~1832°F			
Continuity	•	•	•	•	•	•
Display Backlight	•	•	•	•	•	•
Data Hold	•	•	•	•	•	•
NCV				•		
hFE Transistor						•
MAX				•	•	
MAX/MIN						
MAX/MIN/AVG	•					
Relative Measurement	•	•				
Low Pass Filter	•					
Insulation Test	1000V/2GΩ					
DAR/PI	•					
Relative Humidity		30~90%	20~95%			
Sound level		35~100dB	40~100dB			
Luminosity		40000Lux	4000/40000Lux			
Environment Temperature			0~40°C/32~104°F			
Cable Check						RJ11/RJ45/Tone
Sound & Light Warning			•			•
Data Logging	100 Groups					
Interface						
DWELL/TACH Test				•		

**DIGITAL CLAMP METERS
AC CURRENT**







							
	<p>CAT II CAT III CAT IV</p>						
Model	M266	M266C	M266F	MS2000G	MS2001	MS2001C	MS2001F
Page	150	151	152	153	154	155	156
Safety Rating	CAT II 1000V CAT III 600V	CAT II 1000V CAT III 600V	CAT II 1000V CAT III 600V	CAT II 1000V	CAT II 1000V CAT III 600V	CAT II 1000V CAT III 600V	CAT II 1000V CAT III 600V
Display Counts	2000	2000	2000	2000	2000	2000	2000
Jaw Size	Φ50mm 2.0"	Φ50mm 2.0"	Φ50mm 2.0"	Φ55mm 2.2"	Φ42mm 1.7"	Φ42mm 1.7"	Φ42mm 1.7"
Auto Ranging							
Auto Power Off							
True RMS							
DC Voltage	1000V	1000V	1000V	1000V	1000V	1000V	1000V
AC Voltage	750V	750V	750V	750V	750V	750V	750V
DC Current							
AC Current	1000A	1000A	1000A	2000A	1000A	1000A	1000A
Resistance	20kΩ	20MΩ	2MΩ	2MΩ	2000Ω	2000Ω	2000Ω
Capacitance							
Frequency			2kHz	20kHz			2kHz
Duty Cycle							
Type K Temperature		0~750°C 32~1382°F		0~750°C 32~1382°F		-40~750°C	
Diode			•	•	•		•
Continuity	•	•	•	•	•	•	•
Display Backlight				•	•	•	
Work Light							
Data Hold	•	•	•	•	•	•	•
NCV							
MAX/MIN							
Relative Measurement							
Bar Graph							
Insulation Test	2000MΩ	2000MΩ	2000MΩ				
DC Current (From Plug)							
Low Pass Filter							
Low Impedance							
Dual Display							
Infrared Temperature							
Interface							

DIGITAL CLAMP METERS
AC CURRENT







							
Model	MS2008B	MS2009A	MS2009C	MS2025A	MS2025C	MS2026R	MS2028A
Page	157	158	159	160	161	162	163
Safety Rating	CAT III 600V	CAT III 600V	CAT III 600V	CAT III 1000V CAT IV 600V	CAT III 1000V CAT IV 600V	CAT III 600V	CAT III 600V
Display Counts	4000	2000	6000	6000	6600	6000	2000
Jaw Size	Φ26mm 1.0"	Φ26mm 1.0"	Φ26mm 1.0"	Φ40mm 1.6"	Φ40mm 1.6"	Φ40mm 1.6"	Φ26mm 1.0"
Auto Ranging	•	•	•	•	•	•	•
Auto Power Off	•	•	•	•	•	•	•
True RMS				•	•	•	•
DC Voltage	600V	600V	600V	1000V	1000V	1000V	600V
AC Voltage	600V	600V	600V	750V	750V	750V	600V
DC Current							
AC Current	600A	600A	600A	10A	1000A	1000A	600A
Resistance	40MΩ	20MΩ	60MΩ	60MΩ	66MΩ	60MΩ	20MΩ
Capacitance	100μF		60mF	100mF	66mF	4000μF	
Frequency	100kHz		1kHz	10kHz	66MHz	10kHz	
Duty Cycle	•		•	•	•	•	
Type K Temperature	-20~750°C		-20~1000°C -4~1832°F		-20~1000°C -4~1832°F		
Diode	•	•	•	•	•	•	•
Continuity	•	•	•	•	•	•	•
Display Backlight	•	•	•	•	•	•	•
Work Light		•	•	•	•	•	
Data Hold	•	•	•	•	•	•	•
NCV		•	•	•	•		
MAX/MIN		MAX		•	•	•	Max
Relative Measurement				•	•	•	
Bar Graph					•		
Insulation Test							
DC Current (From Plug)							
Low Pass Filter							
Low Impedance							
Dual Display					•		
Infrared Temperature							
Interface							

DIGITAL CLAMP METERS AC CURRENT

DIGITAL CLAMP METERS AC/DC CURRENT





						
Model	MS2030	MS2030B	MS2033A	MS2101	MS2108	MS2109A
Page	164	165	166	167	168	169
Safety Rating	CAT III 600V	CAT III 600V	CAT III 600V	CAT II 1000V CAT III 600V	CAT III 600V	CAT III 600V
Display Counts	2000	4000	6000	4000	6000	6000
Jaw Size	Φ28mm 1.1"	Φ28mm 1.1"	Φ26mm 1.0"	Φ42mm 1.7"		Φ26mm 1.0"
Auto Ranging		•	•	•	•	•
Auto Power Off		•	•	•	•	•
True RMS					•	
DC Voltage	600V	600V	600V	1000V	600V	600V
AC Voltage	600V	600V	600V	750V	600V	600V
DC Current				1000A	600A	600A
AC Current	400A	600A	600A	1000A	600A	600A
Resistance	2kΩ	40MΩ	10MΩ	40MΩ	66MΩ	60MΩ
Capacitance		100μF		100μF	66mF	MS2109A
Frequency		10kHz	3kHz	100kHz	1kHz	10MHz
Duty Cycle		•	•	•	•	•
Type K Temperature		-20~1000°C -4~1832°F		-40~750°C		-20~1000°C -4~1832°F
Diode	•	•		•	•	•
Continuity	•	•	•	•	•	•
Display Backlight		•	•		•	•
Work Light		•			•	•
Data Hold	•	•	•	•	•	•
NCV		•				•
MAX/MIN			•			•
Relative Measurement				•		•
Bar Graph						
Insulation Test						
DC Current (From Plug)						
Low Pass Filter						
Low Impedance						
Dual Display			•			
Infrared Temperature						
Interface						

DIGITAL CLAMP METERS
AC/DC CURRENT







						
CAT II CAT III CAT IV						
Model	MS2125A	MS2128	MS2128A	MS2138	MS2138R	MS2160
Page	170	171	172	173	174	175
Safety Rating	CAT III 1000V CAT IV 600	CAT III 600V	CAT III 600V	CAT III 600V	CAT III 600V	CAT III 600V
Display Counts	6000	6600	4000	4000	4000	4000
Jaw Size	Φ40mm 1.6"	Φ26mm 1.0"	Φ26mm 1.0"	Φ26mm 1.0"	Φ26mm 1.0"	Φ24mm 0.9"
Auto Ranging	•	•	•	•	•	•
Auto Power Off	•	•	•	•	•	•
True RMS	•	•	•	•	•	•
DC Voltage	1000V	600V	600V	600V	600V	600V
AC Voltage	750V	600V	600V	600V	600V	600V
DC Current	1000A	600A	400A	1000A	1000A	80A
AC Current	1000A	600A	400A	1000A	1000A	80A
Resistance	60MΩ	66MΩ	40MΩ	40MΩ	40MΩ	40MΩ
Capacitance	100mF	66mF	4000μF	4000μF	4000μF	40mF
Frequency	1000Hz	1000Hz	1000Hz	10kHz	10kHz	10kHz
Duty Cycle	•	•	•	•	•	•
Type K Temperature						-20~1000°C -4~1832°F
Diode	•	•	•	•	•	•
Continuity	•	•	•	•	•	•
Display Backlight	•	•	•	•	•	•
Work Light	•	•	•	•	•	•
Data Hold	•	•	•	•	•	•
NCV	•					•
MAX/MIN	•	•	•			
Relative Measurement	•		•	•	•	
Bar Graph			•	•	•	
Insulation Test						
DC Current (From Plug)						
Low Pass Filter						
Low Impedance						
Dual Display						
Infrared Temperature						
Interface						

DIGITAL CLAMP METERS LEAKGE



DIGITAL CLAMP METERS POWER

				
	CAT II CAT III CAT IV			
Model	MS2006B	MS2203	MS2205	MS2225A
Page	176	177	178	179
Safety Rating	CAT III 600V	CAT III 600V	CAT III 600V	CAT III 1000V CAT IV 600V
Display Counts	2000	9999	6000	6000
Jaw Size	Φ31mm 1.2"	Φ50mm 2.0"	Φ50mm 2.0"	Φ40mm 1.6"
Auto Ranging		•	•	•
Auto Power Off	•		•	•
True RMS		•	•	•
DC Voltage				1000V
AC Voltage		600V	600V	750V
DC Current				
AC Current	60A	1000A	1000A	1000A
Resistance				60MΩ
Capacitance				100mF
Frequency		1000Hz	1000Hz	10kHz
Duty Cycle				•
Type K Temperature				
Diode				•
Continuity				•
Display Backlight		•	•	•
Work Light				•
Data Hold	•	•	•	•
NCV				•
MAX/MIN		•		•
Relative Measurement				•
Bar Graph		•		
Active Power		600kW	600kW	750kW
Apparent Power		600kVA	600kVA	750kVA
Reactive Power		600kVAr	600kVAr	750kVAr
Power Factor		0.3~1	0.3~1	0.3~1
Active Energy		9999kWh		
Harmonic Measurement			45~65Hz	45~65Hz
Data Logging		28 Groups	100 Groups	
Interface		RS232	RS232	Wireless

DIGITAL CLAMP METERS
SPECIAL APPLICATION

						
CAT II CAT III CAT IV						
Model	M9912	MS2015A	MS2600	MS2601	MS3300	MS3302
Page	180	181	182	183	184	185
Safety Rating	CAT II 1000V	CAT III 1000V CAT IV 600V	CAT III 600V	CAT III 600V	CAT II 1000V	CAT II 600V
Display Counts	3200	6000	4000	6000		
Jaw Size	Φ55mm 2.2"	Φ40mm 1.6"	Φ12mm 0.5"	Φ12mm 0.5"	Φ55mm 2.2"	Φ28mm 1.1"
Auto Ranging	•	•	•	•		
Auto Power Off			•	•		
True RMS		•			•	
DC Voltage	750V	1000V	1000V	600V		
AC Voltage	750V	750V	700V	600V		
DC Current	1000A				1000A	
AC Current	1000A	1000A	200A	200A	1000A	400A
Inrush Current						
Resistance	30MΩ	60MΩ	40MΩ	60MΩ		
Capacitance		100mF	40μF	60mF		
Frequency	30kHz	10MHz	100kHz	60MHz		
Duty Cycle		•	•	•		
Type K Temperature					-20~400°C -4~750°F	
Diode	•	•	•	•		
Continuity	•	•	•	•		
Display Backlight	•	•	•	•		
Work Light	•	•		•		
Data Hold	•	•	•	•		
NCV		•		•		
MAX/MIN		•				
Relative Measurement			•			
Bar Graph						
Insulation Test						
DC Current (From Plug)				1000μA		
Low Pass Filter						
Low Impedance				•		
Dual Display						
Infrared Temperature						
Interface						





LINE SPLITTERS

			
	CAT II CAT III CAT IV		
Model	MS922A	MS922D	MS922E
Page	187	188	189
Safety Rating	CAT II 600V	CAT II 600V	CAT II 600V
AC Voltage	125V	250V	250V
AC Current	15A	15A	15A
Frequency	50~60Hz	50~60Hz	50~60Hz
Feature	-Allows for easy AC Current measurements -Using a Clamp meter on 2 or 3 Wire Power Cords -Provides the Ability to Safely Measure Current without the need to cut or separate conductors -Separates the Hot/Live conductor from the Neutral and Ground -Voltage check sockets for easy power calculations		
Style	USA	EU	UK





ELECTRICAL TESTERS

					
	CAT II CAT III CAT IV				
Model	MS6580B	MS8900	MS8900A	MS8900C	MS8902A
Page	191	192	193	194	195
Safety Rating	CAT II 1000V CAT III 600V	CAT II 1000V CAT III 600V	CAT II 1000V CAT III 600V	CAT II 1000V CAT III 600V	CAT II 1000V CAT III 600V
Non Contact Voltage	12~1000V	100~240V	90~1000V	100~240V	12~1000V
Contact Voltage					
Frequency	50~60Hz	50~60Hz	50~60Hz	50~60Hz	50~500Hz
Metal Detecting					
RCD Test					
Work Light	•				
Sound & Light	•	•	•	•	•
Auto Power Off	•				•
Sensitivity adjustment	•				•
Infrared temperature	-20~330°C -4~626°F				

ELECTRICAL TESTERS

				
	CAT II CAT III CAT IV			
Model	MS8902B	MS8907	MS8922A	MS8922B
Page	196	197	198	199
Safety Rating	CAT II 1000V CAT III 600V	CAT II 1000V CAT III 600V	CAT III 400V	CAT III 400V
Non Contact Voltage	20~1000V	50~1000V		
Contact Voltage			400V	400V
Frequency	50~500Hz	50~60Hz	50~60Hz	50~60Hz
Metal Detecting	<20mm			
RCD Test				•
Work Light		•		
Sound & Light	•	•		
Auto Power Off	•			
Sensitivity adjustment	•			

CIRCUIT TESTERS

					
	CAT II CAT III CAT IV				
Model	MS102	MS112	MS5902RT	MS5905RT	MS6860
Page	201	202	203	204	205
Safety Rating	CAT II 125V	CAT II 125V	CAT II 600V	CAT II 600V	CAT II 230V
AC Voltage	125V	125V	230V/120V	230V	230V
Socket Test	•	•	•	•	•
GFCI Test	•		TF type	TF type	
RCD Test					
Work Light			•		
NCV				•	
Buzzer & LED Instruction	•	•	•	•	•





CIRCUIT ANALYZERS

				
CAT II CAT III CAT IV				
Model	MS5900	MS5901	MS5908A	MS5908C
Page	207	208	209	210
Safety Rating	CAT III 600V	CAT III 600V	CAT III 300V	CAT III 300V
AC Voltage	400V	400V	190V	375V
Frequency	400Hz	400Hz	45~65Hz	45~65Hz
Motor & Phase Rotation Indicator	•	•		
Voltage Drop Current			12/15/20A	12/15/20A
Impedance measurement			>3.00Ω	>3.00Ω
GFCI Test			•	•
RCD Test			•	•
Data Hold			•	•
Backlight			•	•





WIRE & CABLE TESTERS

					
CAT II CAT III CAT IV					
Model	MS6810	MS6811	MS6812A	MS6813	MS6818
Page	212	213	214	215	216
Safety Rating					CAT III 300V
Auto Ranging					•
DC Voltage					12~400V
AC Voltage					12~400V
Frequency			300kHz	300kHz	125kHz
Low Battery Indicator		•			
Sensitivity Adjustable			•	•	•
Electric Wire			•	•	•
Coaxial Cable (BNC)	•			•	
Network Cable	•	•		•	
Telephone Wire			•	•	
Backlight					•
Worklight					•
Sound & light instructions			•	•	•



LCR METERS

					
Model	MS5308	MS6013	MS8910	MS8911	MY6243
Page	218	219	220	221	222
Auto Ranging			•	•	
Auto Power Off			•	•	
Resistance	2Ω/200MΩ		300Ω/30MΩ	60Ω/20MΩ	
Capacitance	2000pF/2000μF	200pF/20mF	3nF/30mF	600pF/6mF	2nF/200μF
Inductance	2000μH~2000H			600μH/200H	2mH~2H
Diode			•		
Continuity Buzzer			•		
Auto Scanning			•	•	
Zero Adjustment		•			
LCR/DCR	•			•	
Data Hold	•		•	•	
Backlight	•				
Relative Measurement	•				
Interface	RS232				







EARTH RESISTANCE

					
	CAT II CAT III CAT IV				
Model	MS2115A	MS2301	MS2302	MS2306	MS2308
Page	224	225	226	227	228
Safety Rating	CAT III 1000V CAT IV 600V	CAT III 150V	CAT III 300V		
Resistance	60MΩ	1200Ω	4000Ω	20kΩ	20kΩ
Measurement Voltage	AC 750V DC 1000V		AC 200V	AC 20V/48V DC 20V	AC 20V/48V DC 20V
Sensing & Inducing Current Transformer					•
Back light	•		•	•	•
Interface					USB

INSULATION TESTERS

					
CAT II CAT III CAT IV					
Model	MS5201	MS5202	MS5203	MS5205	MS5215
Page	230	231	232	233	234
Safety Rating	CAT II 1000V CAT III 600V	CAT II 1000V	CAT III 1000V CAT IV 600V	CAT III 1000V CAT IV 600V	CAT III 1000V CAT IV 600V
Insulation Resistance	0.01MΩ~2GΩ	0.01MΩ~100GΩ	0.01MΩ~10GΩ	0.01MΩ~10GΩ	0.01MΩ~5TΩ
Output Voltage	1kV DC	2.5kV DC	1kV DC	2.5kV DC	5kV DC
Leakage Current test					1nA~3mA
Continuity Test	<50Ω		0.01Ω~200Ω (1mA)	0.01Ω~200Ω (1mA)	
Measurement Voltage	DC 1000V AC 700V	AC 5000V	DC 1000V AC 700V	DC 1000V AC 700V	DC 1000V AC 750V
Short Current	1.8mA		1.8mA	3mA	3mA
Temperature Test					-10~70°C
Back Light			•	•	•
Interface					USB

DIGITAL THERMOMETERS

						
Model	MS6500	MS6505	MS6511	MS6512	MS6513	MS6514
Page	236	237	238	239	240	241
Thermocouple Type	K		K.J.T.E	K.J.T.E	K.J.T.E. R.S.N	K.J.T.E. R.S.N
Temperature	-50~750°C -58~1382°F	-20~60°C -4~140°F	-200~1372°C -328~2501°F	-200~1372°C -328~2501°F	-200~1372°C -328~2501°F	-200~1372°C -328~2501°F
Injection Method	Single		Single	Dual	Single	Dual
Channel			TC	T1/T2/T1-T2	TC	T1/T2/T1-T2
Relative Humidity		0~100%				
Update Rate	500mS					
Clock		•				
MAX/MIN/AVG/DIF		MAX/MIN	•	•	•	•
Date Logging		16300 groups			1000 groups	1000 groups
Backlight		•				
Date Hold	•	•	•	•	•	•
Interface		RS232			USB	USB

INFRARED THERMOMETERS



Model	MS6522A	MS6522B	MS6531B	MS6531C	MS6541
Page	242	243	244	245	246
Color Display			•	•	•
IRT Temperature	-20~300°C -4~572°F	-20~500°C -4~932°F	-40~800°C -40~1472°F	-40~800°C -40~1472°F	-50~760°C -58~1400°F
Type K Temperature				-40~1080°C -40~1976°F	-50~300°C -58~572°F
Distance to Spot(D:S)	10:1	10:1	12:1	12:1	30:1
Emissivity	0.95	0.95	0.1~0.99	0.1~0.99	0.1~0.99
MAX/MIN/AVG/DIF	MAX/MIN/AVG	MAX/MIN/AVG	•	•	•
Data Logging				20 groups	100 groups
Backlight	•	•	•	•	•
Data hold	•	•	•	•	•

SOUND METERS



Model	MS6700	MS6701	MS6708
Page	248	249	250
Display	2000	2000	2000
Auto Ranging	•	•	•
Auto Power Off	•	•	•
Sound Level	30~130dB	30~130dB	30~130dB
Dynamic	50dB	50dB	50dB
Frequency	31.5Hz~8kHz	31.5Hz~8kHz	30Hz~8kHz
A/C Weighting	•	•	•
Data Logging		16000	
Data Hold			•
Date/Time	•	•	
Backlight	•	•	•
MAX	•	•	•
AC adapter	•	•	
AC/DC Signal output	•	•	
Interface		USB	

ANEMOMETERS



Model	MS6252A	MS6252B	MS6252D
Page	251	252	253
m/s	0.8~40 m/s	0.8~40 m/s	0.8~40 m/s
km/h	2.88~144 km/h	2.88~144 km/h	2.88~144 km/h
ft/s	2.62~131.2 ft/s	2.62~131.2 ft/s	2.62~131.2 ft/s
Knots	1.6~77.70 Knots	1.6~77.70 Knots	1.6~77.70 Knots
mile/h	1.8~90.00 mile/h	1.8~90.00 mile/h	1.8~90.00 mile/h
ft/m	157.5~7874 ft/m	157.5~7874 ft/m	157.5~7874 ft/m
Temperature		-10~60°C	-10~60°C
Relative Humidity		20~80%RH	20~80%RH
Ambient		•	•
Dew point		•	•
Wet Bulb		•	•
Interface		USB	Wireless

LIGHT METERS



Model	MS6610	MS6612	MS6612B	MS6612D
Page	254	255	256	257
Auto Ranging		•	•	•
Auto Power Off		•	•	•
Display Counts	2000	2000	2000	2000
Ranging	0~50000Lux	0~200000Lux 0~20000FC	0~200000Lux 0~20000FC 0~999900CD	0~200000Lux 0~20000FC 0~999900CD
Unit Selection	Lux	Lux/FC	Lux/FC/CD	Lux/FC/CD
Relative		•	•	•
Peak		•	•	•
MAX/MIN		•	•	•
Data Hold	•	•	•	•
Bar Graph		•	•	•
LED light source			•	•
Interface				Wireless

MOISTURE METERS



Model	MS6900	MS6900A
Page	258	259
Ranging	Wood , Brick, Plaster ...	Wood , Brick, Plaster ...
Testing Depth	5mm	5mm
Object moisture	0~60%	0~60%
Ambient TEMP	-10~50°C 14~122°F	-10~50°C 14~122°F
Sampling Rate	240mS	240mS
MAX/MIN	•	•
Unit Selection	WB, TD, °C, °F, %RH	WB, TD, °C, °F, %RH
Auxiliary Verification		•
Data Hold	•	•
Backlight	•	•

TACHOMETERS



Model	MS6208A	MS6208B
Page	260	261
Contact	50~19999	
Measurement	50~19999RPM	50~99999RPM (Non-Contact)
Measuring Distance	X	50~250mm
Auto Power Off	•	•
MAX/MIN	•	•
Data Hold	•	•
Backlight	•	•
Unit Selection	•	
Data Logging	100 Groups	100 Groups

GAS DETECTOR



Model	MS6310
Page	262
Alarm at level	10%~40%
Response Time	2 seconds
Warm up time	2 Minutes
Easy to Identify	•
Pinpoint Gas Leaks	•
Portable	•
High Sensitivity	•
Resume Original measurement	State after 7~10 min in clear air
Gas Detected	Natural gas, Methance, Ethane, Propane

ENVIRONMENT TESTER



Model	MS6300
Page	263
Auto Ranging	•
Auto Power Off	•
Temperature	-10~60°C/14~140°F
Humidity	20~80%RH
Sound level	30~130dB
luminance	x100 (50000)
Wind Speed	0.5~20m/s, 1.8~72km/h 100~4000FPM, 0.9~38.9Knots
AirFlow [CMM]	0~999900
AirFlow [CFM]	0~999900
A/C Weighting	•
MAX/MIN/AVG/DIF	•
Data Hold	•
Backlight	•

STUD METAL DETECTOR



Model	MS6906
Page	264
Auto Power Off	7 Minute
Wooden Pillar	30mm
Metal Stud Detection Detph	30mm
Metal Pipe Detector Depth	50mm
AC Voltage Detection Detph	75mm (50~600VAC)
Data Hold	•
Backlight	•

PROCESS CALIBRATOR



Model	MS7221
Page	265
DC Volatge	10V
DC Current	10A
Loop Power Output	24V DC

NEW PRODUCT

DIGITAL MULTIMETER | DIGITAL CLAMP METERS
ENVIRONMENTAL TESTERS





DIGITAL MULTIMETER
MS830M

SKU NO.: MS830MCBGL0
EAN CODE: 8435394788272

FEATURE

- Frequency: 400Hz
- Diode Test
- Continuity Check
- Unit Display

SPECIFICATIONS

AC Voltage 600V	DC Voltage 600V	DC Current 10A
Resistance 200MΩ	Display Counts 2000	

MAIN APPLICATIONS

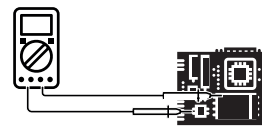
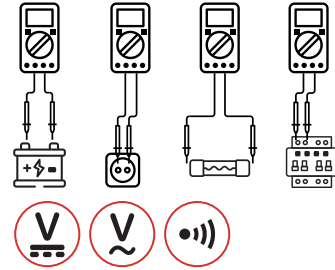

CONTENTS



133x71x47mm
5.2"x2.8"x1.8"
190g/0.42lb



1.5V AAA*2



Test Leads
Battery



Calibration
Certificate

ACCESSORIES



Quick Start
Guide

PACKAGING INFORMATION



Color Box
L112xW54xH155mm



Carton Box
57x33.5x25cm



X 40PCS



DIGITAL MULTIMETER - TRUE RMS
MS830T

SKU NO.: MS830TCBGLO
EAN CODE: 8435394788289

FEATURE

- Frequency: 400Hz
- Diode Test
- Continuity Check
- Unit Display

SPECIFICATIONS

AC Voltage 600V	DC Voltage 600V	DC Current 10A
AC Current 10A	Resistance 200MΩ	Display Counts 2000
Capacitance 200uF	Temperature -20°C~1000°C	Frequency 2KHz

MAIN APPLICATIONS



DOMESTIC

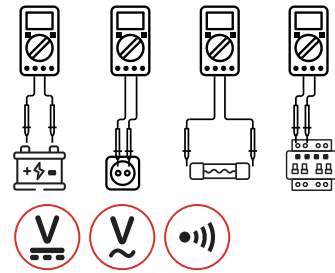

ELECTRONICS

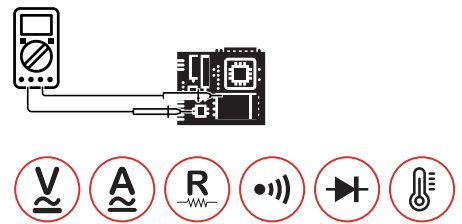

CONTENTS



133x71x47mm
5.2"x2.8"x1.8"
190g/0.42lb



1.5V AAA*2



ACCESSORIES

Test Leads
Temperature probe
Battery



Calibration
Certificate



Quick Start
Guide

PACKAGING INFORMATION



Color Box
L112xW54xH155mm



Carton Box
57x33.5x25cm



X 40PCS



DIGITAL MULTIMETER

MS830N

SKU NO.: MS830NCBGLO
EAN CODE: 8435394788296

FEATURE

- Frequency: 400Hz
- Diode Test
- Continuity Check
- Unit Display

SPECIFICATIONS

AC Voltage 600V	DC Voltage 600V	DC Current 10A
Resistance 200MΩ	Display Counts 2000	

MAIN APPLICATIONS

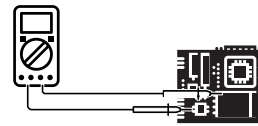
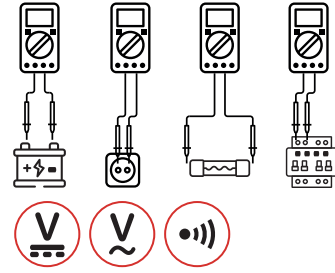

CONTENTS



133x71x47mm
5.2"x2.8"x1.8"
190g/0.42lb



1.5V AAA*2



Test Leads
Battery



Calibration
Certificate

ACCESSORIES



Quick Start
Guide

PACKAGING INFORMATION



Color Box
L112xW54xH155mm



Carton Box
57x33.5x25cm



X 40PCS



DIGITAL MULTIMETER - TRUE RMS
MS850A

SKU NO.: MS850ACBGLO
EAN CODE: 8435394788302

FEATURE

- Frequency: 400Hz
- Diode Test
- Continuity Check
- Unit Display

SPECIFICATIONS

AC Voltage 600V	DC Voltage 600V	DC Current 10A
AC Current 10A	Resistance 200MΩ	Display Counts 2000

MAIN APPLICATIONS

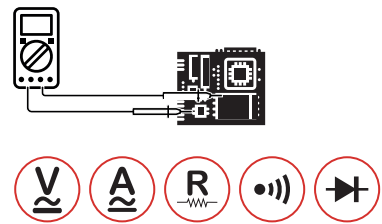
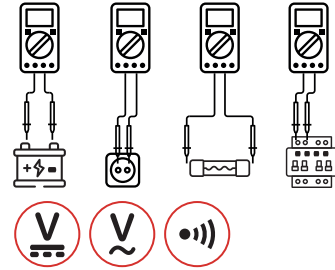

CONTENTS



150x75x47mm
5.9"x2.9"x1.8"
284g/0.63lb



1.5V AAA*2



Test Leads
Battery



Calibration
Certificate

ACCESSORIES



Quick Start
Guide

PACKAGING INFORMATION



Color Box
L112xW54xH155mm



Carton Box
57x33.5x25cm



X 40PCS



DIGITAL MULTIMETER - TRUE RMS
MS850B

SKU NO.: MS850BCBGLO
 EAN CODE: 8435394788524

FEATURE

- Buzzer / Continuity / Diode
- MAX / MIN / True RMS / REL
- Non-Contact Voltage (NCV) Detection
- Live Wire(Live) Recognition

SPECIFICATIONS

AC Voltage 600V	DC Voltage 600V	AC Current 10A
Temperature -20°C~1000°C	Resistance 20MΩ	Display Counts 2000

MAIN APPLICATIONS

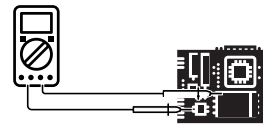
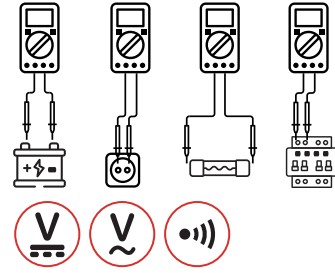

CONTENTS



150x75x47mm
 5.9"x2.9"x1.8"
 284g/0.63lb



1.5V AAA*2



ACCESSORIES

Test Leads
 Temperature probe
 Battery



Calibration Certificate



Quick Start Guide

PACKAGING INFORMATION



Color Box
 L112xW54xH155mm



Carton Box
 57x33.5x25cm



X 40PCS



DIGITAL MULTIMETER - TRUE RMS
MS850C

SKU NO.: MS850CCBGL0
EAN CODE: 8435394788531

FEATURE

- Buzzer / Continuity / Diode
- MAX / MIN / True RMS / REL
- Non-Contact Voltage (NCV) Detection
- Live Wire(Live) Recognition

SPECIFICATIONS

AC Voltage 600V	DC Voltage 600V	DC Current 10A
AC Current 10A	Frequency 10MHz	Capacitance 100mF
Display Counts 4000		

MAIN APPLICATIONS

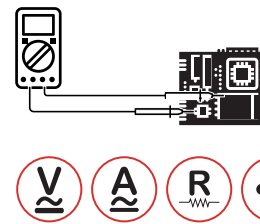
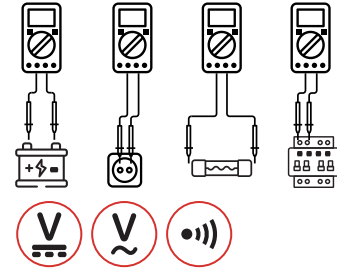

CONTENTS



150x75x47mm
5.9"x2.9"x1.8"
284g/0.63lb



1.5V AAA*2



ACCESSORIES

Test Leads
Temperature probe
Battery



Calibration
Certificate



Quick Start
Guide

PACKAGING INFORMATION



Color Box
L112xW54xH155mm



Carton Box
57x33.5x25cm



X 40PCS



DIGITAL MULTIMETER - TRUE RMS
MS850D

SKU NO.: MS850CCBGLO
EAN CODE: 8435394788531

FEATURE

- Buzzer / Continuity / Diode
- MAX / MIN / True RMS / REL
- Non-Contact Voltage (NCV) Detection
- Live Wire(Live) Recognition

SPECIFICATIONS

AC Voltage 600V	DC Voltage 600V	DC Current 10A
AC Current 10A	Frequency 10MHz	Capacitance 100mF
Display Counts 4000	Temperature -20°C~1000°C	

MAIN APPLICATIONS

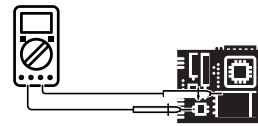
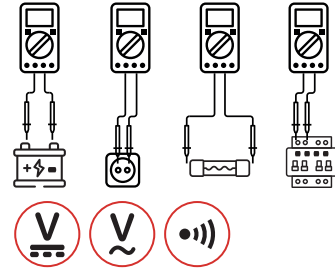

CONTENTS



150x75x47mm
5.9"x2.9"x1.8"
284g/0.63lb



1.5V AAA*2



Test Leads
Temperature probe
Battery



Calibration Certificate



Quick Start Guide

PACKAGING INFORMATION



Color Box
L112xW54xH155mm



Carton Box
57x33.5x25cm



X 40PCS



DIGITAL MULTIMETER - TRUE RMS
MS8239D+

SKU NO.: MS8239D+CBGLO
EAN CODE: 8435394788319

FEATURE

- Frequency: 1000Hz
- Overload Protection
- True RMS
- Non-Contact Voltage (NCV) Detection

SPECIFICATIONS

AC Voltage 600V	DC Voltage 600V	DC Current 10A
AC Current 10A	Resistance 40MΩ	Capacitance 40.00mF
Frequency 10MHz	Display Counts 2000	

MAIN APPLICATIONS



DOMESTIC

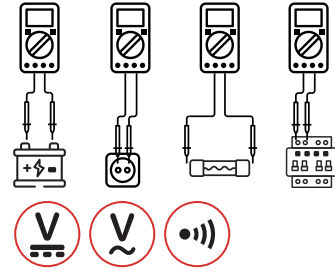

ELECTRONICS

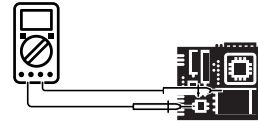

CONTENTS



147x74x46mm
5.8"x2.9"x1.8"
229g/0.50lb



1.5V AAA*2



Test Leads
Battery



Calibration
Certificate

ACCESSORIES



Quick Start
Guide

PACKAGING INFORMATION



Color Box
L112xW54xH155mm



Carton Box
57x33.5x25cm



X 40PCS



DIGITAL MULTIMETER - TRUE RMS
MS8239T

SKU NO.: MS8239TCBGLO
EAN CODE: 8435394788326

FEATURE

- Frequency: 1000Hz
- Overload Protection
- True RMS
- Non-Contact Voltage (NCV) Detection

SPECIFICATIONS

AC Voltage 600V	DC Voltage 600V	DC Current 10A
AC Current 10A	Resistance 40MΩ	Capacitance 40.00mF
Frequency 10MHz	Display Counts 2000	Temperature -20°C~750°C

MAIN APPLICATIONS

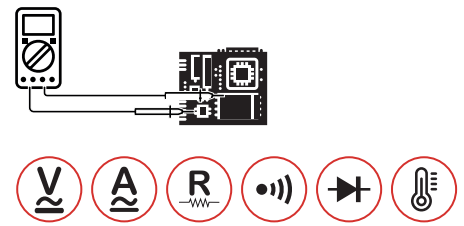
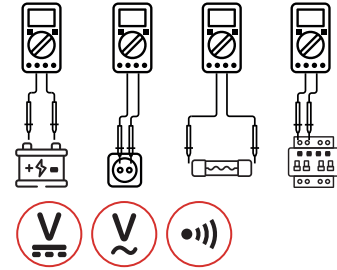

CONTENTS



147x74x46mm
5.8"x2.9"x1.8"
229g/0.50lb



1.5V AAA*2



ACCESSORIES

Test Leads
Temperature probe
Battery



Calibration
Certificate



Quick Start
Guide

PACKAGING INFORMATION



Color Box
L112xW54xH155mm



Carton Box
57x33.5x25cm



X 40PCS



DIGITAL MULTIMETER - TRUE RMS
MS890A

SKU NO.: MS890ACBGLO
EAN CODE: 8435394788333

FEATURE

- True RMS
- Overload Protection
- Transistor Test
- Diode / Continuity

SPECIFICATIONS

AC Voltage 750V	DC Voltage 1000V	DC Current 10A
AC Current 10A	Resistance 200MΩ	Capacitance 200uF
Frequency 200KHz	Display Counts 2000	

MAIN APPLICATIONS

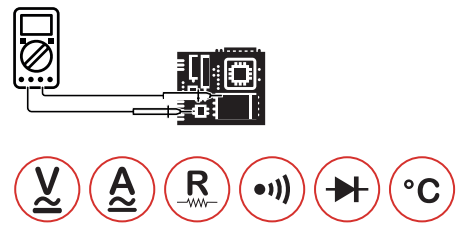
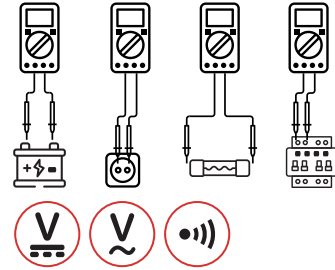

CONTENTS



185x88x54mm
7.3"x3.5"x2.1"
355g/0.78lb



9V 6F22 Battery



ACCESSORIES

Test leads
Temperature probe
Battery



Calibration
Certificate



Quick Start
Guide

PACKAGING INFORMATION



Color Box
L118xW58xH195mm



Carton Box
42x32.5x26cm



X 20PCS



DIGITAL MULTIMETER - TRUE RMS
MS890B

SKU NO.: MS890BCBGLO
EAN CODE: 8435394788340

FEATURE

- Overload Protection
- Transistor Test / Diode / Continuity / LED
- Non-Contact Voltage (NCV) Detection
- Live Wire(Live) Recognition

SPECIFICATIONS

AC Voltage 750V	DC Voltage 1000V	DC Current 20A
AC Current 20A	Resistance 40MΩ	Capacitance 40mF
Frequency 1KHz	Display Counts 4000	

MAIN APPLICATIONS

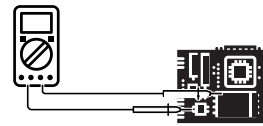
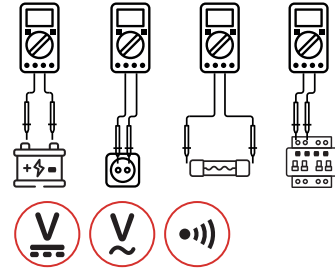

CONTENTS



185x88x54mm
7.3"x3.5"x2.1"
355g/0.78lb



1.5V AA*2



Test leads
Battery



Calibration
Certificate

ACCESSORIES



Quick Start
Guide

PACKAGING INFORMATION



Color Box
L118xW58xH195mm



Carton Box
42x32.5x26cm



X 20PCS



DIGITAL MULTIMETER - TRUE RMS
MS890C+

SKU NO.: MS890C+CBGLO
EAN CODE: 8435394788357

FEATURE

- Duty Cycle / Square Wave Output
- Overload Protection / Diode / Continuity
- Non-Contact Voltage (NCV) Detection
- Live Wire(Live) Recognition

SPECIFICATIONS

AC Voltage 750V	DC Voltage 1000V	DC Current 10A
AC Current 10A	Resistance 60MΩ	Capacitance 60mF
Frequency 10MHz	Display Counts 6000	Temperature -20°C~1000°C

MAIN APPLICATIONS

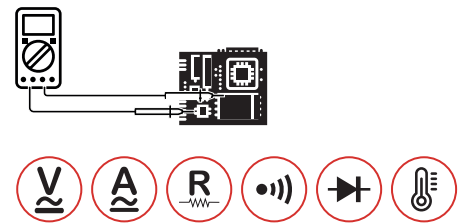
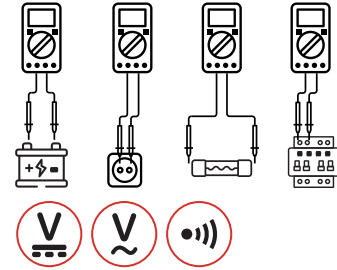

CONTENTS



185x88x54mm
7.3"x3.5"x2.1"
355g/0.78lb



1.5V AA*2



ACCESSORIES

Test Leads
Temperature probe
Battery



Calibration
Certificate



Quick Start
Guide

PACKAGING INFORMATION



Color Box
L118xW58xH195mm



Carton Box
42x32.5x26cm



X 20PCS



DIGITAL MULTIMETER - TRUE RMS
MS890D+

SKU NO.: MS890D+CBGLO
EAN CODE: 8435394788364

FEATURE

- True RMS
- Auto Power Off / Data Hold
- Non-Contact Voltage (NCV) Detection
- Live Wire(Live) Recognition

SPECIFICATIONS

AC Voltage 750V	DC Voltage 1000V	DC Current 20A
AC Current 20A	Resistance 40MΩ	Capacitance 40mF
Frequency 1KHz	Display Counts 4000	Temperature -20°C~1000°C

MAIN APPLICATIONS

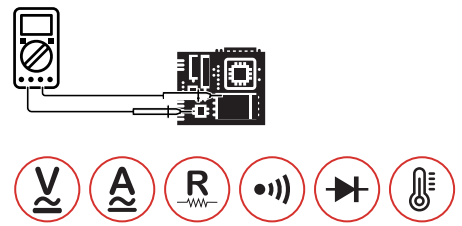
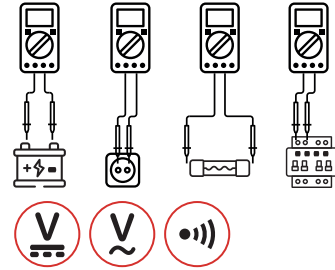

CONTENTS



185x88x54mm
7.3"x3.5"x2.1"
355g/0.78lb



1.5V AA*2



ACCESSORIES

Test Leads
Temperature probe
Battery



Calibration Certificate



Quick Start Guide

PACKAGING INFORMATION



Color Box
L118xW58xH195mm



Carton Box
42x32.5x26cm



X 20PCS



DIGITAL CLAMP METER - TRUE RMS
MS2003A

SKU NO.: MS2003ACBGLO
EAN CODE: 8435394788388

FEATURE

- True RMS / Relative
- MAX / MIN / Diode / Continuity
- Non-Contact Voltage (NCV) Detection
- Live Wire(Live) Recognition

SPECIFICATIONS

AC Voltage 600V	DC Voltage 600V	AC Current 200A
Resistance 40MΩ	Capacitance 4mF	Frequency 10MHz
Jaw Opening 19mm	Display Counts 4000	Temperature -20°C~1000°C

MAIN APPLICATIONS

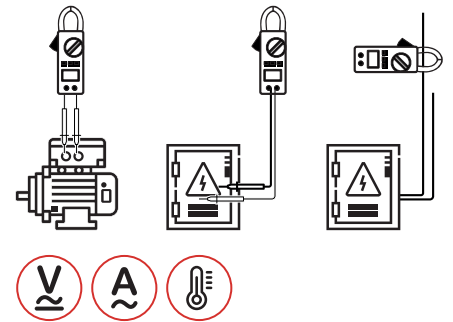
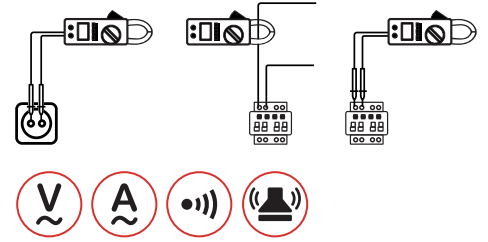

CONTENTS



60x32x178mm
2.4"×1.3"×7.0"
165g/0.36lb



1.5V AAA*2



ACCESSORIES

Carry bag
Test Leads
Temperature probe
Battery



Calibration Certificate



Quick Start Guide

PACKAGING INFORMATION



Color Box
L75×W55×H195mm



Carton Box
58×32.5×22cm



X 40PCS



DIGITAL CLAMP METER - TRUE RMS
MS2003B

SKU NO.: MS2003BCBGLO
 EAN CODE: 8435394788371

FEATURE

- True RMS / Relative
- MAX / MIN / Diode / Continuity
- Non-Contact Voltage (NCV) Detection
- Live Wire(Live) Recognition

SPECIFICATIONS

AC Voltage 600V	DC Voltage 600V	AC Current 200A
Resistance 60MΩ	Capacitance 60mF	Frequency 10MHz
Jaw Opening 19mm	Display Counts 6000	Temperature -20°C~1000°C

MAIN APPLICATIONS

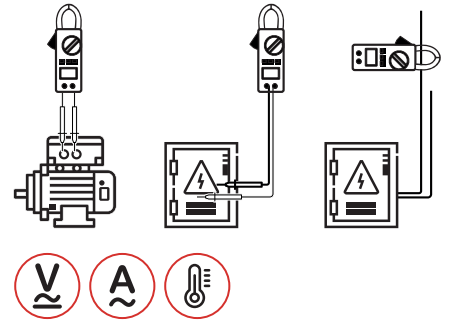
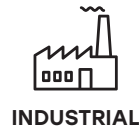
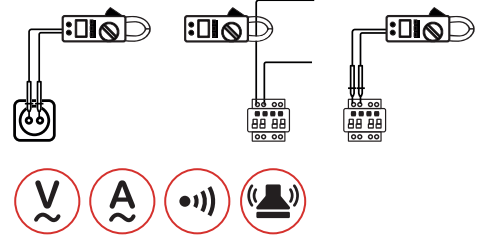

CONTENTS



60x32x178mm
 2.4"×1.3"×7.0"
 165g/0.36lb



1.5V AAA*2



ACCESSORIES

Carry bag
 Test Leads
 Temperature probe
 Battery



Calibration Certificate



Quick Start Guide

PACKAGING INFORMATION



Color Box
 L75×W55×H195mm



Carton Box
 58×32.5×22cm



X 40PCS



DIGITAL CLAMP METER - TRUE RMS
MS2103A

SKU NO.: MS2103ACBGLO
EAN CODE: 8435394788395

FEATURE

- True RMS / Relative / Diode / Continuity
- 600mA Fuse
- Non-Contact Voltage (NCV) Detection
- Live Wire(Live) Recognition

SPECIFICATIONS

AC Voltage 600V	DC Voltage 600V	AC Current 200A
Resistance 60MΩ	Capacitance 60mF	Frequency 1MHz
Jaw Opening 19mm	Display Counts 6000	

MAIN APPLICATIONS

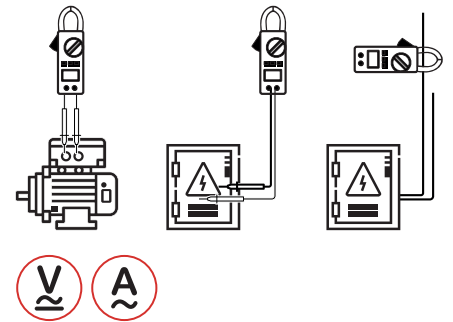
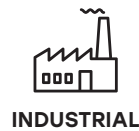
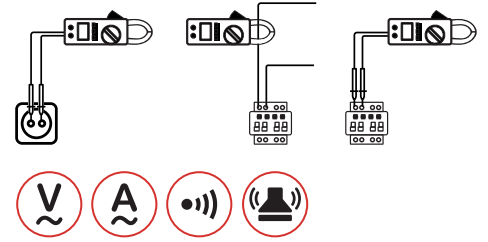

CONTENTS



60x32x178mm
2.4" x 1.3" x 7.0"
165g/0.36lb



1.5V AAA*2



Carry bag
Test Leads
Temperature probe
Battery



Calibration Certificate



Quick Start Guide

PACKAGING INFORMATION



Color Box
L75xW55xH195mm



Carton Box
58x32.5x22cm



X 40PCS



DIGITAL CLAMP METER - TRUE RMS
MS2103B

SKU NO.: MS2103BCBGLO
 EAN CODE: 8435394788401

FEATURE

- True RMS / Relative / Diode / Continuity
- MAX / MIN
- Non-Contact Voltage (NCV) Detection
- Live Wire(Live) Recognition

SPECIFICATIONS

AC Voltage 600V	DC Voltage 600V	AC Current 200A
DC Current 200A	Resistance 40MΩ	Capacitance 4mF
Frequency 10MHz	Jaw Opening 19mm	Display Counts 6000
Temperature -20°C~1000°C		

MAIN APPLICATIONS

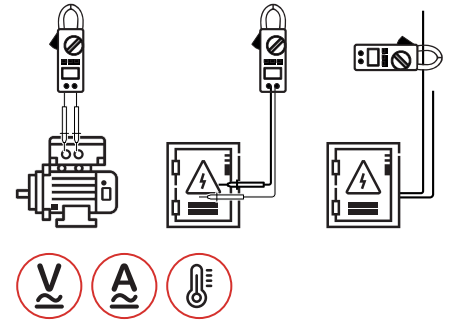
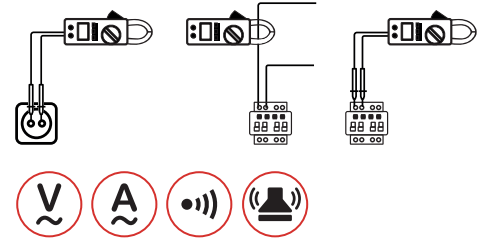

CONTENTS



60x32x178mm
 2.4" x 1.3" x 7.0"
 165g/0.36lb



1.5V AAA*2



ACCESSORIES

- Carry bag
- Test Leads
- Temperature probe
- Battery



Calibration Certificate



Quick Start Guide

PACKAGING INFORMATION



Color Box
 L75xW55xH195mm



Carton Box
 58x32.5x22cm



X 40PCS



DIGITAL CLAMP METER
MS2109B

SKU NO.: MS2109BCBGLO
EAN CODE: 8435394788418

FEATURE

- LED / Flashlight / LPF(ACV)
- Overload Protection
- Non-Contact Voltage (NCV) Detection
- Live Wire(Live) Recognition

SPECIFICATIONS

AC Voltage 600V	DC Voltage 600V	AC Current 600A
Resistance 20MΩ	Frequency 60Hz	Jaw Opening 23mm
Display Counts 2000		

MAIN APPLICATIONS

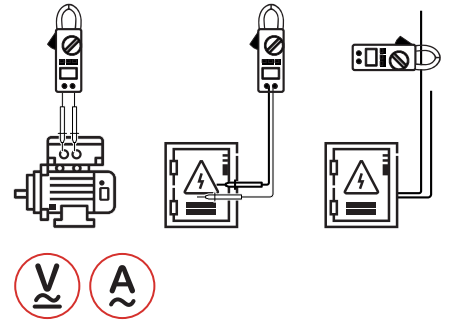
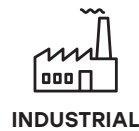
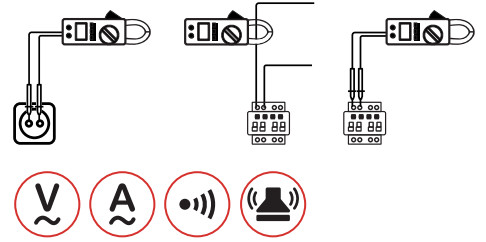

CONTENTS



72x35x194mm
2.8"×1.4"×7.6"
320g/0.7lb



1.5V AAA*3



ACCESSORIES

Carry bag
Test Leads
Temperature probe
Battery



Calibration Certificate



Quick Start Guide

PACKAGING INFORMATION



Color Box
L146×W45×H225mm



Carton Box
50×31.5×25cm



X 20PCS



DIGITAL CLAMP METER - TRUE RMS
MS2109C

SKU NO.: MS2109CCBGLO
 EAN CODE: 8435394788425

FEATURE

- True RMS / Relative / LED / Flashlight
- Overload Protection
- Non-Contact Voltage (NCV) Detection
- Live Wire(Live) Recognition

SPECIFICATIONS

AC Voltage 600V	DC Voltage 600V	AC Current 600A
Resistance 40MΩ	Frequency 10MHz	Capacitance 10mF
Jaw Opening 23mm	Display Counts 4000	Temperature -20°C~1000°C

MAIN APPLICATIONS

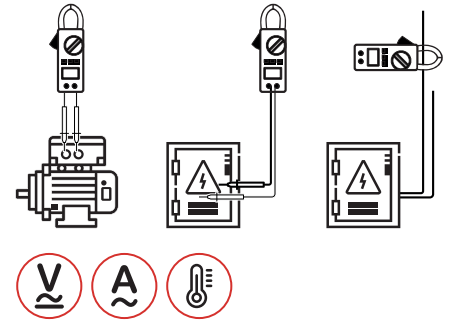
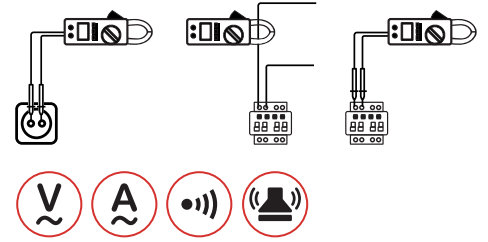

CONTENTS



72x35x194mm
 2.8"×1.4"×7.6"
 320g/0.7lb



1.5V AAA*3



ACCESSORIES

Carry bag
 Test Leads
 Temperature probe
 Battery



Calibration Certificate



Quick Start Guide

PACKAGING INFORMATION



Color Box
 L146×W45×H225mm



Carton Box
 50×31.5×25cm



X 20PCS



DIGITAL CLAMP METER - TRUE RMS
MS2109D

SKU NO.: MS2109DCBGLO
EAN CODE: 8435394788432

FEATURE

- True RMS / Relative / LED / Flashlight
- Overload Protection
- Non-Contact Voltage (NCV) Detection
- Live Wire(Live) Recognition

SPECIFICATIONS

AC Voltage 750V	DC Voltage 1000V	AC Current 1000A
DC Current 1000A	Resistance 60MΩ	Frequency 10MHz
Capacitance 10mF	Jaw Opening 23mm	Display Counts 6000
Temperature -20°C~1000°C		

MAIN APPLICATIONS

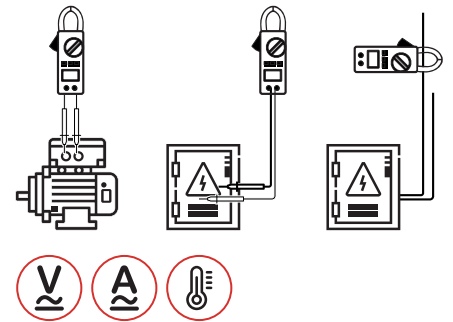
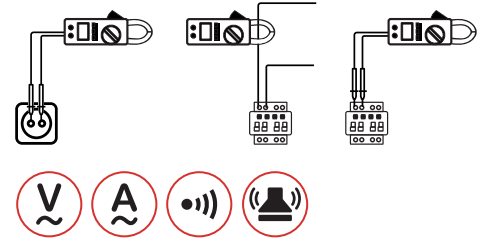

CONTENTS



72x35x194mm
2.8"×1.4"×7.6"
320g/0.7lb



1.5V AAA*3



ACCESSORIES

Carry bag
Test Leads
Temperature probe
Battery



Calibration Certificate



Quick Start Guide

PACKAGING INFORMATION



Color Box
L146×W45×H225mm



Carton Box
50×31.5×25cm



X 20PCS



INFRARED THERMOMETER
MS6523A

SKU NO.: MS6523ACBGLO
EAN CODE: 8435394788593

FEATURE

- °C / °F Conversion
- Backlight

SPECIFICATIONS

Temperature Measuring
-50°C~500°C / -58°F~932°F

Repeatability
±1°C (2°F)

Emissivity
0.1~1.00

MAIN APPLICATIONS

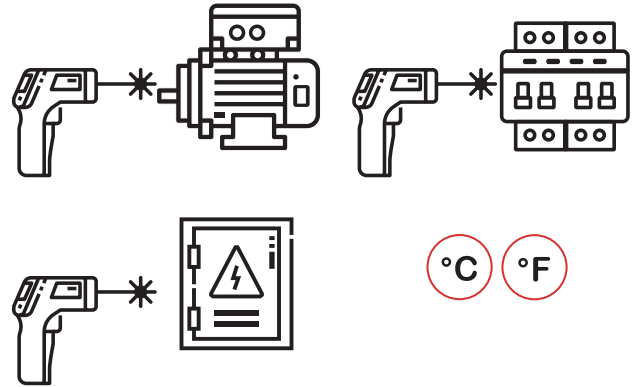

CONTENTS

 155x92x42mm
6.1"x3.6"x1.6"
180g/0.39lb

 1.5V AAA*2

 Battery
ACCESSORIES

 Calibration Certificate

 Quick Start Guide

PACKAGING INFORMATION

 **Color Box**
L120xW50xH180mm

 **Carton Box**
53x38x38cm

 **X 60PCS**



INFRARED THERMOMETER

MS6523B

SKU NO.: MS6523BCBGLO
EAN CODE: 8435394788609

FEATURE

- °C / °F Conversion
- Backlight

SPECIFICATIONS

Temperature Measuring
-50°C~700°C / -58°F~1292°F

Repeatability
±1°C (2°F)

Emissivity
0.1~1.00

MAIN APPLICATIONS

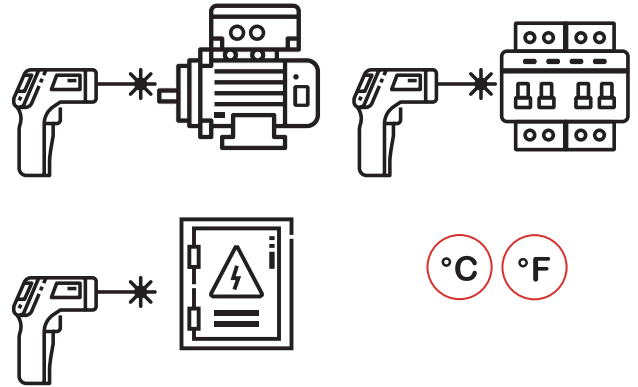

CONTENTS



155x92x42mm
6.1"x3.6"x1.6"
180g/0.39lb



1.5V AAA*2



ACCESSORIES

Battery



Calibration
Certificate



Quick Start
Guide

PACKAGING INFORMATION



Color Box
L120xW50xH180mm



Carton Box
53x38x38cm



X 60PCS



INFRARED THERMOMETER
MS6523C

SKU NO.: MS6523CCBGLO
EAN CODE: 8435394788616

FEATURE

- °C / °F Conversion
- Backlight

SPECIFICATIONS

Temperature Measuring
-50°C~900°C / -58°F~1652°F

Repeatability
±1°C (2°F)

Emissivity
0.1~1.00

MAIN APPLICATIONS

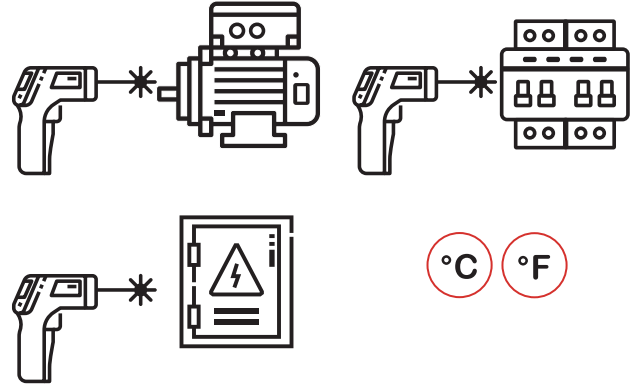

CONTENTS

 155x92x42mm
6.1"x3.6"x1.6"
180g/0.39lb

 1.5V AAA*2

 Battery
ACCESSORIES

 Calibration Certificate

 Quick Start Guide

PACKAGING INFORMATION

 **Color Box**
L120xW50xH180mm

 **Carton Box**
53x38x38cm

 **X 60PCS**



INFRARED THERMOMETER
MS6525A

SKU NO.: MS6525ACBGLO
EAN CODE: 8435394788821

FEATURE

- °C / °F Conversion
- Backlight
- VA Color Screen
- Screen Size: 41*39mm

SPECIFICATIONS

Temperature Measuring
-32°C~1100°C / -26°F~2012°F

Repeatability
±1°C (2°F)

Emissivity
0.1~1.00

MAIN APPLICATIONS

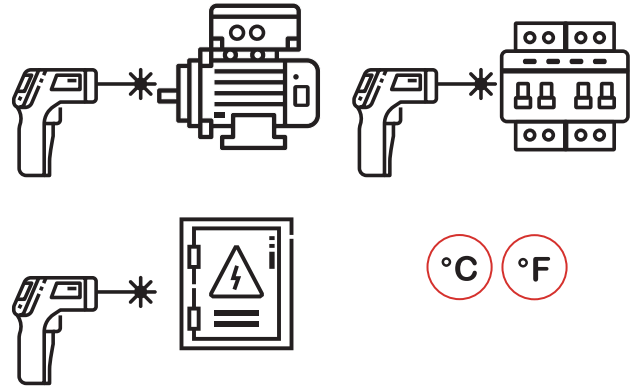

CONTENTS

- 213x140x60mm
8.4"x5.5"x2.4"
360g/0.79lb
- 9V 6F22 Battery
- Carry bag
- Battery
- Calibration Certificate
- Quick Start Guide

PACKAGING INFORMATION

- Color Box**
L221xW90xH286mm
- Carton Box**
59x47x24cm
- X 10PCS**



INFRARED THERMOMETER
MS6525B

SKU NO.: MS6525BCBGLO
EAN CODE: 8435394788838

FEATURE

- °C / °F Conversion
- Backlight
- VA Color Screen
- Screen Size: 41*39mm

SPECIFICATIONS

Temperature Measuring
-32°C~1400°C / -26°F~2552°F

Repeatability
±1°C (2°F)

Emissivity
0.1~1.00

MAIN APPLICATIONS

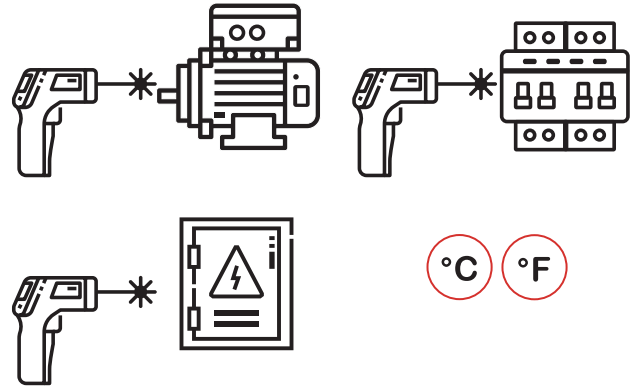

CONTENTS

- 213x140x60mm
8.4"x5.5"x2.4"
360g/0.79lb
- 9V 6F22 Battery
- Carry bag
- Battery
- Calibration Certificate
- Quick Start Guide

PACKAGING INFORMATION

- Color Box**
L221xW90xH286mm
- Carton Box**
59x47x24cm
- X 10PCS**



K/J THERMOMRTER
MS6503

SKU NO.: MS6503CBGLO
EAN CODE: 8435394788630

FEATURE

- Type: Dual Channel
- Temperature Difference
- Screen Size: 37*41mm

SPECIFICATIONS

Temperature Measuring
-200°C~1372°C / -328°F~2501°F

Resolution
1°C / °F

ADJ
-9°C~9°C

MAIN APPLICATIONS

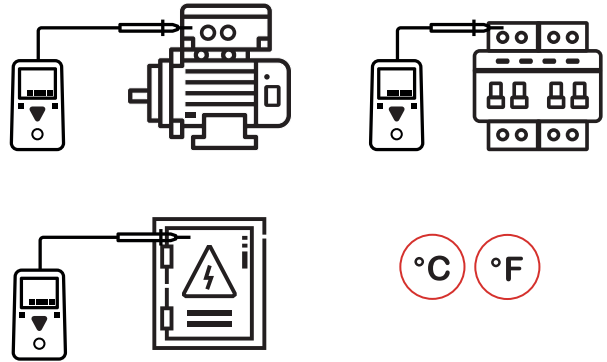

CONTENTS

- 152x55x33mm
5.9"x2.2"x1.3"
125g/0.27lb
- 1.5V AAA*3
- Carry bag
K Type Temperature probe
Battery
- Calibration Certificate
- Quick Start Guide

PACKAGING INFORMATION

- Color Box**
L89xW42xH210mm
- Carton Box**
46x37x23cm
- X 40PCS**



K/J THERMOMETER
MS6512A

SKU NO.: MS6512ACBGLO
EAN CODE: 8435394788647

FEATURE

- Type: Single Channel
- Temperature Difference
- Screen Size: 53*44mm

SPECIFICATIONS

Temperature Measuring -200°C~1372°C / -328°F~2501°F	Resolution 0.1°C/°F
ADJ -9°C~9°C	Display Counts 9999
Bracket num 1/4inch nut	Ambient 0°C~60°C

MAIN APPLICATIONS

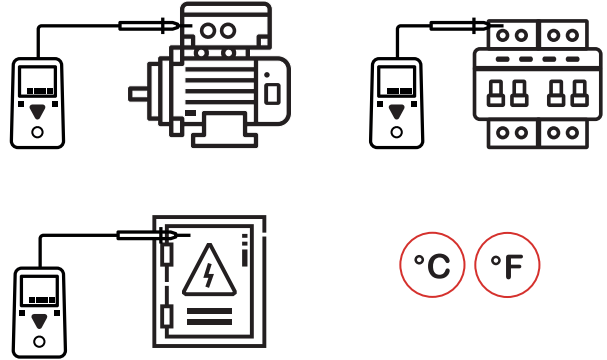

CONTENTS

- 177x70x35mm
6.9"x2.7"x1.4"
189g/0.41lb
- 1.5V AA*3 /
USB micro
interface 5V
- Carry bag
K Type Temperature
probe
Battery
- Calibration
Certificate
- Quick Start
Guide

PACKAGING INFORMATION

- Color Box**
L110xW60xH288mm
- Carton Box**
63x46.5x29.5cm
- X 40PCS**



K/J THERMOMRTER
MS6512B

SKU NO.: MS6512BCBGLO
EAN CODE: 8435394788654

FEATURE

- Type: Dual Channel
- Temperature Difference
- Screen Size: 53*44mm

SPECIFICATIONS

Temperature Measuring -200°C~1372°C / -328°F~2501°F		Resolution 0.1°C/°F
ADJ -9°C~9°C	Display Counts 9999	Ambient 0°C~60°C
Bracket num 1/4inch nut		

MAIN APPLICATIONS

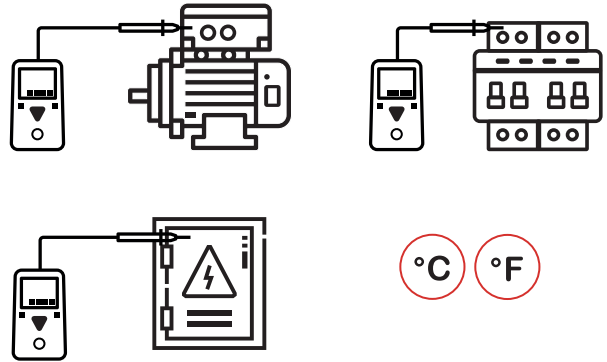

CONTENTS

177x70x35mm 6.9"x2.7"x1.4" 189g/0.41lb	1.5V AA*3 / USB micro interface 5V
Carry bag K Type Temperature probe Battery	Calibration Certificate
	Quick Start Guide

PACKAGING INFORMATION

Color Box L110xW60xH288mm	
Carton Box 63x46.5x29.5cm	X 40PCS



K/J THERMOMRTER
MS6512C

SKU NO.: MS6512CCBGLO
EAN CODE: 8435394788661

FEATURE

- Type: Four Channel
- Temperature Difference
- Screen Size: 53*44mm

SPECIFICATIONS

Temperature Measuring -200°C~1372°C / -328°F~2501°F		Resolution 0.1°C/°F
ADJ -9°C~9°C	Display Counts 5000	Ambient 0°C~60°C
Bracket num 1/4inch nut		

MAIN APPLICATIONS

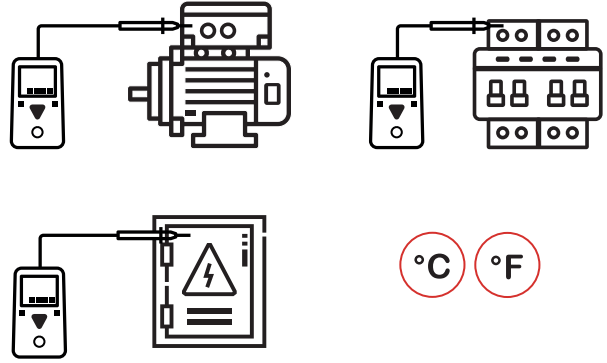

CONTENTS

177x70x35mm 6.9"x2.7"x1.4" 189g/0.41lb	1.5V AA*3 / USB micro interface 5V
Carry bag K Type Temperature probe Battery	Calibration Certificate
	Quick Start Guide

PACKAGING INFORMATION

Color Box L110xW60xH288mm	
Carton Box 63x46.5x29.5cm	X 40PCS



MINI THERMO-HYGROMETER
MS6509

SKU NO.: MS6509CBGLO
EAN CODE: 8435394788456

FEATURE

- Temperature Measurement
- Humidity Measurement
- °C / °F Selection
- MAX / MIN

SPECIFICATIONS

Temperature Measuring
0°C~60°C / 32°F~140°F

Humidity
0%~100%RH

Display Counts
9999

MAIN APPLICATIONS

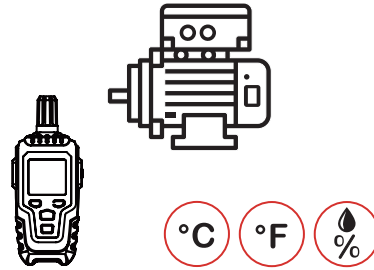

CONTENTS



154x59x30mm
6.0"x2.3"x1.2"
106g/0.23lb



1.5V AAA*3



Battery

ACCESSORIES



Calibration Certificate



Quick Start Guide

PACKAGING INFORMATION



Color Box
L154xW59xH190mm



Carton Box
45.5x41x23cm



X 40PCS



MOISTURE METER

MS6901

SKU NO.: MS6901CBGLO
 EAN CODE: 8435394788739

FEATURE

- Screen Size: 37*41mm

SPECIFICATIONS

Measuring Range 0~54.8%RH	Resolution 0.1%RH	Humidity 0%~100%RH
Display Counts 1999		

MAIN APPLICATIONS

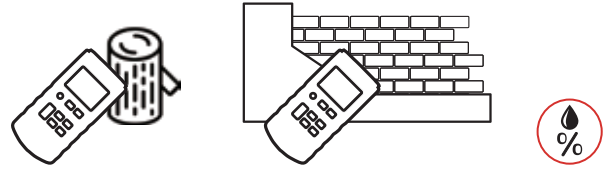

CONTENTS

	145x55x33mm 5.7"x2.2"x1.3" 115g/0.25lb		1.5V AAA*3
	Carry bag		Calibration Certificate
	Battery		Quick Start Guide
	ACCESSORIES		

PACKAGING INFORMATION

	Color Box L89xW42xH210mm	
	Carton Box 46x37x23cm	X 40PCS



TACHOMETER

MS6208C

SKU NO.: MS6208CCBGLO
EAN CODE: 8435394788852

FEATURE

- Screen Size: 37*41mm
- Display: 6 digits, max 999999
- Auto Power Off

SPECIFICATIONS

Range
2.5RPM~99999RPM(rpm/mins)

Temperature
0~60°C

Effective Distance
50~500mm

MAIN APPLICATIONS

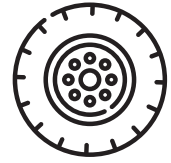
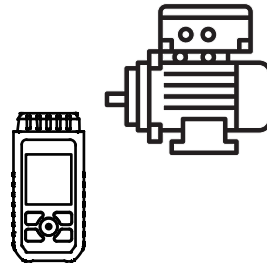

rpm

CONTENTS



152×55×33mm
5.9"×2.2"×1.3"
125g/0.28lb



1.5V AAA*3



ACCESSORIES

Carry bag
Reflective tape*2
Battery



Calibration
Certificate



QSG

Quick Start
Guide

PACKAGING INFORMATION



Color Box
L89×W42×H210mm



Carton Box
45×38×23cm



X 40PCS



WIRE TRACKER TRANSMITTER
MS6815B

SKU NO.: MS6815BCBGLO
EAN CODE: 8435394788586

FEATURE

- Smart Digital Line Finding
- Humanized Network Cable Sequence Alignment
- POE Switch Tracking

SPECIFICATIONS

Open & Short Circuit LED indication	Sensitivity 0~5cm
Open and Circuit Voltage Test LED indication	
Telephone Line Status LED indication	

MAIN APPLICATIONS

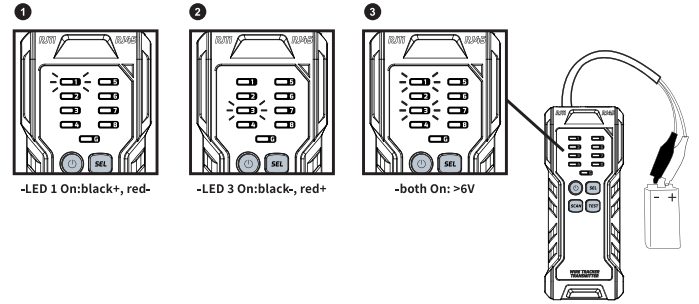

CONTENTS

- 151x100x35mm
5.9"x3.9"x1.38"
167g/0.37lb
- 9V Battery*2
- Carry bag
- Network cable
- Alligator clip
- Battery
- Calibration Certificate
- Quick Start Guide

PACKAGING INFORMATION

- Color Box**
L120xW50xH180mm
- Carton Box**
53x38x26cm
- X 40PCS**



MINI LUX METER

MS6612A

SKU NO.: MS6612ACBGLO
EAN CODE: 8435394788470

FEATURE

- LUX Measurement
- Temperature Measurement
- LCD
- Unit Selection

SPECIFICATIONS

Measuring Range(LUX)
0LUX~200KLUX

Resolution
1LUX / 1FC

Measuring Range(FC)
0FC~20KFC

Display Counts
9999

Temperature Range
0°C~60°C / 32°F~140°F

MAIN APPLICATIONS

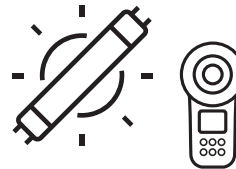
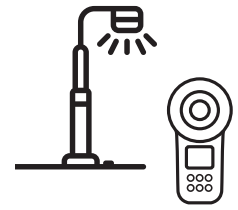
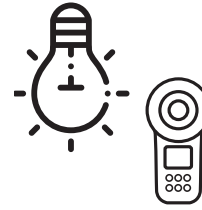

Lux

CONTENTS



154x59x30mm
6.0"x2.3"x1.2"
116g/0.25lb



1.5V AAA*3



ACCESSORIES

Battery



Calibration Certificate



Quick Start Guide

PACKAGING INFORMATION



Color Box
L102xW40xH190mm



Carton Box
45.5x41x30cm



X 40PCS



DIGITAL LIGHT METER
MS6613A

SKU NO.: MS6613ACBGLO
EAN CODE: 8435394788678

FEATURE

- Digital Light Probes and Filters
- Auto Power Off
- Screen Size: 53*44mm

SPECIFICATIONS

Measuring Range 0.1~200000LUX	Resolution 1LUX / 1FC
Measuring Level 19999*10 LUX / 19999 FC	Ambient 0°C~60°C
Spectral Range 400~700nm	Display Counts 9999

MAIN APPLICATIONS

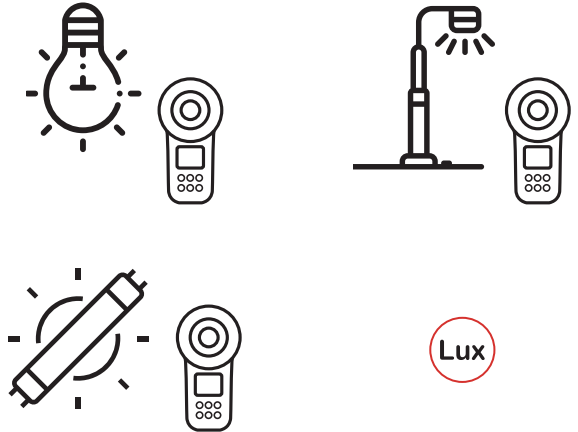

CONTENTS

256x67x35mm 10.0"x2.6"x1.4" 250g/0.55lb	1.5V AA*3
Carry bag Battery	Calibration Certificate
ACCESSORIES	Quick Start Guide

PACKAGING INFORMATION

Color Box L110xW60xH288mm	
Carton Box 63x46.5x29.5cm	X 40PCS



DIGITAL LIGHT METER

MS6613B

SKU NO.: MS6613BCBGLO
EAN CODE: 8435394788685

FEATURE

- USB Connection
- Digital Light Probes and Filters
- Auto Power Off
- Screen Size: 53*44mm

SPECIFICATIONS

Measuring Range
0.1~200000LUX

Resolution
1LUX / 1FC

Measuring Level
19999*10 LUX / 19999 FC

Ambient
0°C~60°C

Spectral Range
400~700nm

Display Counts
9999

MAIN APPLICATIONS

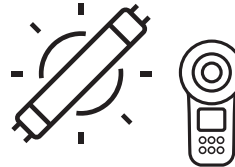
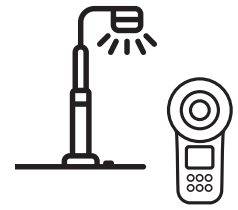
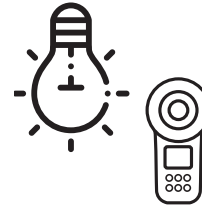

Lux

CONTENTS



256x67x35mm
10.0"x2.6"x1.4"
250g/0.55lb



1.5V AA*3



Carry bag
Battery



Calibration
Certificate

ACCESSORIES



Quick Start
Guide

PACKAGING INFORMATION



Color Box
L110xW60xH288mm



Carton Box
63x46.5x29.5cm



X 40PCS



MINI ANEMOMETER

MS6652C

SKU NO.: MS6652CCBGLO
EAN CODE: 8435394788449

FEATURE

- Air Velocity Measurement
- Air Velocity Grade
- Temperature Measurement
- Air Volume Measurement

SPECIFICATIONS

Air Velocity 0.4~30.0m/S	Air Velocity 1.4~108km/h	Air Velocity 0.9~67.0mph
Air Velocity 0.8~58.0knots	Air Velocity 80~5900ft/min	Display Counts 9999
Air Volume Measurement CMM / CFM / 0~9999	Accuracy 0.1°C/ 0.1°F	

MAIN APPLICATIONS

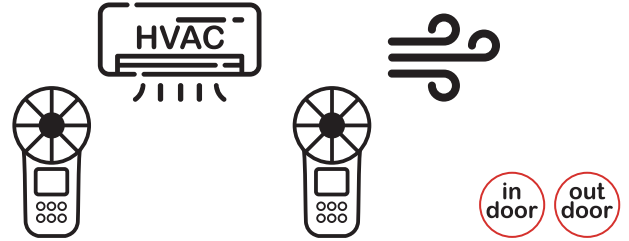

CONTENTS

	154x59x30mm 6.0"x2.3"x1.2" 108g/0.24lb		1.5V AAA*3
	Battery		Calibration Certificate
			Quick Start Guide

PACKAGING INFORMATION

	Color Box L102xW40xH190mm	
	Carton Box 45.5x41x30cm	X 40PCS



DIGITAL ANEMOMETER
MS6253A

SKU NO.: MS6253ACBGLO
EAN CODE: 8435394788692

FEATURE

- Measurement Method: Integral Type
- Seneor: Infrared Laser Tube Cutting Method
- USB micro interface 5V

SPECIFICATIONS

Air Velocity 0.06~45.0m/S	Air Velocity 1.0~162.0Km/h	Air Velocity 10~8858ft/m
Air Velocity 1.0~147.6ft/s	Air Velocity 1.0~100.6mile/h	Air Velocity 0.1~84.48Knots
Display Counts 1000	Air Volume Measurement CMM / CFM / CMS / 0~9999m³	

MAIN APPLICATIONS

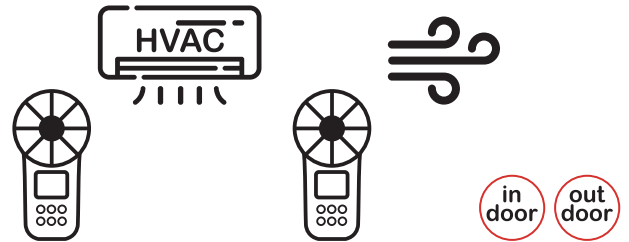

CONTENTS

- 239x73x35mm
9.1"x2.9"x1.4"
210g/0.46lb
- 1.5V AAA*3 /
USB micro
interface 5V
- Carry bag
USB Cable
Battery
- Calibration
Certificate
- Quick Start
Guide

PACKAGING INFORMATION

- Color Box**
L110xW60xH288mm
- Carton Box**
63x46.5x29.5cm
- X 40PCS**



DIGITAL ANEMOMETER

MS6253B

SKU NO.: MS6253BCBGLO
EAN CODE: 8435394788708

FEATURE

- Measurement Method: Integral Type
- Seneor: Infrared Laser Tube Cutting Method
- USB micro interface 5V
- USB Connection

SPECIFICATIONS

Air Velocity 0.06~45.0m/S	Air Velocity 1.0~162.0Km/h	Air Velocity 10~8858ft/m
Air Velocity 1.0~147.6ft/s	Air Velocity 1.0~100.6mile/h	Air Velocity 0.1~84.48Knots
Display Counts 1000	Air Volume Measurement CMM / CFM / CMS / 0~9999m³	

MAIN APPLICATIONS

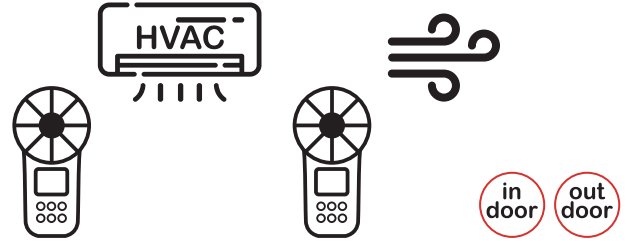

CONTENTS

- 239x73x35mm
9.1"x2.9"x1.4"
210g/0.46lb
- 1.5V AA*3 /
USB micro
interface 5V
- Carry bag
USB Cable
Battery
- Calibration
Certificate
- Quick Start
Guide

PACKAGING INFORMATION

- Color Box**
L110xW60xH288mm
- Carton Box**
63x46.5x29.5cm
- X 40PCS**



MINI SOUND LEVEL METER
MS6702A

SKU NO.: MS6702ACBGLO
EAN CODE: 8435394788463

FEATURE

- Loudness Measurement
- Temperature Measurement
- MAX / MIN
- Data Hold / Backlight

SPECIFICATIONS

Level Range 35~135dB	Resolution 0.1dB	Frequency 31.5Hz~8KHz
Dynamic Range 50dB		

MAIN APPLICATIONS

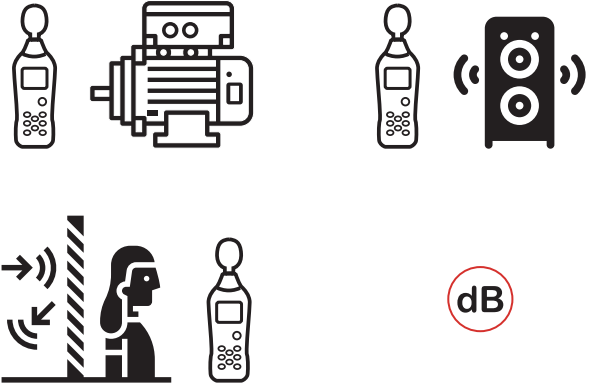

CONTENTS

154x59x30mm 6.0"x2.3"x1.2" 108g/0.24lb	1.5V AAA*3
Battery ACCESSORIES	Calibration Certificate
	Quick Start Guide

PACKAGING INFORMATION

Color Box L102xW40xH190mm	
Carton Box 45.5x41x30cm	X 40PCS



DIGITAL SOUND LEVEL METER
MS6703A

SKU NO.: MS6703ACBGLO
EAN CODE: 8435394788715

FEATURE

- Data Hold / Auto Power Off
- A / C Weighting
- USB micro interface 5V
- Screen Size: 53*44mm

SPECIFICATIONS

Measuring Range 30~130dB	Accuracy ±1.5dB	Response 31.5Hz~8KHz
Measuring Level 30~70dB, 60~90dB, 80~110dB, 100~130dB		

MAIN APPLICATIONS

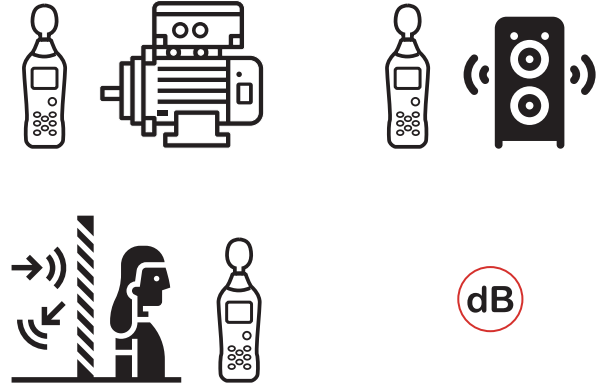

CONTENTS

- 229x70x35mm
9.0"x2.76"x1.38"
215g/0.47lb
- 1.5V AA*3 /
USB micro
interface 5V
- Carry bag
USB Cable
Battery
- Calibration
Certificate
- Quick Start
Guide

PACKAGING INFORMATION

- Color Box**
L110xW60xH288mm
- Carton Box**
63x46.5x29.5cm
- X 40PCS**



DIGITAL SOUND LEVEL METER
MS6703B

SKU NO.: MS6703BCBGLO
EAN CODE: 8435394788722

FEATURE

- Data Hold / Auto Power Off
- A / C / Z Weighting
- USB micro interface 5V
- Screen Size: 53*44mm

SPECIFICATIONS

Measuring Range 30~130dB	Accuracy ±1.5dB	Response 31.5Hz~8KHz
Measuring Level 30~70dB, 60~90dB, 80~110dB, 100~130dB		

MAIN APPLICATIONS

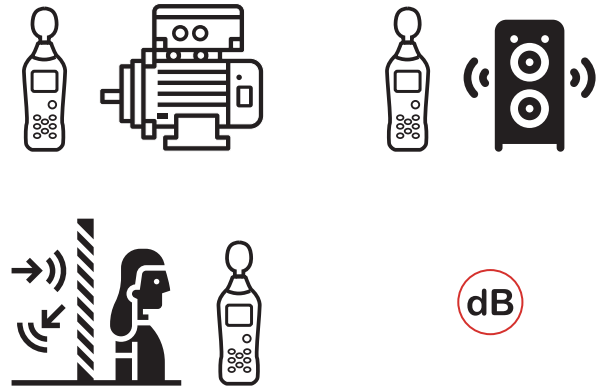

CONTENTS

229x70x35mm 9.0"x2.76"x1.38" 215g/0.47lb	1.5V AA*3 / USB micro interface 5V
Carry bag USB Cable Battery	Calibration Certificate
	Quick Start Guide

PACKAGING INFORMATION

Color Box L110xW60xH288mm	
Carton Box 63x46.5x29.5cm	X 40PCS



LASER DISTANCE METER
MS6406B

SKU NO.: MS6406BCBGLO
EAN CODE: 8435394789019

FEATURE

- Single Distance Measurement
- Area / Volume / Pythagorean Measurement
- Measurement Benchmark Switch
- Data Storage 99 Groups

SPECIFICATIONS

Range 0.05m~60m	Measurement Unit m, ft, in	Area Unit m², ft², in²
Laser Type 620~690nm	Laser Class Class II, <1mW	

MAIN APPLICATIONS

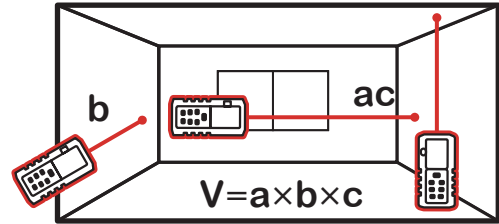
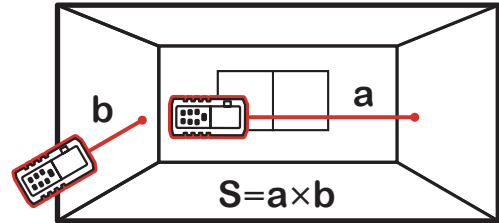

CONTENTS

- 130x59x28mm
5.12"x2.32"x1.1"
120g/0.26lb
- 1.5V AAA*3
- Strip
USB cable
Battery
- Calibration
Certificate
- QSG
Quick Start
Guide

PACKAGING INFORMATION

- Color Box**
L75xW55xH155mm
- Carton Box**
41x32.5x30.5cm
- X 50PCS



LASER DISTANCE METER
MS6408B

SKU NO.: MS6408BCBGLO
EAN CODE: 8435394789026

FEATURE

- Single Distance Measurement
- Area / Volume / Pythagorean Measurement
- Measurement Benchmark Switch
- Data Storage 99 Groups

SPECIFICATIONS

Range 0.05m~80m	Measurement Unit m, ft, in	Area Unit m², ft², in²
Laser Type 620~690nm	Laser Class Class II, <1mW	

MAIN APPLICATIONS

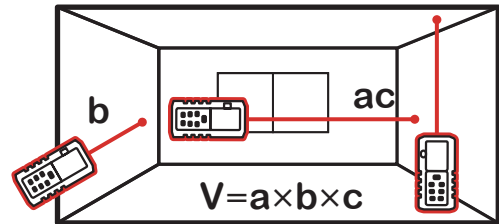
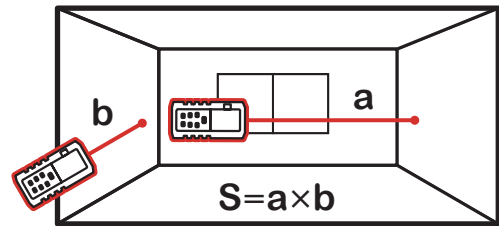

CONTENTS

- 130x59x28mm
5.12"x2.32"x1.1"
120g/0.26lb
- 1.5V AAA*3
- Strip
USB cable
Battery
- Calibration Certificate
- QSG
Quick Start Guide

PACKAGING INFORMATION

- Color Box**
L75xW55xH155mm
- Carton Box**
41x32.5x30.5cm
- X 50PCS**



LASER DISTANCE METER
MS6410B

SKU NO.: MS6410BCBGLO
EAN CODE: 8435394789033

FEATURE

- Single Distance Measurement
- Area / Volume / Pythagorean Measurement
- Measurement Benchmark Switch
- Data Storage 99 Groups

SPECIFICATIONS

Range 0.05m~100m	Measurement Unit m, ft, in	Area Unit m², ft², in²
Laser Type 620~690nm	Laser Class Class II, <1mW	

MAIN APPLICATIONS

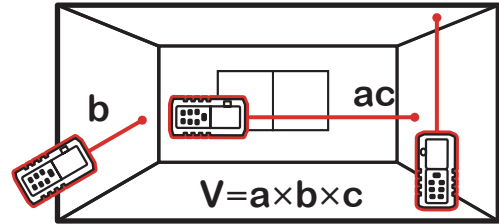
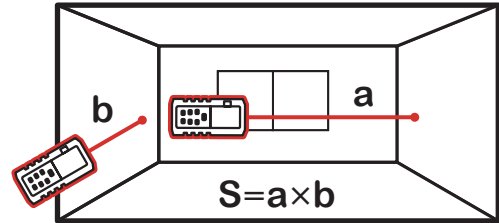

CONTENTS

- 130x59x28mm
5.12"x2.32"x1.1"
120g/0.26lb
- 1.5V AAA*3
- Strip
USB cable
Battery
- Calibration
Certificate
- QSG
Quick Start
Guide

PACKAGING INFORMATION

- Color Box**
L75xW55xH155mm
- Carton Box**
41x32.5x30.5cm
- X 50PCS



SOCKET TESTER

MS6861A

SKU NO.: MS6861ACBGLO
EAN CODE: 8435394788784

FEATURE

- Leakage Test Voltage Range: AC 220V±20V
- Socket Specification: CHN plug, UK plug, EU plug, US plug

SPECIFICATIONS

AC Voltage
175~250V / 50~60Hz

Temperature
0~40°C

Humidity
20%~75%RH

Leakage Test Current
>30mA

MAIN APPLICATIONS

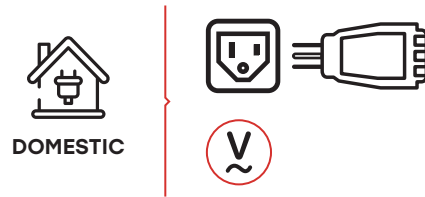

CONTENTS



87x58x63mm
3.4x2.3"x2.5"
90g/0.2lb



Calibration
Certificate



Quick Start
Guide

PACKAGING INFORMATION



Color Box
L98xW72xH78mm



Carton Box
51x31x41.5cm



X 100PCS



DISPLAY TYPE SOCKET TESTER
MS6863A

SKU NO.: MS6863ACBGLO
EAN CODE: 8435394788814

FEATURE

- Leakage Test Voltage Range: AC 220V±20V
- Socket Specification: CHN plug, UK plug, EU plug, US plug
- LCD Panel diagram

SPECIFICATIONS

AC Voltage 175~250V / 50~60Hz	Temperature 0~40°C
Humidity 20%~75%RH	Leakage Test Current >30mA

MAIN APPLICATIONS

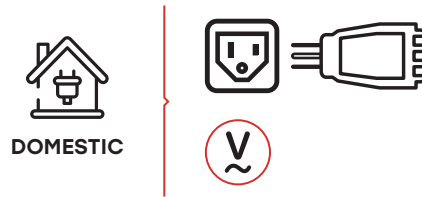

CONTENTS

- 87x58x63mm
3.4x2.3"x2.5"
90g/0.2lb
- Calibration Certificate
- Quick Start Guide

PACKAGING INFORMATION

- Color Box**
L98xW72xH78mm
- Carton Box**
51x31x41.5cm
- X 100PCS**



GAS LEAK DETECTOR

MS6311A

SKU NO.: MS6311ACBGLO
EAN CODE: 8435394788746

FEATURE

- Screen Size: 53*44mm
- USB micro interface
- Display Mode: Analog Bar
- Alarm Mode: Display, Sound & Light alarm

SPECIFICATIONS

Sensitivity 50PPM(CH4)	Range %LEL:0~20%, PPM:0~9999PPM
Resolution (%LEL) 0~20%(0.1)	Resolution (PPM) 0~999PPM(0.1), 1000~999PPM(1)

MAIN APPLICATIONS

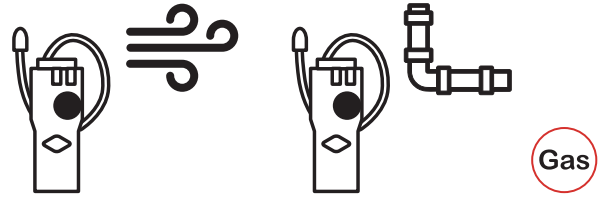

CONTENTS

192x70x35mm 7.6"x2.76"x1.38" 275g/0.61lb	3.7V / 1000mAh Li Battery / USB micro interface (DC 5V / 1A)
Carry bag USB Cable Battery	Calibration Certificate
	Quick Start Guide

PACKAGING INFORMATION

Color Box L146xW42xH252mm	
Carton Box 52.5x42x25.2cm	X 40PCS



GAS LEAK DETECTOR

MS6311B

SKU NO.: MS6311BCBGLO
EAN CODE: 8435394788753

FEATURE

- Screen Size: 53*44mm
- USB micro interface
- Display Mode: Analog Bar
- Alarm Mode: Display, Sound & Light alarm

SPECIFICATIONS

Sensitivity 50PPM(CH4)	Range %LEL:0~20%, PPM:0~9999PPM
Resolution (%LEL) 0~20%(0.1)	Resolution (PPM) 0~999PPM(0.1), 1000~999PPM(1)
Ambient Temp. 0~60°C	

MAIN APPLICATIONS



CONTENTS

- 192x70x35mm
7.6"x2.76"x1.38"
275g/0.61lb
- 3.7V / 1000mAh
Li Battery /
USB micro interface
(DC 5V / 1A)
- Carry bag
USB Cable
Battery
- Calibration
Certificate
- Quick Start
Guide

PACKAGING INFORMATION

- Color Box**
L146xW42xH252mm
- Carton Box**
52.5x42x25.2cm
- X 40PCS**

DIGITAL MULTIMETERS

MANUAL RANGE | AUTO RANGE | POCKET & PEN TYPE
BENCH TYPE | SPECIAL APPLICATION





POCKET DIGITAL MULTIMETER
M3900

SKU NO.: M3900CBGLO
UPC CODE: 810053674062
EAN CODE: 8435394779133

FEATURE

- Display 2000 Counts.
- Diode Open Voltage 2.8v.
- Low Battery Display.

SPECIFICATIONS

AC Voltage 750V	DC Voltage 1000V	AC Current 10A
DC Current 10A	Resistance 20MΩ	Display Counts 2000

MAIN APPLICATIONS

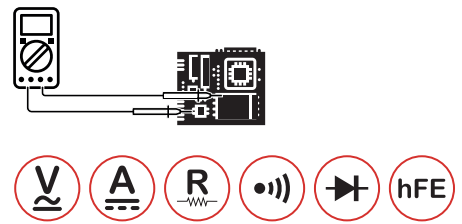
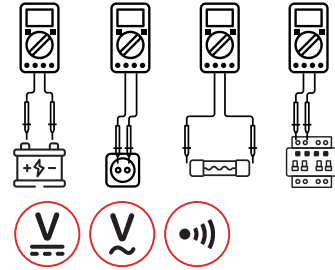

CONTENTS



172×88×36mm
6.7"×3.5"×1.4"
370g/0.8lb



1×9V 6F22
Battery



Test Leads



Calibration
Certificate

ACCESSORIES



Quick Start
Guide

PACKAGING INFORMATION



Color Box
L165×W70×H255mm



Carton Box
47×37.5×35.5cm



X 20PCS



POCKET DIGITAL MULTIMETER
M830B

SKU NO.: M830BCBGLO
UPC CODE: 810053672495
EAN CODE: 8435394778136

FEATURE

- Display 2000 Counts.
- Pocket Size.

SPECIFICATIONS

AC Voltage 600V	DC Voltage 600V	AC Current 10A
Resistance 200kΩ	Display Counts 2000	

MAIN APPLICATIONS

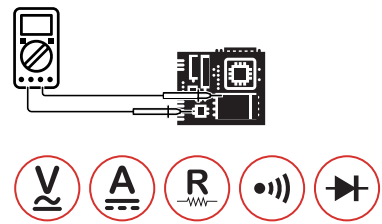
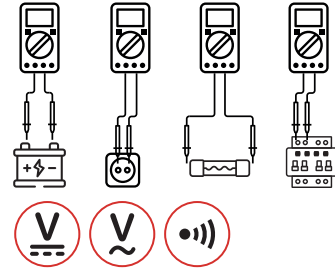

CONTENTS



126×70×25mm
4.9"×2.75"×0.9"
170g/0.4lb



1×9V 6F22
Battery



Test Leads



Calibration
Certificate

ACCESSORIES



Quick Start
Guide

PACKAGING INFORMATION



Color Box
L145×W60×H188mm



Carton Box
40×32×31.5cm



X 20PCS



POCKET DIGITAL MULTIMETER
M830BZ

SKU NO.: M830BZCBGLO
UPC CODE: 810053674581
EAN CODE: 8435394779652

FEATURE

- Display 2000 Counts.
- Pocket Size.

SPECIFICATIONS

AC Voltage 600V	DC Voltage 600V	AC Current 10A
Resistance 200kΩ	Display Counts 2000	

MAIN APPLICATIONS

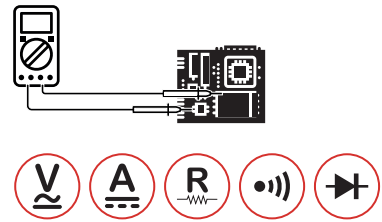
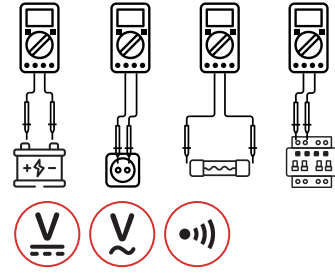

CONTENTS



126×70×25mm
4.9"×2.75"×0.9"
170g/0.4lb



1×9V 6F22
Battery



Test Leads



Calibration
Certificate

ACCESSORIES



Quick Start
Guide

PACKAGING INFORMATION



Color Box
L145×W60×H188mm



Carton Box
40×32×31.5cm



X 20PCS



POCKET DIGITAL MULTIMETER
M832

SKU NO.: M832CBGLO
UPC CODE: 810053672501
EAN CODE: 8435394778143

FEATURE

- Display 2000 Counts.
- Pocket Size.

SPECIFICATIONS

AC Voltage 600V	DC Voltage 600V	AC Current 10A
Resistance 2MΩ	Display Counts 2000	Continuity <50Ω

MAIN APPLICATIONS

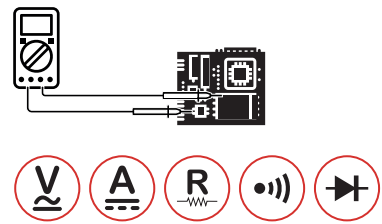
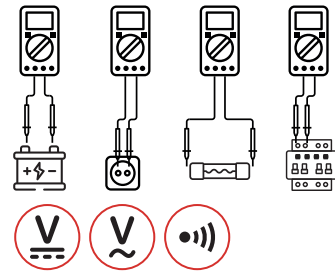

CONTENTS



126×70×25mm
4.9"×2.75"×0.9"
170g/0.4lb



1×9V 6F22
Battery



Test Leads



Calibration
Certificate

ACCESSORIES



Quick Start
Guide

PACKAGING INFORMATION



Color Box
L145×W60×H188mm



Carton Box
40×32×31.5cm



X 20PCS



POCKET DIGITAL MULTIMETER
M838

SKU NO.: M838CBAGLO
UPC CODE: 810053672518
EAN CODE: 8435394778150

FEATURE

- Display 2000 Counts.
- Pocket Size.

SPECIFICATIONS

AC Voltage 600V	DC Voltage 600V	AC Current 10A
Resistance 200kΩ	Display Counts 2000	Continuity <50Ω
Temperature -20~1370°C		

MAIN APPLICATIONS

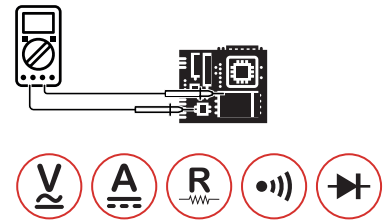
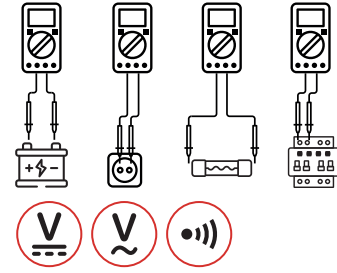

CONTENTS



126×70×25mm
4.9"×2.75"×0.9"
170g/0.4lb



1×9V 6F22
Battery



Test Leads
K-type thermocouple

ACCESSORIES



Calibration
Certificate



Quick Start
Guide

PACKAGING INFORMATION



Color Box
L145×W60×H188mm



Carton Box
40×32×31.5cm



X 20PCS



MAIN APPLICATIONS

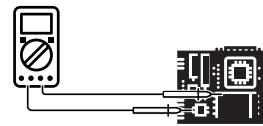
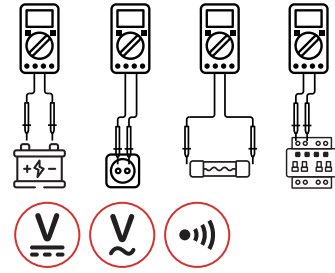

DIGITAL MULTIMETER
MAS830

SKU NO.: MAS830CBGLO
UPC CODE: 810053672525
EAN CODE: 8435394778167

FEATURE

- Diode Open Voltage 3.0V.
- Data Hold.
- Low Battery Display.
- Sample Rate 500mS.

SPECIFICATIONS

AC Voltage 600V	DC Voltage 600V	DC Current 10A
Resistance 2MΩ	Display Counts 2000	Continuity <70±30Ω

CONTENTS



145×76×40mm
5.7"×3"×1.57"
202g/0.44lb



1×9V 6F22
Battery



Test Leads



Calibration
Certificate

ACCESSORIES



Quick Start
Guide

PACKAGING INFORMATION



Color Box
L145×W60×H188mm



Carton Box
40×32×31.5cm



X 20PCS



DIGITAL MULTIMETER

MAS830B

SKU NO.: MAS830BCBGLO
 UPC CODE: 810053674864
 EAN CODE: 8435394782072

FEATURE

- Diode Open Voltage 3.0V.
- Data Hold.
- Low Battery Display.

SPECIFICATIONS

AC Voltage 600V	DC Voltage 600V	DC Current 10A
Resistance 2MΩ	Display Counts 2000	

MAIN APPLICATIONS

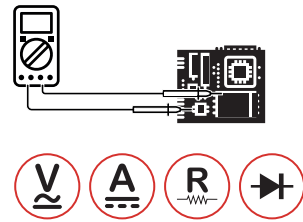
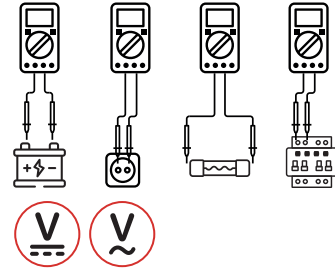

CONTENTS



145×76×40mm
 5.7"×3"×1.57"
 202g/0.44lb



1×9V 6F22
 Battery



Test Leads



Calibration
 Certificate

ACCESSORIES



Quick Start
 Guide

PACKAGING INFORMATION



Color Box
 L145×W60×H188mm



Carton Box
 40×32×31.5cm



X 20PCS



DIGITAL MULTIMETER

MAS830L

SKU NO.: MAS830LCBGLO
 UPC CODE: 810053671993
 EAN CODE: 843539477726

FEATURE

- Diode Open Voltage 3.0V.
- Data Hold.
- Low Battery Display.
- Continuity Buzzer <math><70 \pm 30\Omega</math>.

SPECIFICATIONS

AC Voltage 600V	DC Voltage 600V	DC Current 10A
Resistance 2MΩ	Display Counts 2000	Continuity <math><70 \pm 30\Omega</math>

MAIN APPLICATIONS

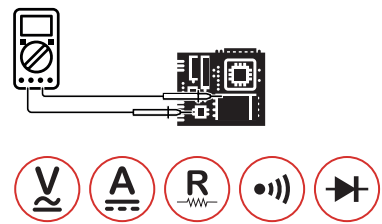
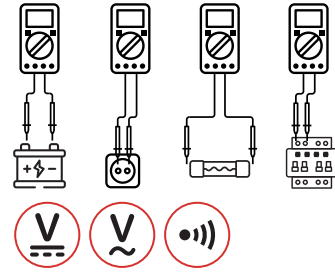

CONTENTS



145x76x40mm
 5.7"x3"x1.57"
 202g/0.44lb



1x9V 6F22
 Battery



Test Leads



Calibration
 Certificate

ACCESSORIES



Quick Start
 Guide

PACKAGING INFORMATION



Color Box
 L145xW60xH188mm



Carton Box
 40x32x31.5cm



X 20PCS



MAIN APPLICATIONS

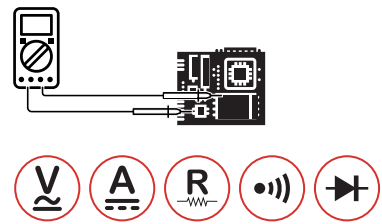
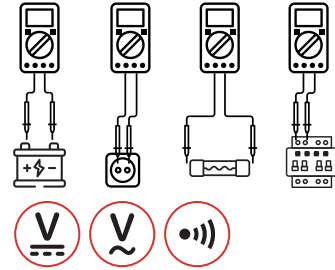

DIGITAL MULTIMETER

MAS838

SKU NO.: MAS838CBGLO
 UPC CODE: 810053672365
 EAN CODE: 8435394784304

FEATURE

- Diode Open Voltage 3.0V.
- Data Hold.
- Low Battery Display.
- Continuity Buzzer <math><70 \pm 30\Omega</math>.

SPECIFICATIONS

AC Voltage 600V	DC Voltage 600V	DC Current 10A
Resistance 2MΩ	Display Counts 2000	Continuity <math><70 \pm 30\Omega</math>
Temperature -20°C~1000°C		

CONTENTS



145×76×40mm
 5.7"×3"×1.57"
 202g/0.44lb



1×9V 6F22
 Battery



Test Leads
 K-type thermocouple

ACCESSORIES



Calibration
 Certificate



Quick Start
 Guide

PACKAGING INFORMATION



Color Box
 L145×W60×H188mm



Carton Box
 40×32×31.5cm



X 20PCS



DIGITAL MULTIMETER

MS8233A

SKU NO.: MS8233ACBGLO
 UPC CODE: 810053673140
 EAN CODE: 8435394778877

FEATURE

- Diode Open Voltage 3.0V.
- Continuity Buzzer <60Ω.
- Data Hold.
- Low Battery Display.

SPECIFICATIONS

AC Voltage 600V	DC Voltage 600V	DC Current 10A
Resistance 2MΩ	Continuity <60Ω	Display Counts 2000

MAIN APPLICATIONS

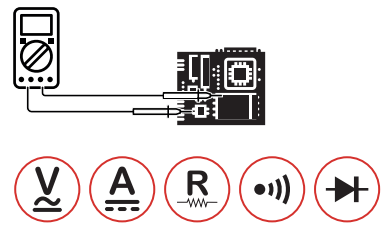
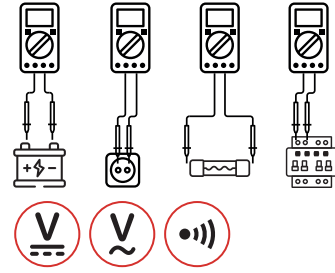

CONTENTS



140×67×30mm
 5.5"×2.6"×1.2"
 112g/0.25lb



1×9V 6F22
 Battery



Test Leads
 Battery

ACCESSORIES



Calibration
 Certificate



Quick Start
 Guide

PACKAGING INFORMATION



Color Box
 L145×W60×H188mm



Carton Box
 49×28×37cm



X 20PCS



DIGITAL MULTIMETER
MS8233B

SKU NO.: MS8233BCBGLO
UPC CODE: 810053674840
EAN CODE: 8435394783369

FEATURE

- Diode Open Voltage 3.0V.
- Low Battery Display.
- Display Backlight.
- Non-contact Voltage Detection.

SPECIFICATIONS

AC Voltage 600V	DC Voltage 600V	DC Current 10A
Resistance 2MΩ	Continuity <60Ω	Display Counts 2000

MAIN APPLICATIONS

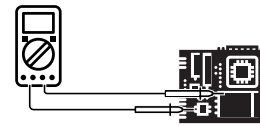
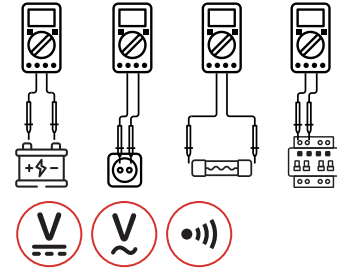

CONTENTS



140×67×30mm
5.5"×2.6"×1.2"
112g/0.25lb



1×9V 6F22
Battery



Test Leads
Battery



Calibration
Certificate

ACCESSORIES



Quick Start
Guide

PACKAGING INFORMATION



Color Box
L145×W60×H188mm



Carton Box
40×32×31.5cm



X 20PCS



DIGITAL MULTIMETER

MS8233C

SKU NO.: MS8233CCBGLO
 UPC CODE: 810053672228
 EAN CODE: 8435394777948

FEATURE

- Diode Open Voltage 3.0V.
- Low Battery Display.
- Display Backlight.
- Non-contact Voltage Detection.

SPECIFICATIONS

AC Voltage 600V	DC Voltage 600V	DC Current 10A
Resistance 2MΩ	Continuity <60Ω	Display Counts 2000
Temperature -20°C~1000°C/-4°F~1832°F		

MAIN APPLICATIONS

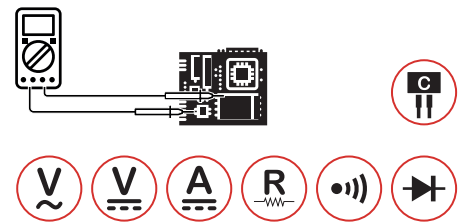
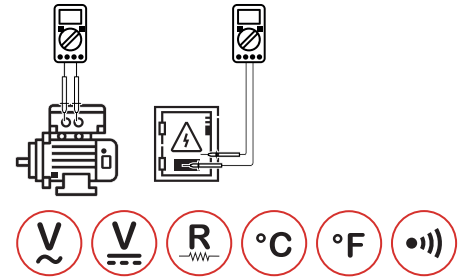
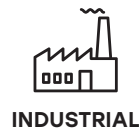
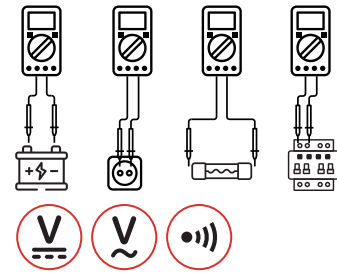

CONTENTS



140×67×30mm
 5.5"×2.6"×1.2"
 112g/0.25lb



1×9V 6F22
 Battery



ACCESSORIES

Test Leads
 K-type thermocouple
 Battery



Calibration
 Certificate



Quick Start
 Guide

PACKAGING INFORMATION



Color Box
 L145×W60×H188mm



Carton Box
 40×32×31.5cm



X 20PCS



DIGITAL MULTIMETER

MS8238

SKU NO.: MS8238CBGLO
 UPC CODE: 810053672662
 EAN CODE: 8435394778303

FEATURE

- Diode Open Voltage 3.0V.
- Battery Test 1.5V/9V/12V.
- Data Hold.
- Low Battery Display.

SPECIFICATIONS

AC Voltage 600V	DC Voltage 600V	DC Current 10A
Resistance 2MΩ	Continuity <50Ω	Display Counts 2000

MAIN APPLICATIONS



DOMESTIC

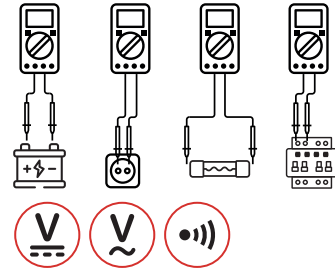

ELECTRONICS

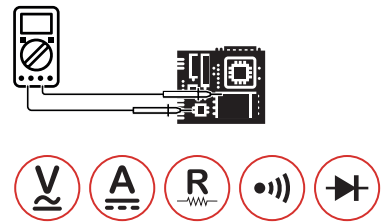

CONTENTS



148×73.5×50mm
 5.8"×2.9"×1.96"
 232g/0.51lb



1×9V 6F22
 Battery



Test Leads
 Battery

ACCESSORIES



Calibration
 Certificate



Quick Start
 Guide

PACKAGING INFORMATION



Color Box
 L145×W60×H188mm



Carton Box
 40×32×31.5cm



X 20PCS



DIGITAL MULTIMETER **MS8261**

SKU NO.: MS8261CBGLO
UPC CODE: 810053674437
EAN CODE: 8435394779508

FEATURE

- Auto Power Off.
- Transistor hFE 0~1000.
- Diode Open Voltage 3.0V.
- Data Hold.

SPECIFICATIONS

AC Voltage 750V	DC Voltage 1000V	AC Current 10A
DC Current 10A	Resistance 200MΩ	Continuity <70Ω
Capacitance 20μF	Display Counts 2000	

MAIN APPLICATIONS

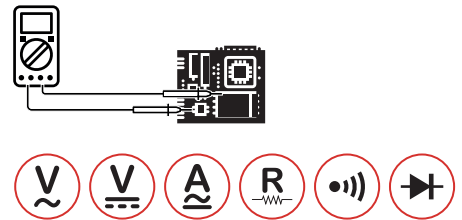
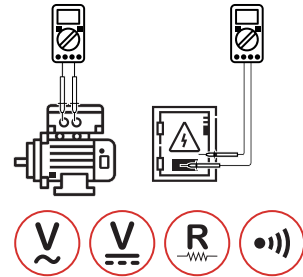
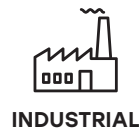
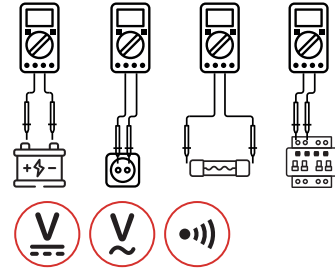

CONTENTS



195×92×55mm
7.7"×3.6"×2.2"
380g/0.83lb



1×9V 6F22
Battery



ACCESSORIES

Test leads
Multi-function socket
Battery



Calibration
Certificate



Quick Start
Guide

PACKAGING INFORMATION



Color Box
L165×W70×H225mm



Carton Box
47×37.5×35.5cm



X 20PCS



MAIN APPLICATIONS

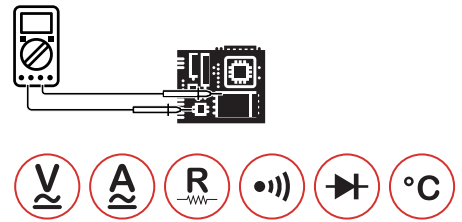
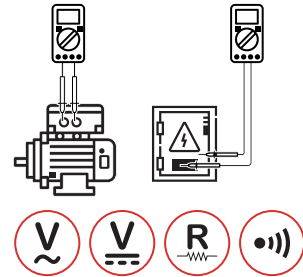
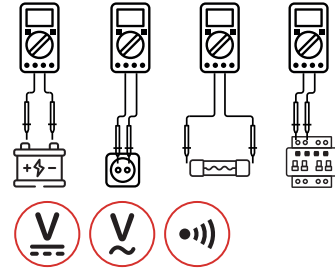

DIGITAL MULTIMETER
MS8264

SKU NO.: MS8264CBGLO
UPC CODE: 810053674444
EAN CODE: 8435394779515

FEATURE

- Auto Power Off.
- Transistor hFE 0~1000.
- Diode Open Voltage 3.0V.
- Data Hold.

SPECIFICATIONS

AC Voltage 750V	DC Voltage 1000V	AC Current 10A
DC Current 10A	Resistance 200MΩ	Continuity <70Ω
Capacitance 20μF	Frequency 20kHz	Display Counts 2000
Temperature -20°C~1000°C		

CONTENTS



195×92×55mm
7.7"×3.6"×2.2"
380g/0.83lb



1×9V 6F22
Battery



ACCESSORIES

Test leads
K type thermocouple
Multi-function socket
Battery



Calibration
Certificate



Quick Start
Guide

PACKAGING INFORMATION



Color Box
L165×W70×H225mm



Carton Box
47×37.5×35.5cm



X 20PCS



DIGITAL MULTIMETER MS8269

SKU NO.: MS8269CBGLO
UPC CODE: 810053674468
EAN CODE: 8435394779539

FEATURE

- Auto Power Off.
- Transistor hFE 0~1000.
- Diode Open Voltage 3.0V.
- Data Hold.

SPECIFICATIONS

AC Voltage 750V	DC Voltage 1000V	AC Current 10A
DC Current 10A	Resistance 20MΩ	Continuity test <70Ω
Capacitance 200μF	Inductance 20H	Display Counts 2000
Temperature -20°C~1000°C		

MAIN APPLICATIONS

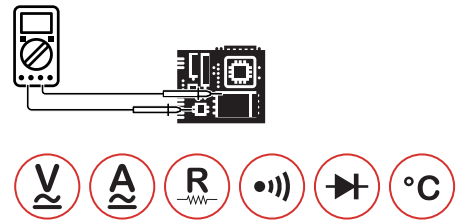
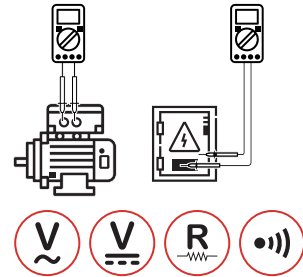
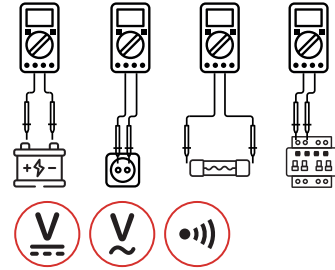

CONTENTS



195×92×55mm
7.7"×3.6"×2.2"
380g/0.83lb



1×9V 6F22
Battery



ACCESSORIES

Test leads
K type thermocouple
Multi-function socket
Battery



Calibration
Certificate



Quick Start
Guide

PACKAGING INFORMATION



Color Box
L165×W70×H225mm



Carton Box
47×37.5×35.5cm



X 20PCS



DIGITAL MULTIMETER
MS8321A

SKU NO.: MS8321ACBGLO
UPC CODE: 810053674475
EAN CODE: 8435394779546

FEATURE

- Manual Ranging.
- Auto Power Off.
- Data Hold.
- Diode Open Voltage 3.0V.

SPECIFICATIONS

AC Voltage 600V	DC Voltage 600V	AC Current 10A
DC Current 10A	Resistance 20MΩ	Continuity <40Ω
Display Counts 2000		

MAIN APPLICATIONS



DOMESTIC

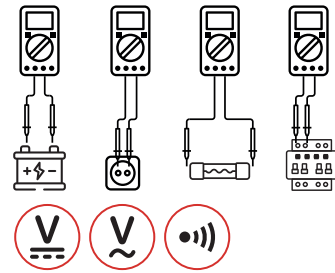

ELECTRONICS

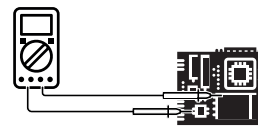

CONTENTS



158×74×36mm
5.8"×2.87"×1.5"
220g/0.48lb



1×9V 6F22
Battery



ACCESSORIES

Test leads
Multi-function socket
Battery



Calibration
Certificate



Quick Start
Guide

PACKAGING INFORMATION



Color Box
L145×W60×H188mm



Carton Box
40×32×31.5cm



X 20PCS



DIGITAL MULTIMETER **MS8321D**

SKU NO.: MS8321DCBGLO
UPC CODE: 810053675342
EAN CODE: 8435394783390

FEATURE

- Manual Ranging.
- Auto Power Off.
- Data Hold.
- Low Battery Display.

SPECIFICATIONS

AC Voltage 750V	DC Voltage 1000V	AC Current 20A
DC Current 20A	Resistance 20MΩ	Continuity <60Ω
Display Counts 2000		

MAIN APPLICATIONS

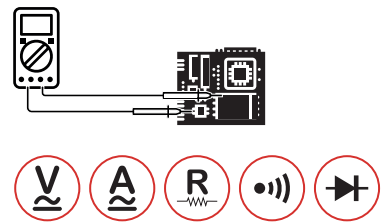
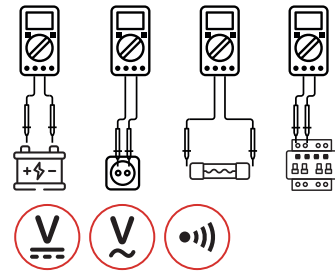

CONTENTS



158×74×36mm
5.8"×2.87"×1.5"
220g/0.48lb



1×9V 6F22
Battery



Test Leads
Battery



Calibration
Certificate

ACCESSORIES



Quick Start
Guide

PACKAGING INFORMATION



Color Box
L145×W60×H188mm



Carton Box
40×32×31.5cm



X 20PCS



DIGITAL MULTIMETER
MY60

SKU NO.: MY60CBGLO
UPC CODE: 810053672426
EAN CODE: 8435394778068

FEATURE

- Auto Power Off.
- Transistor hFE 0~1000.
- Diode Open Voltage 3.0V.
- Data Hold.

SPECIFICATIONS

AC Voltage 750V	DC Voltage 1000V	AC Current 10A
DC Current 10A	Resistance 200MΩ	Capacitance 100μF
Frequency 20kHz	Continuity <50Ω	Display Counts 2000

MAIN APPLICATIONS

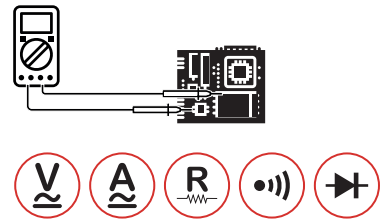
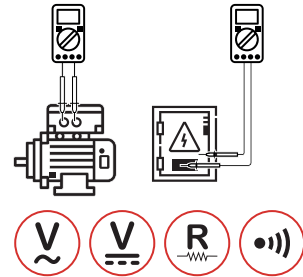
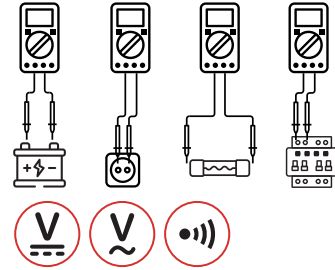

CONTENTS



195×95×55mm
7.67"×3.74"×2.16"
366g/0.8lb



1×9V 6F22
Battery



ACCESSORIES

Test leads
Multi-function socket
Battery



Calibration
Certificate



Quick Start
Guide

PACKAGING INFORMATION



Color Box
L165×W70×H225mm



Carton Box
47×37.5×35.5cm



X 20PCS



DIGITAL MULTIMETER
MY61

SKU NO.: MY61CBGLO
UPC CODE: 810053672419
EAN CODE: 8435394778051

FEATURE

- Auto Power Off.
- Transistor hFE 0~1000.
- Diode Open Voltage 3.0V.
- Data Hold.

SPECIFICATIONS

AC Voltage 750V	DC Voltage 1000V	AC Current 10A
DC Current 10A	Resistance 200Ω	Capacitance 100μF
Frequency 20kHz	Continuity <50Ω	Display Counts 2000

MAIN APPLICATIONS

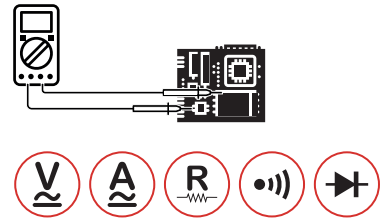
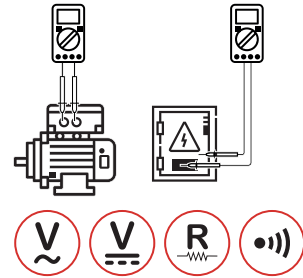
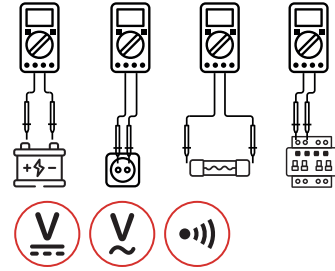

CONTENTS



195×95×55mm
7.67"×3.74"×2.16"
366g/0.8lb



1×9V 6F22
Battery



ACCESSORIES

Test leads
Multi-function socket
Battery



Calibration
Certificate



Quick Start
Guide

PACKAGING INFORMATION



Color Box
L165×W70×H225mm



Carton Box
47×37.5×35.5cm



X 20PCS



MAIN APPLICATIONS

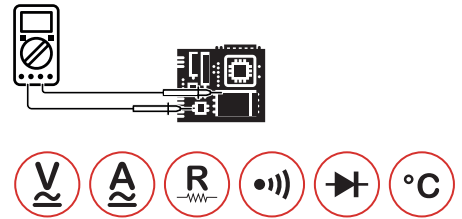
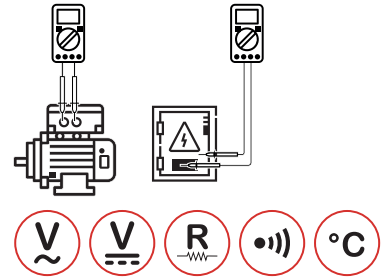
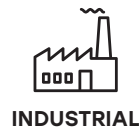
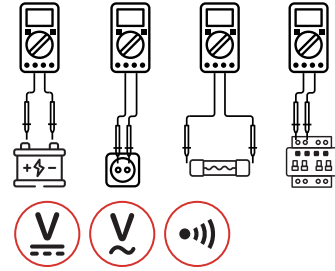

DIGITAL MULTIMETER
MY62

SKU NO.: MY62CBGLO
UPC CODE: 810053672433
EAN CODE: 8435394778075

FEATURE

- Auto Power Off.
- Transistor hFE 0~1000.
- Diode Open Voltage 3.0V.
- Data Hold.

SPECIFICATIONS

AC Voltage 750V	DC Voltage 1000V	AC Current 10A
DC Current 10A	Resistance 200MΩ	Capacitance 100μF
Frequency 20kHz	Continuity <50Ω	Display Counts 2000
Temperature -20°C~1000°C		

CONTENTS



195×95×55mm
7.67"×3.74"×2.16"
366g/0.8lb



1×9V 6F22
Battery



ACCESSORIES

Test leads
K type thermocouple
Multi-function socket
Battery



Calibration
Certificate



Quick Start
Guide

PACKAGING INFORMATION



Color Box
L165×W70×H225mm



Carton Box
47×37.5×35.5cm



X 20PCS



DIGITAL MULTIMETER
MY63

SKU NO.: MY63CBGLO
UPC CODE: 810053674833
EAN CODE: 8435394782003

FEATURE

- Auto Power Off.
- Transistor hFE 0~1000.
- Diode Open Voltage 3.0V.
- Data Hold.

SPECIFICATIONS

AC Voltage 750V	DC Voltage 1000V	AC Current 10A
DC Current 10A	Resistance 200MΩ	Capacitance 100μF
Frequency 20kHz	Continuity <50Ω	Display Counts 2000

MAIN APPLICATIONS

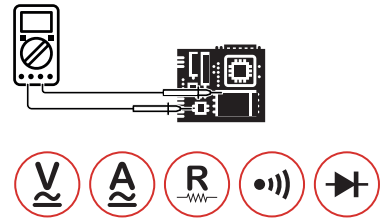
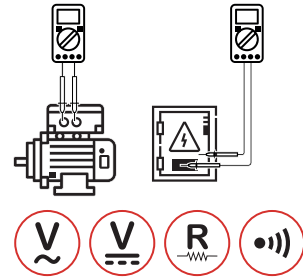
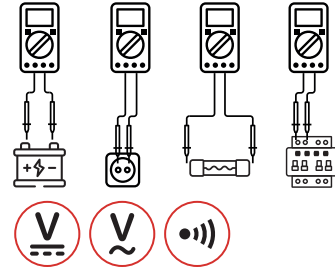

CONTENTS



195×95×55mm
7.67"×3.74"×2.16"
366g/0.8lb



1×9V 6F22
Battery



ACCESSORIES

Test leads
Multi-function socket
Battery



Calibration
Certificate



Quick Start
Guide

PACKAGING INFORMATION



Color Box
L165×W70×H225mm



Carton Box
47×37.5×35.5cm



X 20PCS



DIGITAL MULTIMETER
MY64

SKU NO.: MY64CBGLO
UPC CODE: 810053673324
EAN CODE: 8435394779058

FEATURE

- Auto Power Off.
- Transistor hFE 0~1000.
- Diode Open Voltage 3.0V.
- Data Hold.

SPECIFICATIONS

AC Voltage 750V	DC Voltage 1000V	AC Current 10A
DC Current 10A	Resistance 200MΩ	Capacitance 100μF
Frequency 20kHz	Continuity <50Ω	Display Counts 2000
Temperature -20°C~1000°C		

MAIN APPLICATIONS

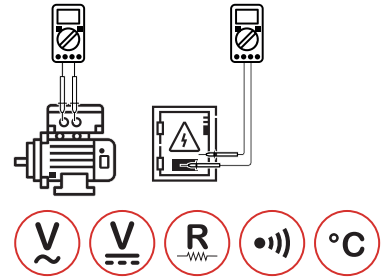
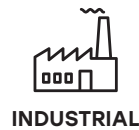
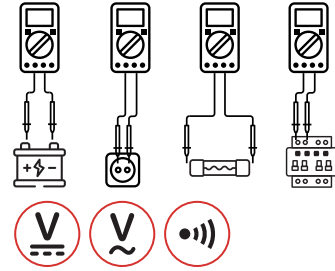

ELECTRONICS

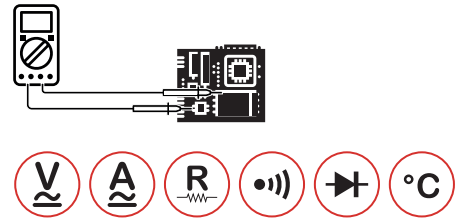

CONTENTS



195×95×55mm
7.67"×3.74"×2.16"
366g/0.8lb



1×9V 6F22
Battery



ACCESSORIES

Test leads
K type thermocouple
Multi-function socket
Battery



Calibration
Certificate



Quick Start
Guide

PACKAGING INFORMATION



Color Box
L165×W70×H225mm



Carton Box
47×37.5×35.5cm



X 20PCS



DIGITAL MULTIMETER
MY65

SKU NO.: MY65CBGLO
UPC CODE: 810053672440
EAN CODE: 8435394778082

FEATURE

- Auto Power Off.
- Transistor hFE 0~1000.
- Diode Open Voltage 3.0V.
- Data Hold.

SPECIFICATIONS

AC Voltage 750V	DC Voltage 1000V	AC Current 10A
DC Current 10A	Resistance 200MΩ	Capacitance 100μF
Frequency 20kHz	Continuity <70Ω	Display Counts 20000

MAIN APPLICATIONS

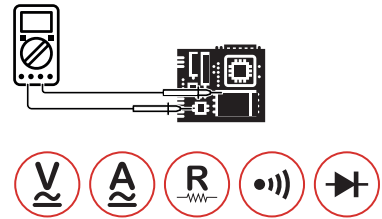
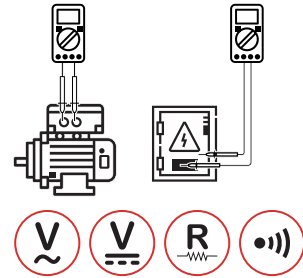
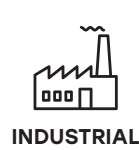
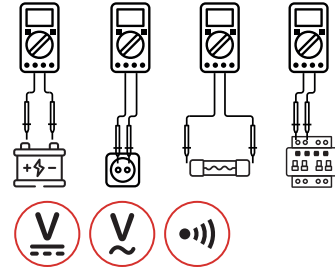

CONTENTS



195×95×55mm
7.67"×3.74"×2.16"
366g/0.8lb



1×9V 6F22
Battery



ACCESSORIES

Test leads
Multi-function socket
Battery



Calibration
Certificate



Quick Start
Guide

PACKAGING INFORMATION



Color Box
L165×W70×H225mm



Carton Box
47×37.5×35.5cm



X 20PCS



DIGITAL MULTIMETER
MY70

SKU NO.: MY70CBGLO
UPC CODE: 810053672280
EAN CODE: 8435394778006

FEATURE

- Auto Power Off.
- Transistor hFE 0~1000.
- Diode Open Voltage 3.0V.
- Data Hold.

SPECIFICATIONS

AC Voltage 600V	DC Voltage 600V	AC Current 10A
DC Current 10A	Resistance 200MΩ	Continuity <50Ω
Display Counts 2000		

MAIN APPLICATIONS

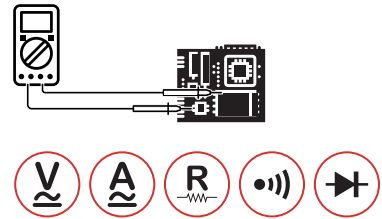
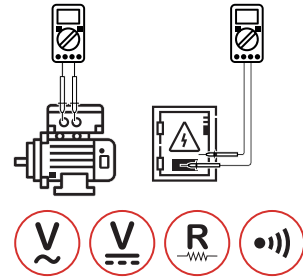
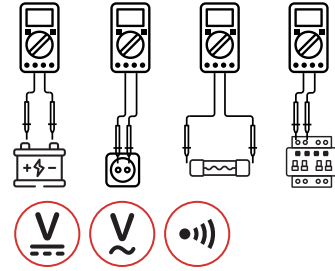

CONTENTS



188×93×50mm
7.4"×3.7"×1.96"
380g/0.84lb



1×9V 6F22
Battery



ACCESSORIES

Test leads
Multi-function socket
Battery



Calibration
Certificate



Quick Start
Guide

PACKAGING INFORMATION



Color Box
L165×W70×H225mm



Carton Box
47×37.5×35.5cm



X 20PCS



DIGITAL MULTIMETER
MY74

SKU NO.: MY74CBGLO
UPC CODE: 810053672297
EAN CODE: 8435394778013

FEATURE

- Auto Power Off.
- Transistor hFE 0~1000.
- Diode Open Voltage 3.0V.
- Data Hold.

SPECIFICATIONS

AC Voltage 600V	DC Voltage 600V	AC Current 10A
DC Current 10A	Resistance 200MΩ	Capacitance 100μF
Frequency 20kHz	Continuity <50Ω	Display Counts 2000
Temperature -20°C~1000°C		

MAIN APPLICATIONS

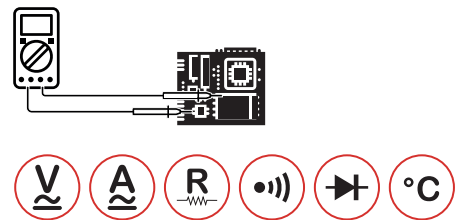
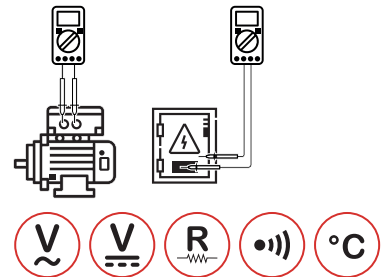
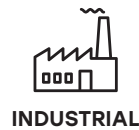
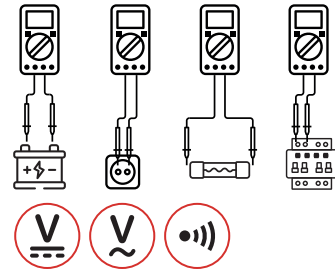

CONTENTS



188×93×50mm
7.4"×3.7"×1.96"
380g/0.84lb



1×9V 6F22
Battery



ACCESSORIES

Test leads
K type thermocouple
Multi-function socket
Battery



Calibration
Certificate



Quick Start
Guide

PACKAGING INFORMATION



Color Box
L165×W70×H225mm



Carton Box
47×37.5×35.5cm



X 20PCS



DIGITAL MULTIMETER
MY75

SKU NO.: MY75CBGLO
UPC CODE: 810053672303
EAN CODE: 8435394778020

FEATURE

- Diode Open Voltage 3.0V.
- Transistor hFE 0~1000.
- Data Hold.
- Auto Power Off.

SPECIFICATIONS

AC Voltage 600V	DC Voltage 600V	AC Current 10A
DC Current 10A	Resistance 200MΩ	Capacitance 200nF
Frequency 20kHz	Continuity <60Ω	Display Counts 20000

MAIN APPLICATIONS

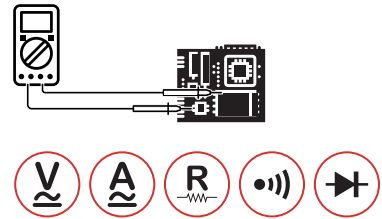
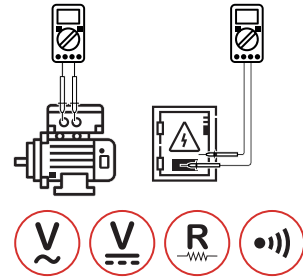
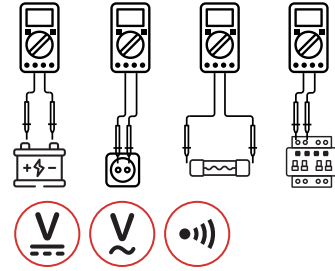

CONTENTS



188×93×50mm
7.4"×3.7"×1.96"
380g/0.84lb



1×9V 6F22
Battery



ACCESSORIES

Test leads
Multi-function socket
Battery



Calibration
Certificate



Quick Start
Guide

PACKAGING INFORMATION



Color Box
L165×W70×H225mm



Carton Box
47×37.5×35.5cm



X 20PCS



DIGITAL MULTIMETER
MS820L

SKU NO.: MS820LCBGLO
UPC CODE: 810053678183
EAN CODE: 8435394787787

FEATURE

- Display 2000 counts.
- Data Hold.
- Auto Power Off.

SPECIFICATIONS

AC Voltage 500V	DC Voltage 500V	DC Current 10A
Resistance 200MΩ	Continuity <50±20Ω	Display Counts 2000

MAIN APPLICATIONS

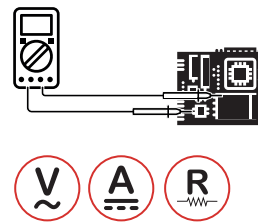
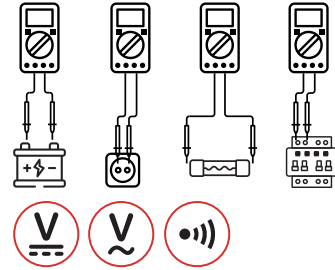

CONTENTS



115x65x30mm
4.5"x2.6"x1.2"
170g/0.37lb



2x1.5V AAA
Batteries



Test Leads
Battery



Calibration
Certificate

ACCESSORIES



Quick Start
Guide

PACKAGING INFORMATION



Color Box
L145xW50xH160mm



Carton Box
53.8x30.8x17.8cm



X 20PCS



DIGITAL MULTIMETER MS8217

SKU NO.: MS8217CBGLO
UPC CODE: 810053673263
EAN CODE: 8435394778990

FEATURE

- Auto & Manual Ranging.
- Auto Power Off.
- Relative Measurement.
- Diode Open Voltage 1.5V.

SPECIFICATIONS

AC Voltage 1000V	DC Voltage 1000V	AC Current 10A
DC Current 10A	Resistance 40MΩ	Capacitance 100uF
Frequency 100kHz	Continuity <50±20Ω	Display Counts 2000
Temperature -55°C~1000°C		

MAIN APPLICATIONS

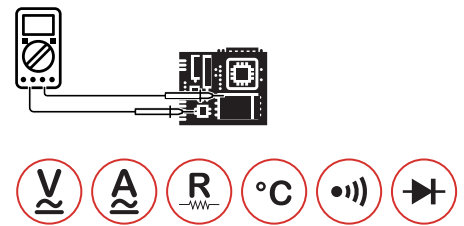
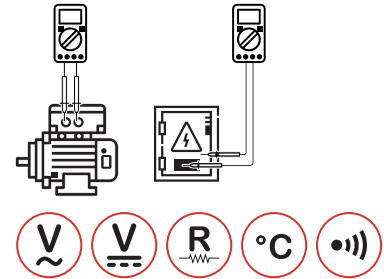
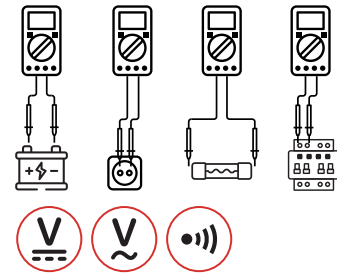

CONTENTS



185×87×53mm
7.28"×3.4"×2.04"
360g/0.79lb



3×1.5V AAA
Batteries



ACCESSORIES

Test leads
K type thermocouple
Multi-function socket
Battery



Calibration
Certificate



Quick Start
Guide

PACKAGING INFORMATION



Color Box
L165×W70×H225mm



Carton Box
47×37.5×35.5cm



X 20PCS



DIGITAL MULTIMETER

MS8221C

SKU NO.: MS8221CCBGLO
 UPC CODE: 810053672310
 EAN CODE: 8435394778457

FEATURE

- Auto & Manual Ranging.
- Auto Power Off.
- Diode Open Voltage 1.5V.

SPECIFICATIONS

AC Voltage 600V	DC Voltage 600V	AC Current 10A
DC Current 10A	Resistance 20MΩ	Capacitance 1000uF
Frequency 400kHz	Continuity <50±20Ω	Display Counts 2000
Temperature -20°C~1000°C		

MAIN APPLICATIONS

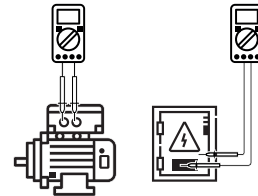
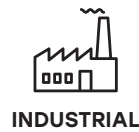
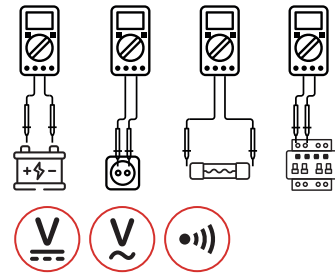

CONTENTS



158×74×32mm
 6.2"×2.9"×1.2"
 250g/0.55lb



3×1.5V AAA
 Battery



ACCESSORIES

Test leads
 K type thermocouple
 Multi-function socket
 Battery



Calibration
 Certificate



Quick Start
 Guide

PACKAGING INFORMATION



Color Box
 L145×W60×H188mm



Carton Box
 40×32×31.5cm



X 20PCS



DIGITAL MULTIMETER

MS8233D

SKU NO.: MS8233DCBGLO
 UPC CODE: 810053673201
 EAN CODE: 8435394778938

FEATURE

- Non-contact Voltage Detection.
- Maximum Measurement.
- Display Backlight.
- Low Battery Display.

SPECIFICATIONS

AC Voltage 600V	DC Voltage 600V	AC Current 10A
DC Current 10A	Resistance 20MΩ	Continuity <60Ω
Display Counts 2000		

MAIN APPLICATIONS

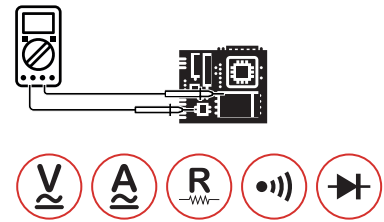
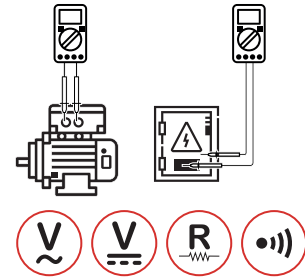
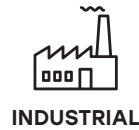
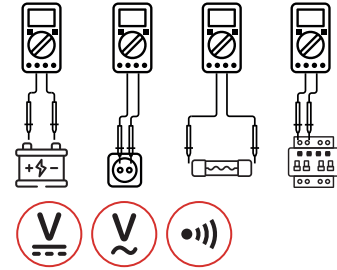

CONTENTS



140×67×30mm
 5.5"×2.6"×1.2"
 112g/0.25lb



1×9V 6F22
 Battery



Test Leads
 Battery

ACCESSORIES



Calibration
 Certificate



Quick Start
 Guide

PACKAGING INFORMATION



Color Box
 L145×W60×H188mm



Carton Box
 40×32×31.5cm



X 20PCS



DIGITAL MULTIMETER
MS8233E

SKU NO.: MS8233ECBGLO
UPC CODE: 810053672259
EAN CODE: 8435394777979

FEATURE

- Non-contact Voltage Detection.
- Maximum Measurement.
- Display Backlight.
- Low Battery Display.

SPECIFICATIONS

AC Voltage 600V	DC Voltage 600V	AC Current 10A
DC Current 10A	Resistance 20MΩ	Continuity <60Ω
Display Counts 2000	Temperature -20°C~1000°C/-4°F~1832°F	

MAIN APPLICATIONS

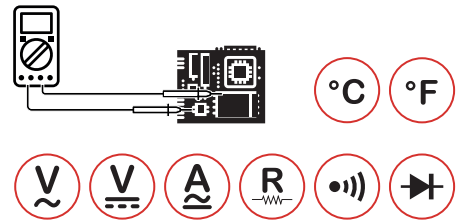
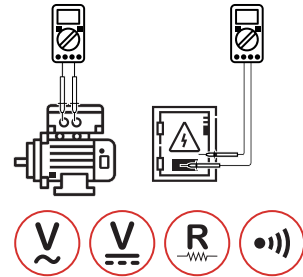
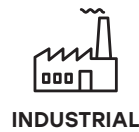
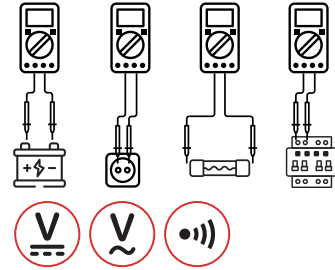

CONTENTS



140×67×30mm
5.5"×2.6"×1.2"
112g/0.25lb



1×9V 6F22
Battery



ACCESSORIES

Test leads
K type thermocouple
Battery



Calibration
Certificate



Quick Start
Guide

PACKAGING INFORMATION



Color Box
L145×W60×H188mm



Carton Box
40×32×31.5cm



X 20PCS



DIGITAL MULTIMETER WITH WIRELESS **MS8238H**

SKU NO.: MS8238HCBGLO
UPC CODE: 810053675335
EAN CODE: 8435394783383

FEATURE

- Auto Power Off.
- True RMS For AC Voltage & AC Current.
- Wireless APP connection.
- Non-Contact Voltage Detector.

SPECIFICATIONS

AC Voltage 600V	DC Voltage 600V	AC Current 10A
DC Current 10A	Resistance 40MΩ	Continuity <50Ω
Display Counts 4000	Temperature -20°C~1000°C/-4°F~1832°F	

MAIN APPLICATIONS

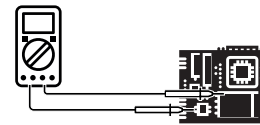
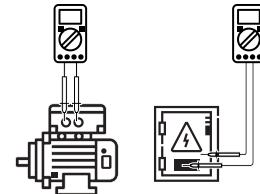
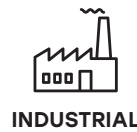
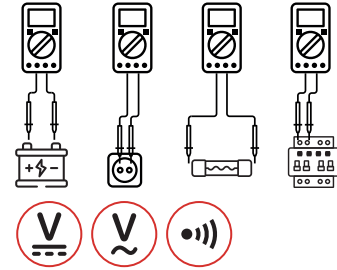

CONTENTS



148×73.5×50mm
5.8"×2.9"×1.96"
241g/0.53lb



1×9V 6F22
Battery



ACCESSORIES

Test leads
K type thermocouple
Battery



Calibration
Certificate



Quick Start
Guide

PACKAGING INFORMATION



Color Box
L145×W60×H188mm



Carton Box
40×32×31.5cm



X 20PCS



DIGITAL MULTIMETER MS8239C

SKU NO.: MS8239CCBGLO
UPC CODE: 810053672266
EAN CODE: 8435394777986

FEATURE

- Auto & Manual Ranging.
- Auto Power Off.
- Diode Open Voltage 1.5V.
- Data Hold.

SPECIFICATIONS

AC Voltage 600V	DC Voltage 600V	AC Current 10A
DC Current 10A	Resistance 40MΩ	Continuity <50±20Ω
Frequency 10kHz	Temperature -20°C~1000°C/-4°F~1832°F	
Display Counts 4000		

MAIN APPLICATIONS

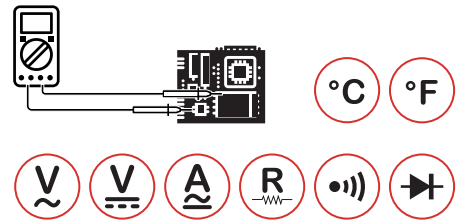
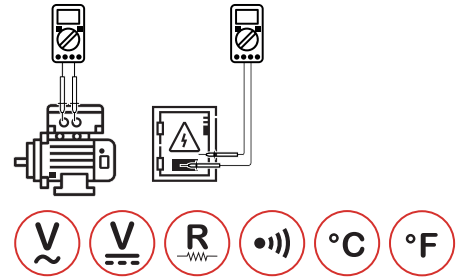
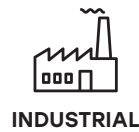
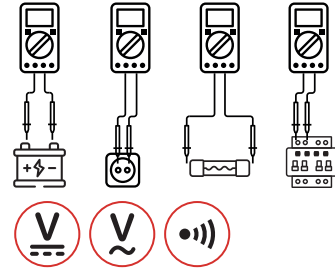

CONTENTS



150×74×41mm
5.9"×2.9"×1.6"
202g/0.44lb



2×1.5V AAA
Batteries



ACCESSORIES

Test leads
K type thermocouple
Battery



Calibration
Certificate



Quick Start
Guide

PACKAGING INFORMATION



Color Box
L145×W60×H188mm



Carton Box
40×32×31.5cm



X 20PCS



DIGITAL MULTIMETER

MS8251A

SKU NO.: MS8251ACBGLO
 UPC CODE: 810053673157
 EAN CODE: 8435394778884

FEATURE

- Auto & Manual Ranging.
- Auto Power Off.
- True RMS.
- Non-Contact Voltage Detector.

SPECIFICATIONS

AC Voltage 1000V	DC Voltage 1000V	AC Current 10A
DC Current 10A	Resistance 66MΩ	Continuity <50±20Ω
Capacitance 66mF	Frequency 66MHz	Display Counts 6600

MAIN APPLICATIONS

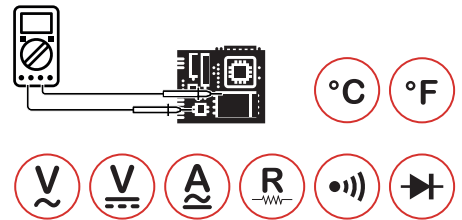
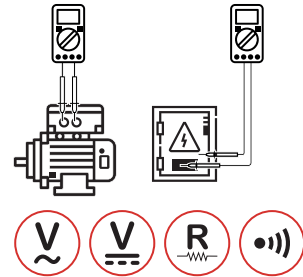
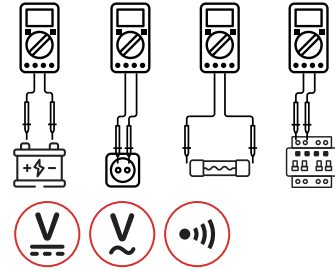

CONTENTS



175×85×52mm
 6.89"×3.3"×2.1"
 420g/0.92lb



1×9V 6F22
 Battery



ACCESSORIES

Test leads
 K type thermocouple
 Multi-function socket
 Carrying strap
 Battery



Calibration
 Certificate



Quick Start
 Guide

PACKAGING INFORMATION



Color Box
 L165×W70×H225mm



Carton Box
 47×37.5×35.5cm



X 20PCS



DIGITAL MULTIMETER
MS8251B

SKU NO.: MS8251BCBGLO
UPC CODE: 810053672686
EAN CODE: 8435394778327

FEATURE

- Auto & Manual Ranging.
- Auto Power Off.
- Relative Measurement.
- Non-Contact Voltage Detector.

SPECIFICATIONS

AC Voltage 1000V	DC Voltage 1000V	AC Current 10A
DC Current 10A	Resistance 66MΩ	Continuity <50±20Ω
Capacitance 66mF	Frequency 10kHz	Display Counts 6600
Temperature 0°C~1000°C/32°F~1832°F		

MAIN APPLICATIONS

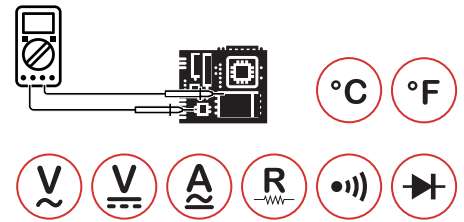
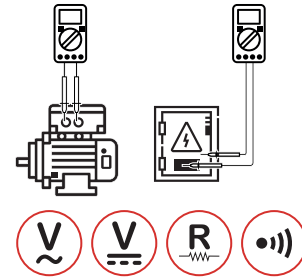
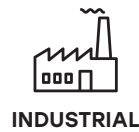
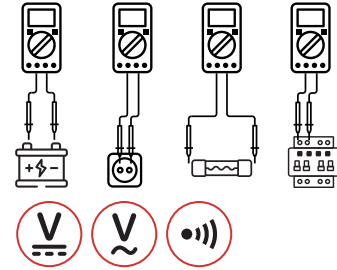

CONTENTS



175×85×52mm
6.9"×3.3"×2.1"
420g/0.92lb



1×9V 6F22
Battery



ACCESSORIES

Test leads
K type thermocouple
Multi-function socket
Carrying strap
Battery



Calibration
Certificate



Quick Start
Guide

PACKAGING INFORMATION



Color Box
L165×W70×H225mm



Carton Box
47×37.5×35.5cm



X 20PCS



MAIN APPLICATIONS

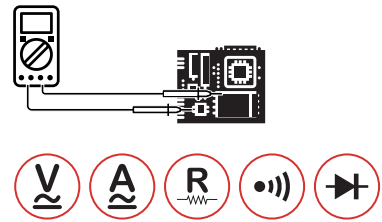
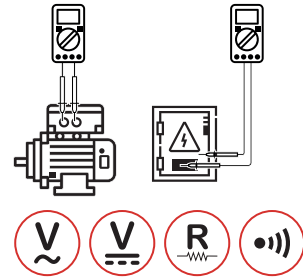
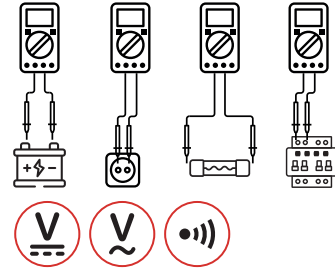

DIGITAL MULTIMETER
MS8268

SKU NO.: MS8268CBGLO
UPC CODE: 810053672709
EAN CODE: 8435394778341

FEATURE

- Auto Ranging.
- Auto Power Off.
- Sound & Light Warning.
- Relative Measurement.

SPECIFICATIONS

AC Voltage 750V	DC Voltage 1000V	AC Current 10A
DC Current 10A	Resistance 40MΩ	Continuity <70Ω
Capacitance 200μF	Frequency 200kHz	Display Counts 4000

CONTENTS

- 195×92×55mm
7.7"×3.6"×2.2"
400g/0.9lb
- 3×1.5V AAA Batteries
- Test leads
Multi-function socket
Battery
- Calibration Certificate
- Quick Start Guide

PACKAGING INFORMATION

- Color Box**
L165×W70×H225mm
- Carton Box**
47×37.5×35.5cm
- X 20PCS**



DIGSMART DIGITAL MULTIMETER
MS8301D

SKU NO.: MS8301DCBGLO
UPC CODE: 810053672273
EAN CODE: 8435394777993

FEATURE

- Auto Ranging.
- Auto Power Off.
- Dual Display.
- Continuity Buzzer.

SPECIFICATIONS

AC Voltage 600V	DC Voltage 600V	Resistance 10MΩ
Frequency 3kHz	Continuity <40Ω	Display Counts 6000

MAIN APPLICATIONS

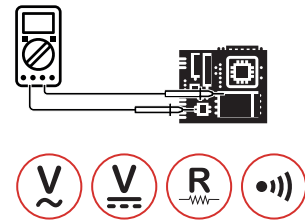
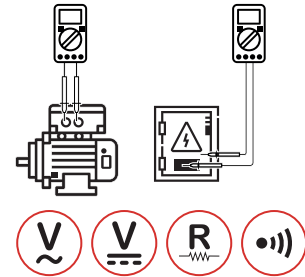
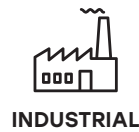
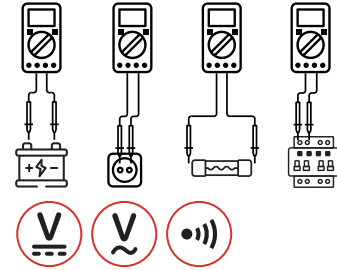

CONTENTS



150×74×48mm
5.9"×2.9"×1.7"
220g/0.48lb



2×1.5V AAA
Batteries



Test Leads
Battery



Calibration
Certificate

ACCESSORIES



Quick Start
Guide

PACKAGING INFORMATION



Color Box
L145×W60×H188mm



Carton Box
40×32×31.5cm



X 20PCS



DIGITAL MULTIMETER

MS8332C

SKU NO.: MS8332CCBGLO
 UPC CODE: 810053674857
 EAN CODE: 8435394782065

FEATURE

- Display 4000 Counts.
- Diode Open Voltage 1.5v.
- Low Battery Display.

SPECIFICATIONS

AC Voltage 600V	DC Voltage 600V	AC Current 400mA
DC Current 400mA	Resistance 40MΩ	Continuity <50±20Ω
Capacitance 100μF	Frequency 5MHz	Display Counts 4000

MAIN APPLICATIONS

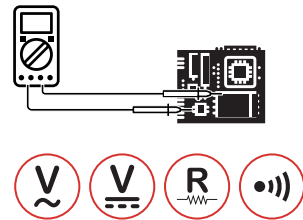
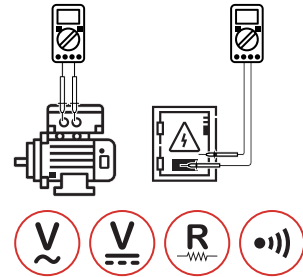
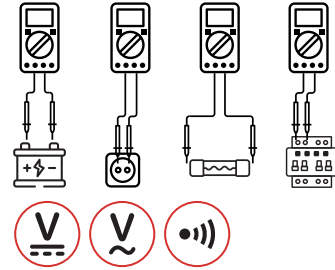

CONTENTS



110×58×33mm
 4.4"×2.3"×1.3"
 150g/0.25lb



2×1.5V AAA
 Batteries



Test Leads
 Battery



Calibration
 Certificate

ACCESSORIES



Quick Start
 Guide

PACKAGING INFORMATION



Color Box
 L145×W60×H188mm



Carton Box
 40×32×31.5cm



X 20PCS



DIGITAL MULTIMETER MS8340A

SKU NO.: MS8340ACBGLO
UPC CODE: 810053675359
EAN CODE: 8435394783000

FEATURE

- Auto & Manual Ranging.
- Auto Power Off.
- Relative Measurement.
- Low Pass Filter 1kHz.

SPECIFICATIONS

AC Voltage 750V	DC Voltage 1000V	AC Current 10A
DC Current 10A	Resistance 60MΩ	Continuity <50±20Ω
Capacitance 400μF	Frequency 10MHz	Display Counts 6000
Temperature -10°C~700°C/-14°F~1292°F		

MAIN APPLICATIONS

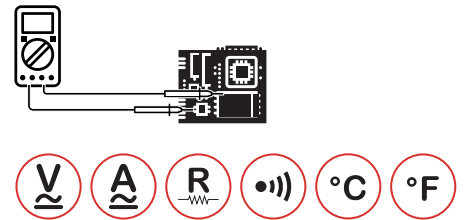
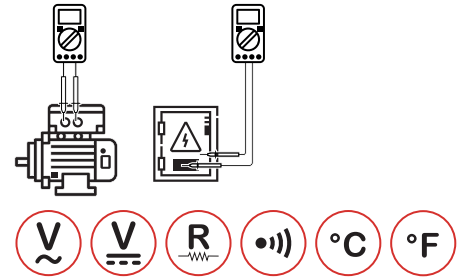
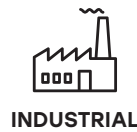
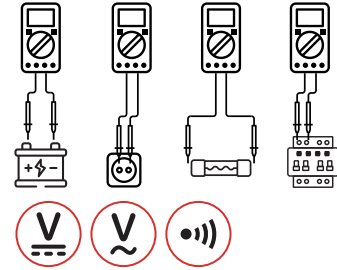

CONTENTS



205x102x58mm
8.1"x4.0"x2.2"
390g/0.86lb



4x1.5V AA
Batteries



ACCESSORIES

Test leads
K type thermocouple
Multi-function socket
Battery



Calibration
Certificate



Quick Start
Guide

PACKAGING INFORMATION



Color Box
L173xW85xH235mm



Carton Box
49x45x37.2cm



X 20PCS



MAIN APPLICATIONS

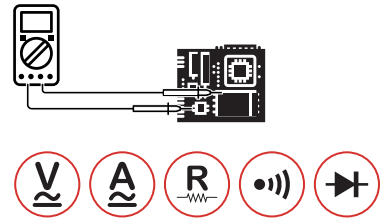
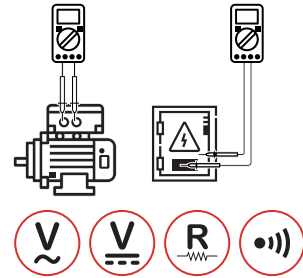
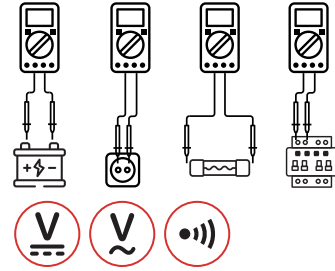

DIGITAL MULTIMETER
MY68

SKU NO.: MY68CBGLO
UPC CODE: 810053672457
EAN CODE: 8435394778099

FEATURE

- Auto Power Off.
- Transistor hFE 0~1000.
- Diode Open Voltage 3.0V.
- Data Hold.

SPECIFICATIONS

AC Voltage 750V	DC Voltage 1000V	AC Current 10A
DC Current 400mA	Resistance 40MΩ	Capacitance 200μF
Frequency 100kHz	Continuity <50Ω	Display counts 4000

CONTENTS



189×91×31.5mm
7.67"×3.6"×1.24"
310g/0.5lb



1×9V 6F22
Battery



Test Leads
Battery

ACCESSORIES



Calibration
Certificate



Quick Start
Guide

PACKAGING INFORMATION



Color Box
L165×W70×H225mm



Carton Box
47×37.5×35.5cm



X 20PCS



DIGITAL MULTIMETER
MY78

SKU NO.: MY78CBGLO
UPC CODE: 810053674550
EAN CODE: 8435394779621

FEATURE

- Auto & Manual Ranging.
- Relative Measurement.
- Diode Open Voltage 1.5V.
- Transistor hFE 0~1000.

SPECIFICATIONS

AC Voltage 600V	DC Voltage 600V	AC Current 10A
DC Current 10A	Resistance 40MΩ	Capacitance 200μF
Frequency >200kHz	Continuity <50±20Ω	Display Counts 4000

MAIN APPLICATIONS

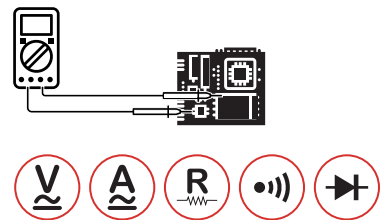
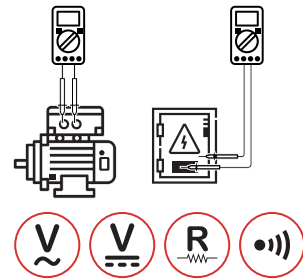
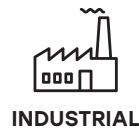
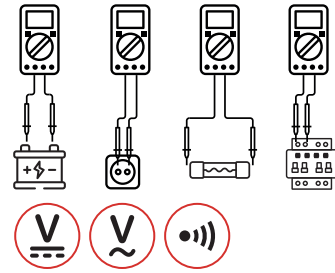

CONTENTS



189×91×31.5mm
7.67"×3.6"×1.24"
420g/0.92lb



1×9V 6F22
Battery



ACCESSORIES

Test leads
Multi-function socket
Battery



Calibration
Certificate



Quick Start
Guide

PACKAGING INFORMATION



Color Box
L165×W70×H225mm



Carton Box
47×37.5×35.5cm



X 20PCS



POCKET DIGITAL MULTIMETER
M300

SKU NO.: M300CBGLO
UPC CODE: 810053672082
EAN CODE: 8435394777818

FEATURE

- Pocket format that facilitates product portability.
- Test leads integrated which facilitates its use and storage.

SPECIFICATIONS

AC Voltage 600V	DC Voltage 600V	DC Current 200mA
Resistance 2MΩ	Display Counts 2000	Continuity <50±20Ω

MAIN APPLICATIONS

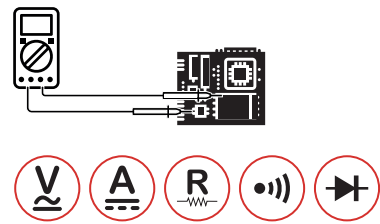
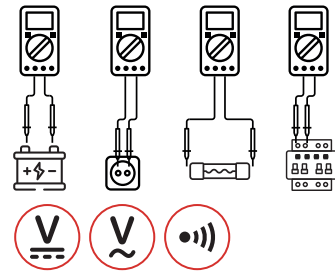

CONTENTS



120×70×18mm
4.7"×2.75"×0.7"
110g/0.23lb



1x12V A23S
Battery



Test leads
Carry bag



Calibration
Certificate

ACCESSORIES



Quick Start
Guide

PACKAGING INFORMATION



Color Box
L95xW35xH154mm



Carton Box
37x32.8x21.5cm



X 40PCS



MAIN APPLICATIONS

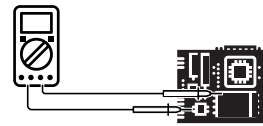
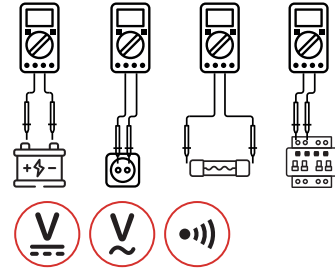

POCKET DIGITAL MULTIMETER
M320

SKU NO.: M320CBGLO
UPC CODE: 810053674048
EAN CODE: 8435394779119

FEATURE

- Auto Ranging.
- Auto Power Off.
- Diode Open Voltage 1.5V.
- Data Hold.

SPECIFICATIONS

AC Voltage 600V	DC Voltage 600V	AC Current 400mA
DC Current 400mA	Resistance 40MΩ	Frequency 100kHz
Display Counts 4000	Continuity <50±20Ω	

CONTENTS



120×70×18mm
4.7"×2.75"×0.7"
110g/0.23lb



2×1.5V 357A(LR44)
Batteries



Test leads
Carry bag

ACCESSORIES



Calibration
Certificate



Quick Start
Guide

PACKAGING INFORMATION



Color Box
L95xW35xH154mm



Carton Box
37x32.8x21.5cm



X 40PCS



POCKET DIGITAL MULTIMETER
MS8333A

SKU NO.: MS8333ACBGLO
UPC CODE: 810053674482
EAN CODE: 8435394779553

FEATURE

- Auto Ranging.
- Auto Power Off.
- True RMS For AC Voltage & AC Current.
- Non-Contact Voltage Detector.

SPECIFICATIONS

AC Voltage 600V	DC Voltage 600V	AC Current 600mA
DC Current 600mA	Resistance 60MΩ	Continuity <50±20Ω
Capacitance 600uF	Frequency 10kHz	Display Counts 6000

MAIN APPLICATIONS

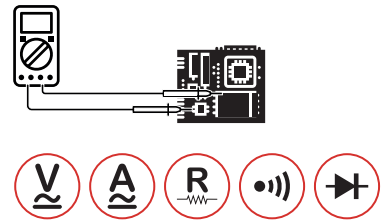
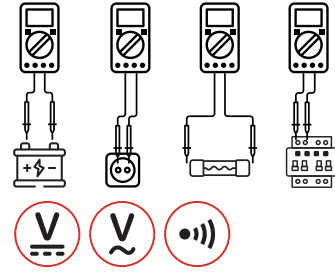

CONTENTS



122×62×44mm
4.8"×2.44"×1.73"
186g/0.4lb



2×1.5V AAA
Batteries



Test leads
Battery



Calibration
Certificate

ACCESSORIES



Quick Start
Guide

PACKAGING INFORMATION



Color Box
L145×W60×H188mm



Carton Box
40×32×31.5cm



X 20PCS



MAIN APPLICATIONS



DOMESTIC

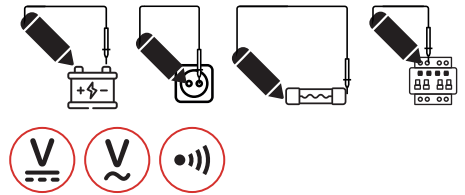

ELECTRONICS

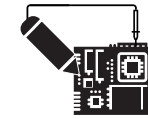

PEN-TYPE DIGITAL MULTIMETER
MS8211

SKU NO.: MS8211CBGLO
UPC CODE: 810053673010
EAN CODE: 8435394778976

FEATURE

- Auto & Manual Ranging.
- Auto Power Off.
- Diode Open Voltage 1.5V.
- Maximum Value Hold.

SPECIFICATIONS

AC Voltage 600V	DC Voltage 600V	Resistance 20MΩ
Continuity <50±20Ω	Display Counts 2000	

CONTENTS



208×38×29mm
8.26"×1.5"×1.1"
110g/0.24lb



2×1.5V AAA
Batteries



ACCESSORIES

Test leads
Alligator Clips
Carry bag
Battery



Calibration
Certificate



Quick Start
Guide

PACKAGING INFORMATION



Color Box
L85×W45×H220mm



Carton Box
46×26×36cm



X 40PCS



PEN-TYPE DIGITAL MULTIMETER
MS8211D

SKU NO.: MS8211DCBGLO
UPC CODE: 810053672655
EAN CODE: 8435394778747

FEATURE

- Auto & Manual Ranging.
- Auto Power Off.
- Diode Open Voltage 1.5V.
- Maximum Value Hold.

SPECIFICATIONS

AC Voltage 600V	DC Voltage 600V	AC Current 200mA
DC Current 200mA	Resistance 20MΩ	Continuity <50±20Ω
Display Counts 2000		

MAIN APPLICATIONS

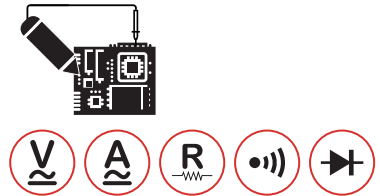
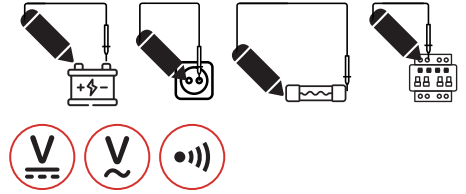

CONTENTS



208×38×29mm
8.26"×1.5"×1.1"
110g/0.24lb



2×1.5V AAA
Batteries



ACCESSORIES

Test leads
Alligator Clips
Carry bag
Battery



Calibration
Certificate



Quick Start
Guide

PACKAGING INFORMATION



Color Box
L85×W45×H220mm



Carton Box
46×26×36cm



X 40PCS



PEN-TYPE DIGITAL MULTIMETER
MS8212A

SKU NO.: MS8212ACBGLO
UPC CODE: 810053673034
EAN CODE: 8435394778761

FEATURE

- Auto & Manual Ranging.
- Auto Power Off.
- Diode Open Voltage 1.5V.
- Maximum Value Hold.

SPECIFICATIONS

AC Voltage 600V	DC Voltage 600V	AC Current 200mA
DC Current 200mA	Resistance 20MΩ	Continuity <50±20Ω
Display Counts 2000		

MAIN APPLICATIONS

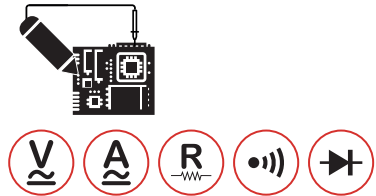
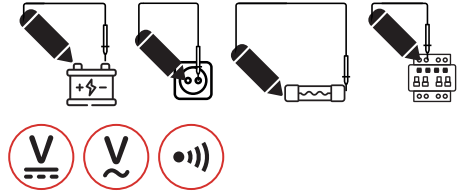

CONTENTS



238×43×29mm
9.37"×1.7"×1.1"
112g/0.28lb



2×1.5V AAA
Batteries



ACCESSORIES

Test leads
Alligator Clips
Carry bag
Battery



Calibration
Certificate



Quick Start
Guide

PACKAGING INFORMATION



Color Box
L85×W45×H236mm



Carton Box
49×28×37cm



X 40PCS



DIGITAL MULTIMETER
MS8223A

SKU NO.: MS8223ACBGLO
UPC CODE: 810053672211
EAN CODE: 8435394777931

FEATURE

- Auto & Manual Ranging.
- Auto Power Off.
- Diode Open Voltage 1.5V.
- Maximum Value Hold.

SPECIFICATIONS

AC Voltage 600V	DC Voltage 600V	AC Current 200mA
DC Current 200mA	Resistance 20MΩ	Continuity <50Ω
Display Counts 2000		

MAIN APPLICATIONS

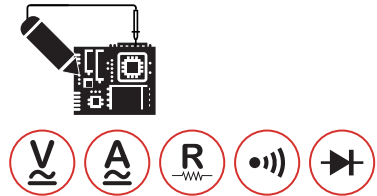
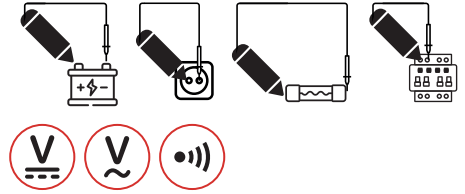

CONTENTS



225×52×40mm
8.86"×2.0"×1.58"
138g/0.3lb



2×1.5V AAA
Batteries



ACCESSORIES

Test leads
Alligator Clips
Carry bag
Battery



Calibration
Certificate



Quick Start
Guide

PACKAGING INFORMATION



Color Box
L85×W50×H236mm



Carton Box
49×28×37cm



X 40PCS



TRUE RMS BENCHTOP MULTIMETER
MS8040

SKU NO.: MS8040CBGLO
UPC CODE: 810053672631
EAN CODE: 8435394778273

FEATURE

- Auto & Manual Ranging.
- True RMS for AC Voltage & AC Current.
- Low Pass Filter (1kHz) for AC Voltage & AC Current.

SPECIFICATIONS

AC Voltage 750V	DC Voltage 1000V	AC Current 10A
DC Current 10A	Resistance 200MΩ	Capacitance 20mF
Display Counts 22000		

MAIN APPLICATIONS

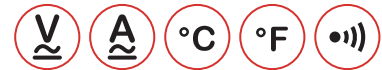
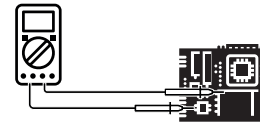

CONTENTS

- 238x230x83mm
9.4"x9.1x3.3"
1500g/3.4lb
- 220V/110V AC
(50~60Hz)
- Test Leads
K Type Thermocouple
Multi-function socket
RS232C Cable
Power cord
Software CD
Carrying strap
- Calibration Certificate
- Quick Start Guide

PACKAGING INFORMATION





- Color Box**
L300xW110xH280mm
- Carton Box**
58.5x32x29.5cm
- X 5PCS**

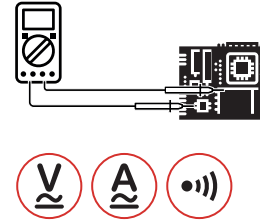

MAIN APPLICATIONS



CONTENTS

-  350x240x100mm
13.8"x9.5"x3.9"
2500g/5.5lb
-  220V/110V AC
-  **ACCESSORIES**
Test leads
Alligator clip
Power cord
RS232C cable
Software CD
Carry case
-  Calibration Certificate
-  Quick Start Guide

TRUE RMS BENCHTOP MULTIMETER
MS8050

SKU NO.: MS8050CBGLO
UPC CODE: 810053674390
EAN CODE: 8435394779461



FEATURE

- True RMS.
- dBm Measurement.
- Relative Measurement.
- Diode Open Voltage 3.3V.

SPECIFICATIONS

AC Voltage 1000V	DC Voltage 1000V	AC Current 10A
DC Current 10A	Resistance 50MΩ	Capacitance 5000μF
Display Counts 53000		

PACKAGING INFORMATION

-  **Color Box**
L465xW140xH320mm
-  **Carton Box**
48.5x30x35cm
-  **X 2PCS**



DIGITAL INSULATION MULTIMETER **MS5208**

SKU NO.: MS5208CBGLO
UPC CODE: 810053673065
EAN CODE: 8435394778792

FEATURE

- Auto & Manual Ranging.
- Auto Power Off.
- True RMS For AC Voltage & AC Current.
- DAR/PI Mod.

SPECIFICATIONS

AC Voltage 750V	DC Voltage 1000V	AC Current 400mA
DC Current 400mA	DC Output 1000V	Resistance 66MΩ
Capacitance 66mF	Frequency 10kHz	Continuity <30Ω
Display Counts 6600	Temperature -30°C~1300°C / -22°F~2372°F	

MAIN APPLICATIONS

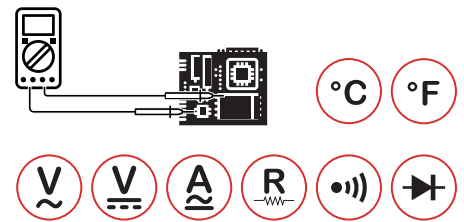
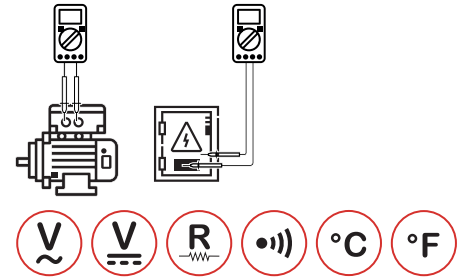
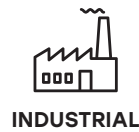
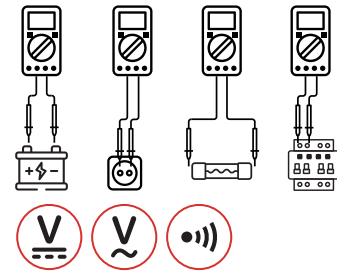

CONTENTS



205x102x58mm
8.1"x4.0"x2.3"
390g/0.86lb



4x1.5V AA
Batteries



ACCESSORIES

Test Leads
Test Clips
K Type Thermocouple
Multi-function socket
Carry Bag
Battery



Calibration
Certificate



Quick Start
Guide

PACKAGING INFORMATION



Color Box
L172xW80xH255mm



Carton Box
53x44.5x37cm



X 20PCS



DIGITAL MULTIMETER WITH ENVIRONMENT 4 IN 1

MS8209

SKU NO.: MS8209CBGLO
 UPC CODE: 810053672648
 EAN CODE: 8435394778280

FEATURE

- Auto & Manual Ranging.
- Auto Power Off.
- Diode Open Voltage 1.5V.
- Relative Measurement.

SPECIFICATIONS

AC Voltage 600V	DC Voltage 600V	AC Current 10A
DC Current 10A	Resistance 40MΩ	Capacitance 200μF
Frequency >200kHz	Continuity <40Ω	Display Counts 4000
Temperature -20°C~1000°C		

MAIN APPLICATIONS

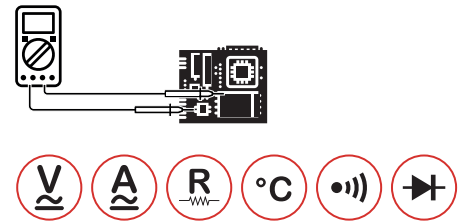
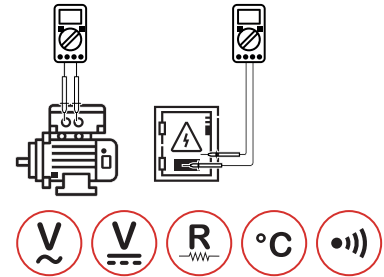
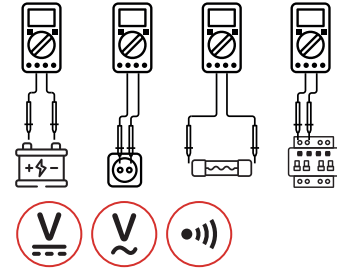

CONTENTS



158×78×39mm
 6.2"×3.1"×1.5"
 260g/0.55lb



1×9V 6F22
 Battery



ACCESSORIES

Test leads
 K type thermocouple
 Carry bag
 Battery



Calibration
 Certificate



Quick Start
 Guide

PACKAGING INFORMATION



Color Box
 L188×W88×H264mm



Carton Box
 55×48.5×39.5cm



X 20PCS



**DIGITAL MULTIMETER WITH ENVIRONMENT
5 IN 1**

MS8229

SKU NO.: MS8229CBAGLO
UPC CODE: 810053672327
EAN CODE: 8435394778433

FEATURE

- Hinged Bracket Facilitate Table Work.
- Auto-Ranging, Relative, Humidity, Luminosity & Sound level.
- For Professional Use.

SPECIFICATIONS

AC Voltage 750V	DC Voltage 1000V	AC Current 10A
DC Current 10A	Resistance 40MΩ	Capacitance 100uF
Frequency >200kHz	Continuity <50±20Ω	Display Counts 4000
Temperature -20°C~1000°C/-4°F~1832°F		

MAIN APPLICATIONS

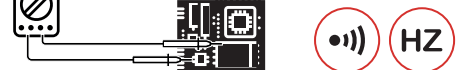
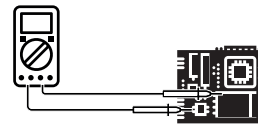
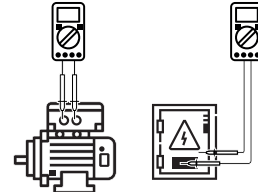
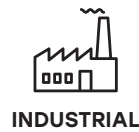
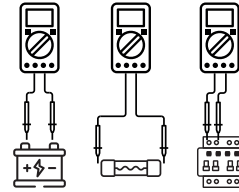

CONTENTS



195×92×55mm
7.7"×3.6"×2.2"
390g/0.86lb



3×1.5V AAA
Batteries



ACCESSORIES

Test leads
K type thermocouple
Battery



Calibration
Certificate



Quick Start
Guide

PACKAGING INFORMATION



Color Box
L165×W70×H225mm



Carton Box
47×37.5×35.5cm



X 20PCS



**DIGITAL MULTIMETER WITH LAN/PHONE/
TONE TESTER**

MS8236

SKU NO.: MS8236CBGLO
UPC CODE: 810053673003
EAN CODE: 8435394778624

FEATURE

- Auto & Manual Ranging.
- Auto Power Off.
- Non-Contact Voltage Detector.
- Diode Open Voltage 1.7V.

SPECIFICATIONS

AC Voltage 600V	DC Voltage 600V	AC Current 10A
DC Current 10A	Resistance 20MΩ	Continuity <70Ω
Display counts 2000		

MAIN APPLICATIONS

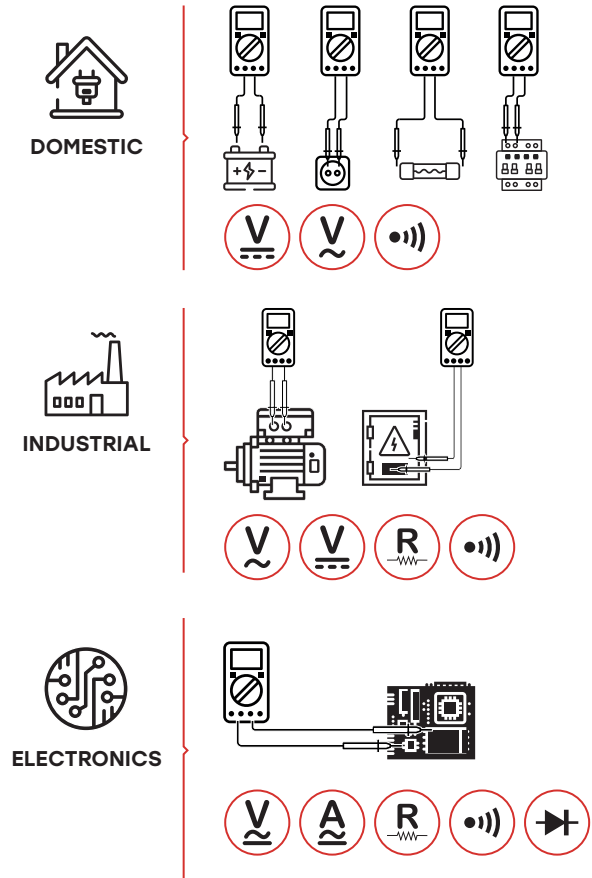

CONTENTS

	MS8236: 195x92x55mm 7.7"x3.6"x2.2" 470g/1.04lb		MS6812R: 238x43x26mm 9.4"x1.7"x1.0"
	Test leads Detection connect line Battery		2x9V 6F22 Batteries
	Calibration Certificate		Quick Start Guide

PACKAGING INFORMATION

	Color Box L188xW88xH264mm		Carton Box 55x48.5x39.5mm		X 40PCS
--	-------------------------------------	--	-------------------------------------	--	----------------



DIGITAL MULTIMETER (ENGINE ANALYZER)
MS8239D

SKU NO.: MS8239DCBGLO
UPC CODE: 810053672983
EAN CODE: 8435394778716

FEATURE

- Auto & Manual Ranging.
- Auto Power Off.
- Diode Open Voltage 2.7V.
- Maximum Measurement.

SPECIFICATIONS

AC Voltage 600V	DC Voltage 600V	AC Current 10A
DC Current 10A	Resistance 40MΩ	Continuity <50Ω
Display Counts 2000		

MAIN APPLICATIONS

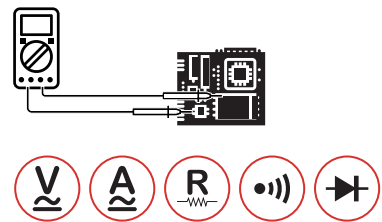
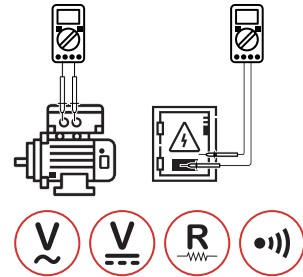
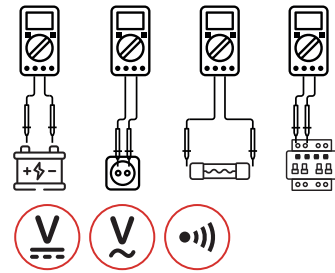

CONTENTS



150×74×41mm
5.9"×2.9"×1.6"
202g/0.44lb



2×1.5V AAA
Batteries



Test leads
Battery

ACCESSORIES



Calibration
Certificate



Quick Start
Guide

PACKAGING INFORMATION



Color Box
L145×W60×H188mm



Carton Box
40×32×31.5cm



X 20PCS



MAIN APPLICATIONS

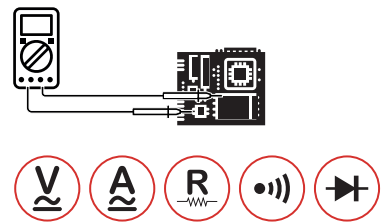
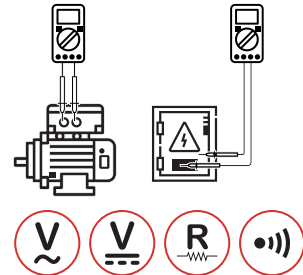
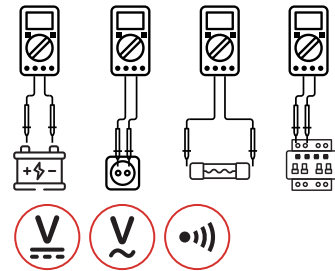

DIGITAL MULTIMETER
MS8265

SKU NO.: MS8265CBGLO
UPC CODE: 810053674772
EAN CODE: 8435394779836

FEATURE

- Auto Power Off.
- Sound & Light Warning.
- Transistor hFE 0~1000.
- Diode Open Voltage 3.0V.

SPECIFICATIONS

AC Voltage 750V	DC Voltage 1000V	AC Current 10A
DC Current 10A	Resistance 200MΩ	Continuity <70Ω
Capacitance 200μF	Frequency 20kHz	Display Counts 20000

CONTENTS



195×92×55mm
7.7"×3.6"×2.2"
400g/0.9lb



1×9V 6F22
Battery



ACCESSORIES

Test leads
Multi-function socket
Battery



Calibration
Certificate



Quick Start
Guide

PACKAGING INFORMATION



Color Box
L165×W70×H225mm



Carton Box
47×37.5×35.5cm



X 20PCS

DIGITAL CLAMP METERS

AC CURRENT | AC/DC CURRENT | LEAKAGE | POWER
SPECIAL APPLICATION





MAIN APPLICATIONS

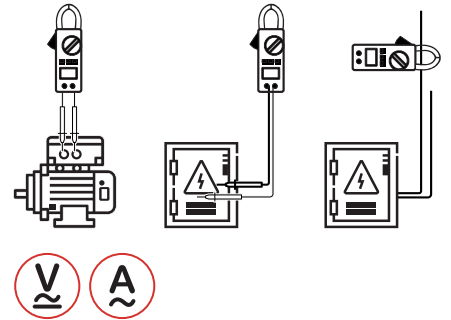
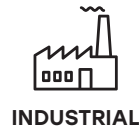
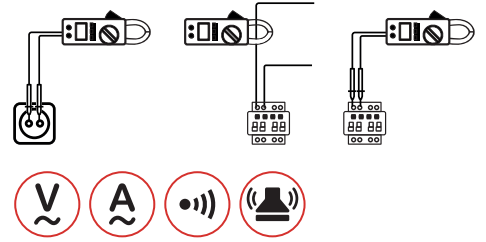

DIGITAL AC ELECTRICAL TESTER
M266

SKU NO.: M266CBGLO
UPC CODE: 810053673287
EAN CODE: 8435394779010

FEATURE

- Data Hold.
- Low Battery Display.

SPECIFICATIONS

AC Voltage 750V	DC Voltage 1000V	AC Current 1000A
Resistance 20kΩ	Display Counts 2000	Continuity <100Ω
Jaw Opening 50mm/2.0"		

CONTENTS



235×96×46mm
9.25"×3.8"×1.8"
268g/0.59lb



1×9V 6F22
Battery



Test Leads
Carry bag
Battery



Calibration
Certificate



Quick Start
Guide

PACKAGING INFORMATION



Color Box
L130×W63×H255mm



Carton Box
53×34×28.5cm



X20PCS



MAIN APPLICATIONS

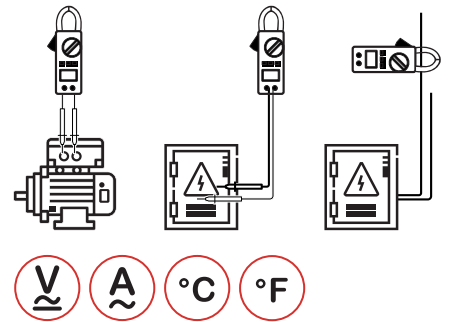
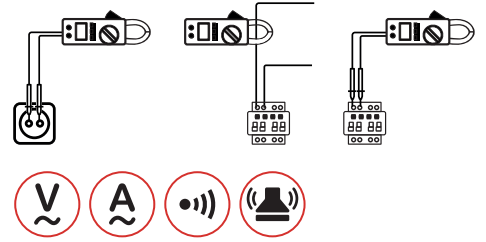

DIGITAL CLAMP TRANSDUCER
M266C

SKU NO.: M266CCBGLO
UPC CODE: 810053672471
EAN CODE: 8435394778112

FEATURE

- Data Hold.
- Low Battery Display.

SPECIFICATIONS

AC Voltage 750V	DC Voltage 1000V	AC Current 1000A
Resistance 2MΩ	Display Counts 2000	Continuity <100Ω
Jaw Opening 12mm/0.5"	Temperature 0°C~750°C/32°F~1382°F	

CONTENTS



235×96×46mm
9.25"×3.8"×1.8"
268g/0.59lb



1×9V 6F22
Battery



ACCESSORIES

Test Leads
K-type thermocouple
Carry bag
Battery



Calibration
Certificate



Quick Start
Guide

PACKAGING INFORMATION



Color Box
L130×W63×H255mm



Carton Box
53×34×28.5cm



X20PCS



MAIN APPLICATIONS

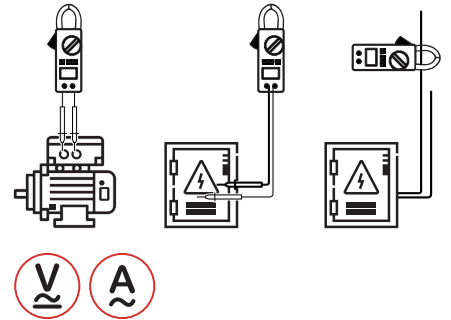
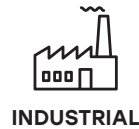
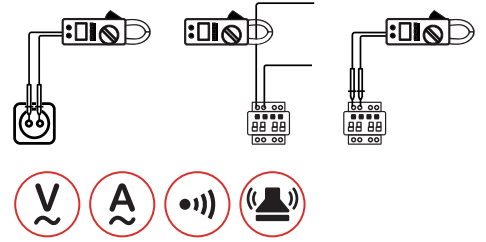

DIGITAL AC CLAMP METER
M266F

SKU NO.: M266FCBGLO
UPC CODE: 810053672488
EAN CODE: 8435394778129

FEATURE

- Diode open voltage 2.7V.
- Data Hold.
- Low Battery Display.

SPECIFICATIONS

AC Voltage 750V	DC Voltage 1000V	AC Current 1000A
Resistance 2MΩ	Frequency 2kHz	Display Counts 2000
Continuity <100Ω	Jaw Opening 12mm/0.5"	

CONTENTS



235×96×46mm
9.25"×3.8"×1.8"
268g/0.59lb



1×9V 6F22
Battery



ACCESSORIES

Test Leads
Carry bag
Battery



Calibration
Certificate



Quick Start
Guide

PACKAGING INFORMATION



Color Box
L130×W63×H255mm



Carton Box
53×34×28.5cm



X20PCS



MAIN APPLICATIONS

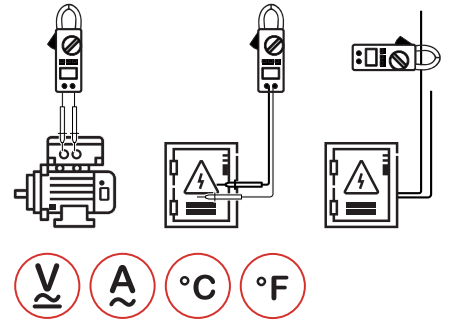
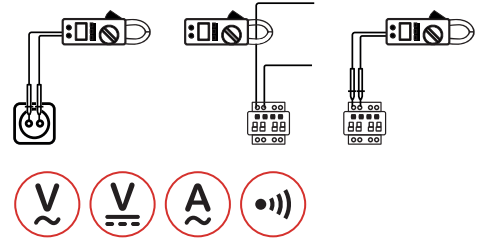

DIGITAL AC CLAMP METER
MS2000G

SKU NO.: MS2000GCBGLO
UPC CODE: 810053674093
EAN CODE: 8435394779164

FEATURE

- Diode Open Voltage 3.0V.
- Data Hold.
- Display Backlight.
- Low Battery Display.

SPECIFICATIONS

AC Voltage 750V	DC Voltage 1000V	AC Current 1000A
Resistance 2MΩ	Frequency 20kHz	Display Counts 2000
Jaw Opening 55mm/2.2"	Continuity <60Ω	
Temperature -0°C~750°C/32°F~1382°F		

CONTENTS



282×104×47mm
11"×4.1"×1.85"
570g/1.26lb



1×9V 6F22
Battery



ACCESSORIES

Test Leads
Wrapping Case
K type thermocouple
Battery



Calibration
Certificate



Quick Start
Guide

PACKAGING INFORMATION



Color Box
L300×W65×H250mm



Carton Box
61.5×37×27cm



X 10PCS



MAIN APPLICATIONS

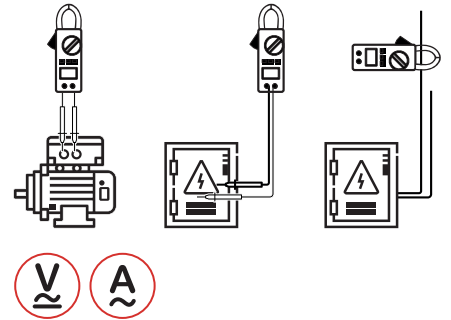
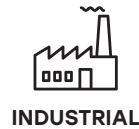
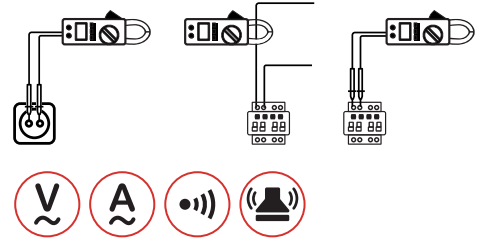

DIGITAL AC CLAMP METER
MS2001

SKU NO.: MS2001CBGLO
UPC CODE: 810053672341
EAN CODE: 8435394778044

FEATURE

- Diode Open Voltage 3.0V.
- Data Hold.
- Display Backlight.
- Low Battery Display.

SPECIFICATIONS

AC Voltage 750V	DC Voltage 1000V	AC Current 1000A
Resistance 2000Ω	Display Counts 2000	Jaw Opening 42mm/1.7"
Continuity <60Ω		

CONTENTS

- 250×99×43mm
9.8"×3.9"×1.7"
416g/0.92lb
- 1×9V 6F22 Battery
- Test Leads
Wrapping Case
Battery
- Calibration Certificate
- Quick Start Guide

PACKAGING INFORMATION

- Color Box**
L130×W60×H300mm
- Carton Box**
35.5×33×29cm
- X 10PCS**



MAIN APPLICATIONS

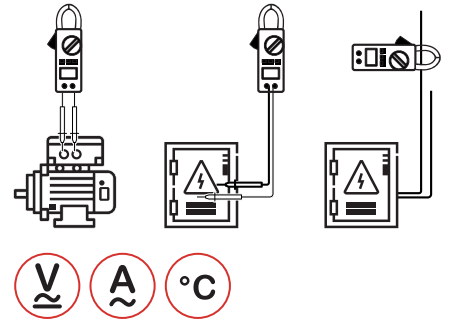
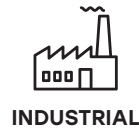
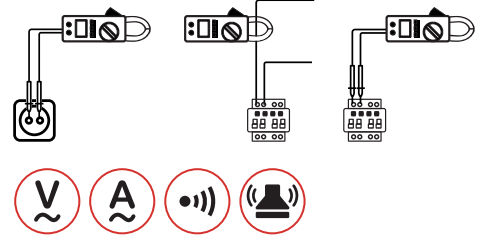

DIGITAL AC CLAMP METER
MS2001C

SKU NO.: MS2001CCBGLO
UPC CODE: 810053674109
EAN CODE: 8435394783055

FEATURE

- Data Hold.
- Display Backlight.
- Low Battery Display.

SPECIFICATIONS

AC Voltage 750V	DC Voltage 1000V	AC Current 1000A
Resistance 2000Ω	Display Counts 2000	Jaw Opening 42mm/1.7"
Continuity <60Ω	Temperature -40°C~750°C	

CONTENTS



250×99×43mm
9.8"×3.9"×1.7"
416g/0.92lb



1×9V 6F22
Battery



Test Leads
K-type thermocouple
Carry bag
Battery



Calibration
Certificate



Quick Start
Guide

PACKAGING INFORMATION



Color Box
L130×W60×H300mm



Carton Box
35.5×33×29cm



X 10PCS



MAIN APPLICATIONS

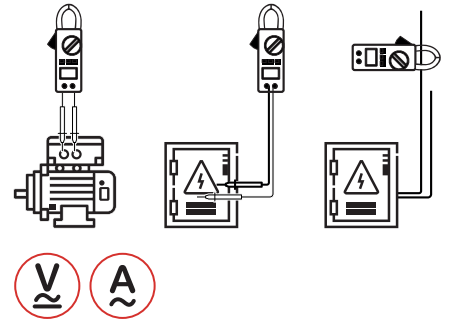
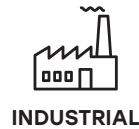
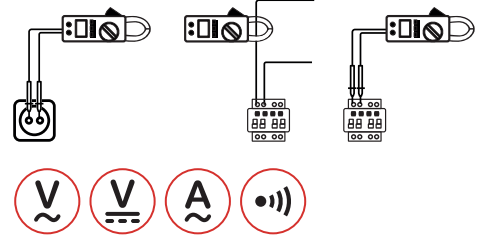

DIGITAL AC CLAMP METER
MS2001F

SKU NO.: MS2001FCBGLO
UPC CODE: 810053673218
EAN CODE: 84835394778945

FEATURE

- Data Hold.
- Diode and Continuity.

SPECIFICATIONS

AC Voltage 750V	DC Voltage 1000V	AC Current 1000A
Resistance 2000Ω	Display Counts 2000	Jaw Opening 42mm/1.7"

CONTENTS

- 250×99×43mm
9.8"×3.9"×1.7"
416g/0.92lb
- 1×9V 6F22 Battery
- Test Leads
Carry bag
Battery
- Calibration Certificate
- Quick Start Guide

PACKAGING INFORMATION

- Color Box**
L130×W60×H300mm
- Carton Box**
35.5×33×29cm
- X 10PCS**



MAIN APPLICATIONS

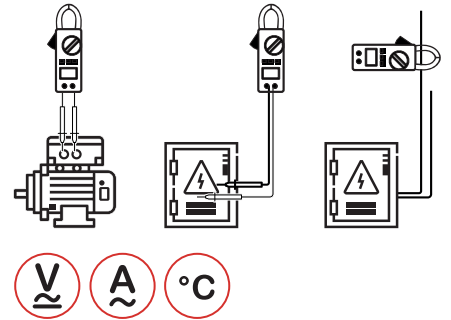
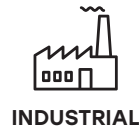
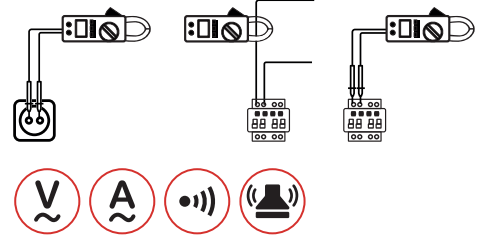

DIGITAL AC CLAMP METER
MS2008B

SKU NO.: MS2008BCBGLO
UPC CODE: 810053674123
EAN CODE: 8435394779195

FEATURE

- Auto & Manual Ranging.
- Auto Power Off.
- Display 4000 Counts.

SPECIFICATIONS

AC Voltage 600V	DC Voltage 600V	AC Current 600A
Resistance 40MΩ	Display Counts 4000	Jaw Opening 26mm/1.0"
Continuity <50Ω	Temperature -20°C~750°C	

CONTENTS



208×78×35mm
8.18"×3.1"×1.4"
240g/0.4lb



3×1.5V AAA
Batteries



Test Leads
K-type thermocouple
Carry bag
Battery



Calibration
Certificate



Quick Start
Guide

PACKAGING INFORMATION



Color Box
L105×W55×H235mm



Carton Box
50×30.5×23cm



X 20PCS



MAIN APPLICATIONS

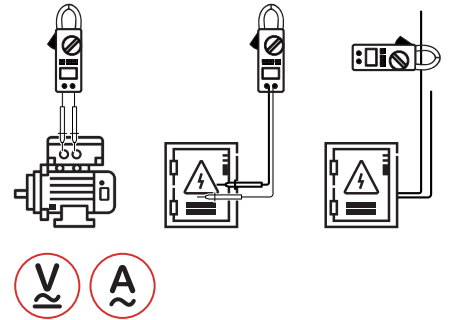
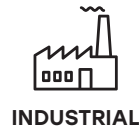
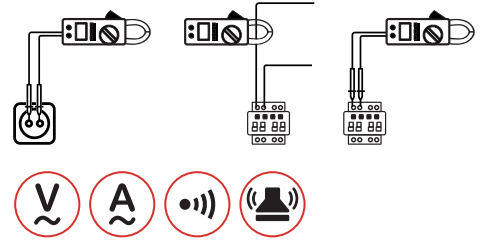

DIGITAL AC CLAMP METER
MS2009A

SKU NO.: MS2009ACBGLO
UPC CODE: 810053672549
EAN CODE: 8435394778181

FEATURE

- Auto & Manual Ranging.
- Auto Power Off.
- Non-Contact Voltage Detector.
- Diode Open Volatge 1.5V.

SPECIFICATIONS

AC Voltage 600V	DC Voltage 600V	AC Current 600A
Resistance 20MΩ	Display Counts 2000	Jaw Opening 26mm/1.0"
Continuity <60Ω		

CONTENTS

- 218×78×35mm
8.9"×3.1"×1.4"
239g/0.53lb
- 3×1.5V AAA Batteries
- Test Leads
Carry bag
Battery
- Calibration Certificate
- Quick Start Guide

PACKAGING INFORMATION

- Color Box**
L105×W55×H235mm
- Carton Box**
50×30.5×23cm
- X 20PCS**



MAIN APPLICATIONS

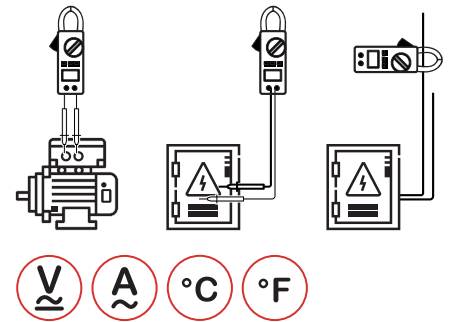
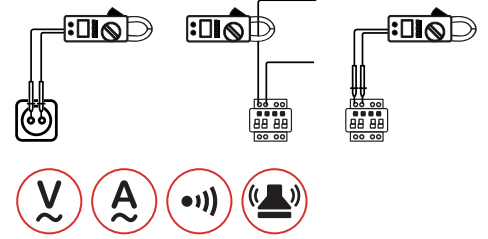

DIGITAL AC CLAMP METER
MS2009C

SKU NO.: MS2009CCBGLO
UPC CODE: 810053674130
EAN CODE: 8435394779201

FEATURE

- Auto & Manual Ranging.
- Auto Power Off.
- Non-Contact Voltage Detector.
- Diode Open Voltage 3.2V.

SPECIFICATIONS

AC Voltage 600V	DC Voltage 600V	AC Current 600A
Resistance 60MΩ	Capacitance 60mF	Frequency 1kHz
Display Counts 6000	Jaw Opening 26mm/1.0"	Continuity <50Ω
Temperature -20°C~1000°C/-4°F~1832°F		

CONTENTS



218×78×35mm
8.9"×3.1"×1.4"
239g/0.53lb



3×1.5V AAA
Batteries



Test Leads
K-type thermocouple
Carry bag
Battery



Calibration
Certificate



Quick Start
Guide

PACKAGING INFORMATION



Color Box
L105×W55×H235mm



Carton Box
50×30.5×23cm



X 20PCS



MAIN APPLICATIONS

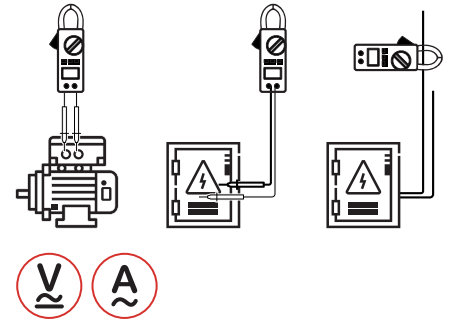
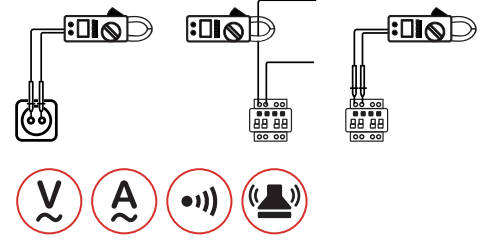

DIGITAL AC CLAMP METER
MS2025A

SKU NO.: MS2025ACBGLO
UPC CODE: 810053674147
EAN CODE: 8435394779218

FEATURE

- Auto & Manual Ranging.
- Auto Power Off.
- Non-Contact Voltage Detector.
- Relative Measurement.

SPECIFICATIONS

AC Voltage 750V	DC Voltage 1000V	AC Current 1000A
Resistance 60MΩ	Capacitance 100mF	Frequency 10kHz
Display Counts 6000	Jaw Opening 40mm/1.6"	Continuity <50Ω

CONTENTS



238×92×50mm
9.37"×3.6"×1.9"
390g/0.86lb



1×9V 6F22
Battery



ACCESSORIES

Test Leads
Carry bag
Battery



Calibration
Certificate



Quick Start
Guide

PACKAGING INFORMATION



Color Box
L130×W63×H255mm



Carton Box
53×34×28.5cm



X 20PCS



DIGITAL AC CLAMP METER **MS2025C**

SKU NO.: MS2025CCBGLO
UPC CODE: 810053674635
EAN CODE: 8435394779690

FEATURE

- Auto & Manual Ranging.
- Auto Power Off.
- Non-Contact Voltage Detector.
- Relative Measurement.

SPECIFICATIONS

AC Voltage 750V	DC Voltage 1000V	AC Current 1000A
Resistance 66MΩ	Capacitance 66mF	Continuity <50Ω
Frequency(A) 660Hz	Frequency(V) 6.6kHz	Display Counts 6600
Jaw Opening 40mm/1.6"	Temperature -20°C~1000°C/-4°F~1832°F	

MAIN APPLICATIONS

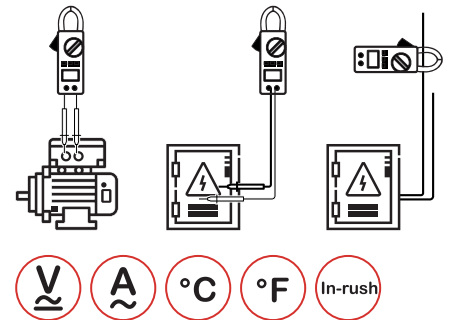
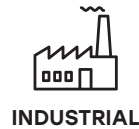
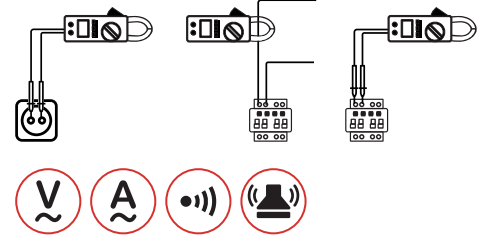

CONTENTS



238×92×50mm
9.37"×3.6"×1.9"
390g/0.86lb



1×9V 6F22
Battery



ACCESSORIES

Test Leads
K-type thermocouple
Carry bag
Battery



Calibration
Certificate



Quick Start
Guide

PACKAGING INFORMATION



Color Box
L130×W63×H255mm



Carton Box
53×34×28.5cm



X 20CS



MAIN APPLICATIONS

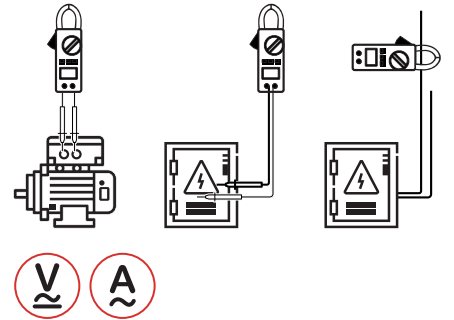
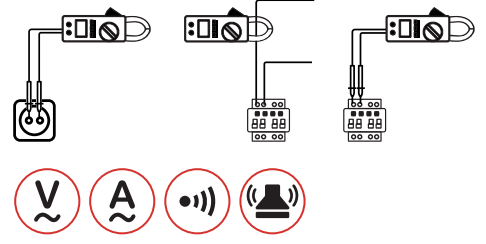

DIGITAL AC CLAMP METER
MS2026R

SKU NO.: MS2026RCBGLO
UPC CODE: 810053676776
EAN CODE: 8435394785301

FEATURE

- Auto & Manual Ranging.
- Auto Power Off.
- Diode Open Voltage 3.3V.
- Low Battery Display.

SPECIFICATIONS

AC Voltage 750V	DC Voltage 1000V	DC Current 1000A
Resistance 60MΩ	Capacitance 4000μF	Frequency 10kHz
Display Counts 6000	Jaw Opening 40mm/1.6"	Continuity <50±20Ω

CONTENTS

- 222x86x32mm
8.74"x3.38"x1.26"
323g/0.71lb
- 3x1.5V AAA Batteries
- Test Leads
- Carry bag
- Battery
- Calibration Certificate
- Quick Start Guide

PACKAGING INFORMATION

- Color Box**
L130xW63xH255mm
- Carton Box**
53x34x28.5cm
- X 20PCS**



DIGITAL AC CLAMP METER **MS2028A**

SKU NO.: MS2028ACBGLO
UPC CODE: 810053674642
EAN CODE: 8435394779706

FEATURE

- Auto & Manual Ranging.
- Auto Power Off.
- Diode Open Voltage 1.5V.
- True Root Mean Square.

SPECIFICATIONS

AC Voltage 600V	DC Voltage 600V	DC Current 600A
Resistance 20MΩ	Display Counts 2000	Jaw Opening 26mm/1.0"
Continuity <50Ω		

MAIN APPLICATIONS

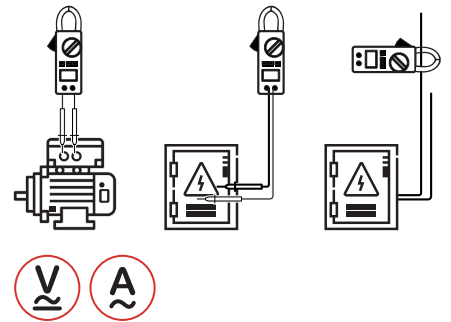
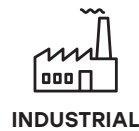
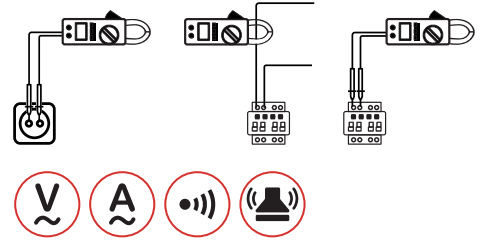

CONTENTS



208×78×35mm
8.2"×3.1"×1.4"
245g/0.54lb



3×1.5V AAA
Batteries



Test Leads
Carry bag
Battery



Calibration
Certificate



Quick Start
Guide

PACKAGING INFORMATION



Color Box
L105×W55×H235mm



Carton Box
50×30.5×23cm



X 20PCS



MAIN APPLICATIONS

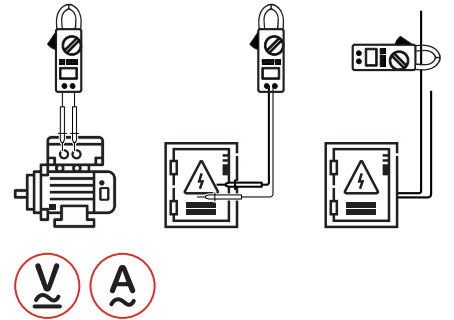
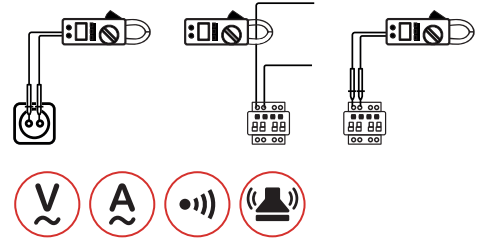

DIGITAL AC CLAMP METER
MS2030

SKU NO.: MS2030CBGLO
UPC CODE: 810053672556
EAN CODE: 8435394778198





FEATURE

- Diode Open Voltage 4.5V.
- Data Hold.
- Low Battery Display.



SPECIFICATIONS

AC Voltage 600V	DC Voltage 600V	AC Current 400A
Resistance 2kΩ	Display Counts 2000	Jaw Opening 28mm/1.1"
Continuity <50±20Ω		

CONTENTS

	198×79×38mm 7.8"×3.1"×1.5" 195g/0.43lb		3×1.5V AAA Batteries
	Test Leads Carry bag Battery		Calibration Certificate
			Quick Start Guide

PACKAGING INFORMATION

	Color Box L105×W55×H235mm	
	Carton Box 50×30.5×23cm	 X 20PCS



MAIN APPLICATIONS

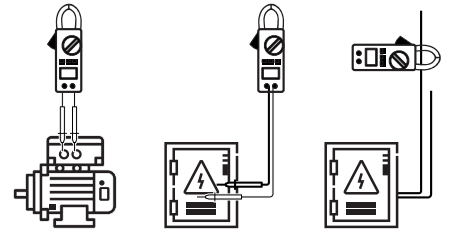
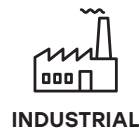
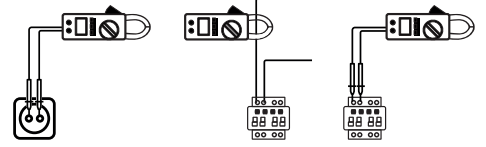

DIGITAL AC CLAMP METER
MS2030B

SKU NO.: MS2030BCBGLO
UPC CODE: 810053674666
EAN CODE: 8435394779720

FEATURE

- Auto & Manual Ranging.
- Auto Power Off.
- Data Hold.
- Non-Contact Voltage Detector.

SPECIFICATIONS

AC Voltage 600V	DC Voltage 600V	AC Current 600A
Resistance 40MΩ	Capacitance 100μF	Frequency 10kHz
Display Counts 4000	Jaw Opening 28mm/1.1"	Continuity <50±20Ω
Temperature -20°C~1000°C/-4°F~1832°F		

CONTENTS



198×79×38mm
7.8"×3.1"×1.5"
195g/0.43lb



3×1.5V AAA
Batteries



ACCESSORIES

Test Leads
K-type thermocouple
Carry bag
Battery



Calibration
Certificate



Quick Start
Guide

PACKAGING INFORMATION



Color Box
L105×W55×H235mm



Carton Box
50×30.5×23cm



X 20PCS



MAIN APPLICATIONS

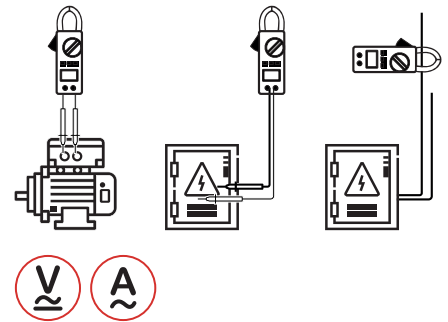
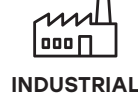
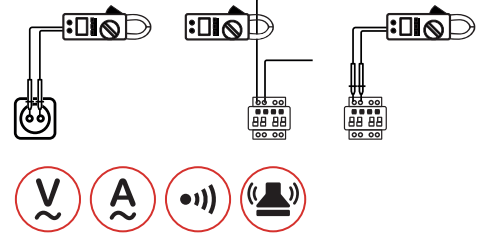

SMART DIGITAL CLAMP METER
MS2033A

SKU NO.: MS2033ACBGLO
UPC CODE: 810053674932
EAN CODE: 8435394782676

FEATURE

- Auto Ranging.
- Auto Power Off.
- Dual Display.
- MAX/MIN.

SPECIFICATIONS

AC Voltage 600V	DC Voltage 600V	AC Current 600A
Resistance 10MΩ	Frequency 3kHz	Display Counts 6000
Jaw Opening 26mm/1.0"	Continuity <40Ω	

CONTENTS



204x78x43mm
8"x3.07"x1.77"
195g/0.43lb



3x1.5V AAA
Batteries



ACCESSORIES

Test Leads
Carry bag
Battery



Calibration
Certificate



Quick Start
Guide

PACKAGING INFORMATION



Color Box
L105xW55xH235mm



Carton Box
50x30.5x23cm



X 20PCS



MAIN APPLICATIONS

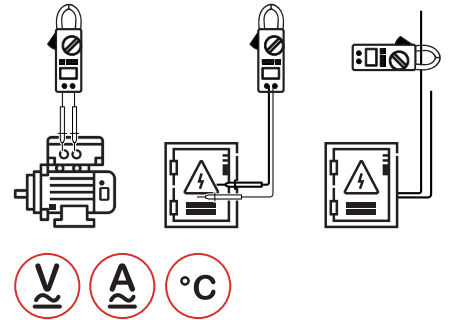
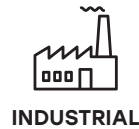
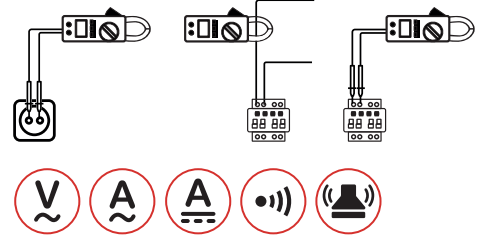

DIGITAL AC/DC CLAMP METER
MS2101

SKU NO.: MS2101CBGLO
UPC CODE: 810053672105
EAN CODE: 8435394777832

FEATURE

- Auto and Manual Ranging.
- Auto Power Off.
- Diode Open Voltage 2.2V.
- Data Hold.

SPECIFICATIONS

AC Voltage 750V	DC Voltage 1000V	AC Current 1000A
DC Current 1000A	Resistance 40MΩ	Capacitance 100μF
Frequency 100kHz	Display Counts 4000	Jaw Opening 42mm/1.7"
Continuity <50Ω±20Ω	Temperature -40°C~750°C	

CONTENTS



250×99×43mm
9.8"×3.9"×1.7"
416g/0.92lb



1×9V 6F22
Battery



ACCESSORIES

Test Leads
K-type thermocouple
Carry bag
Battery



Calibration
Certificate



Quick Start
Guide

PACKAGING INFORMATION



Color Box
L130×W60×H300mm



Carton Box
35.5×33×29cm



X 10PCS



MAIN APPLICATIONS

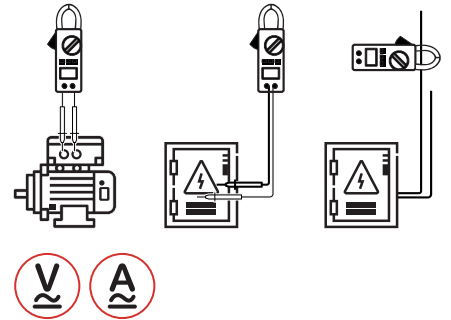
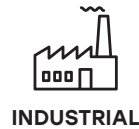
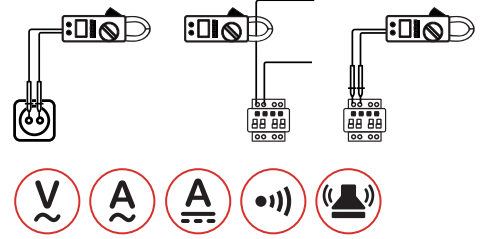

DIGITAL AC/DC CLAMP METER
MS2108

SKU NO.: MS2108CBGLO
UPC CODE: 810053673232
EAN CODE: 8435394778969

FEATURE

- Auto & Manual Ranging.
- Auto Power Off.
- Inrush 100ms Current Integral.
- True Root Mean Square.

SPECIFICATIONS

AC Voltage 600V	DC Voltage 600V	AC Current 600A
DC Current 600A	Resistance 66MΩ	Capacitance 66mF
Frequency 1kHz	Display Counts 6600	

CONTENTS



208x78x53mm
8.2"x3.1"x1.4"
245g/0.54lb



3x1.5V AAA
Batteries



ACCESSORIES

Test Leads
Carry bag
Battery



Calibration
Certificate



Quick Start
Guide

PACKAGING INFORMATION



Color Box
L105xW55xH235mm



Carton Box
50x30.5x23cm



X 20PCS



MAIN APPLICATIONS

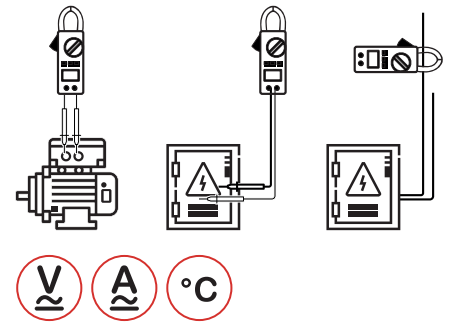
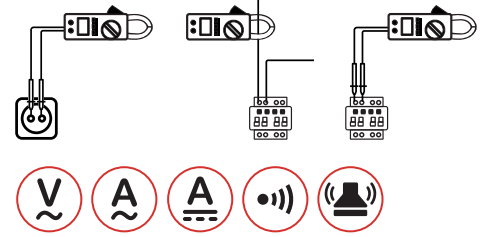

DIGITAL AC/DC CLAMP METER
MS2109A

SKU NO.: MS2109ACBGLO
UPC CODE: 810053672112
EAN CODE: 8435394777849

FEATURE

- Auto Ranging.
- Auto Power Off.
- Non-Contact Voltage Detector.
- Relative Measurement.

SPECIFICATIONS

AC Voltage 600V	DC Voltage 600V	AC Current 600A
DC Current 600A	Resistance 60MΩ	Capacitance 4000μF
Frequency 10kHz	Display Counts 6000	Jaw Opening 26mm/1.0"
Temperature -20°C~1000°C/-4°F~1832°F		Continuity <50±20Ω

CONTENTS



218×78×35mm
8.9"×3.1"×1.4"
239g/0.53lb



3×1.5V AAA
Batteries



ACCESSORIES

Test Leads
K-type thermocouple
Carry bag
Battery



Calibration
Certificate



Quick Start
Guide

PACKAGING INFORMATION



Color Box
L105xW55xH235mm



Carton Box
50×30.5×23cm



X 20PCS



MAIN APPLICATIONS

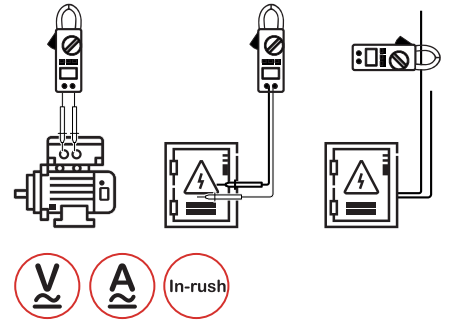
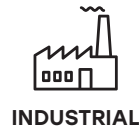
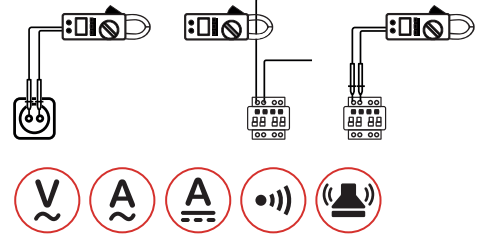

DIGITAL AC/DC CLAMP METER
MS2125A

SKU NO.: MS2125ACBGLO
UPC CODE: 810053672129
EAN CODE: 8435394777856

FEATURE

- Auto & Manual Ranging.
- Auto Power Off.
- Non-Contact Voltage Detector.
- Relative Measurement.

SPECIFICATIONS

AC Voltage 750V	DC Voltage 1000V	AC Current 1000A
DC Current 1000A	Resistance 60MΩ	Capacitance 100mF
Frequency 1000Hz	Display Counts 6000	Jaw Opening 40mm/1.6"
Continuity <50Ω		

CONTENTS

- 238×92×50mm
9.37"×3.6"×1.9"
386g/0.85lb
- 1×9V 6F22 Battery
- Test Leads
Carry bag
Battery
- Calibration Certificate
- Quick Start Guide

PACKAGING INFORMATION

- Color Box**
L130×W63×H255mm
- Carton Box**
53×34×28.5mm
- X 20PCS**



DIGITAL AC/DC CLAMP METER
MS2128

SKU NO.: MS2128CBGLO
UPC CODE: 810053674178
EAN CODE: 8435394779249

FEATURE

- Auto & Manual Ranging.
- Auto Power Off.
- Inrush 100ms Current Integral.
- True Root Mean Square.

SPECIFICATIONS

AC Voltage 600V	DC Voltage 600V	AC Current 600A
DC Current 600A	Resistance 66MΩ	Capacitance 66mF
Frequency(A) 1kHz	Frequency(V) 10kHz	Display Counts 6600
Jaw Opening 26mm/1.0"	Continuity <50±20Ω	

MAIN APPLICATIONS

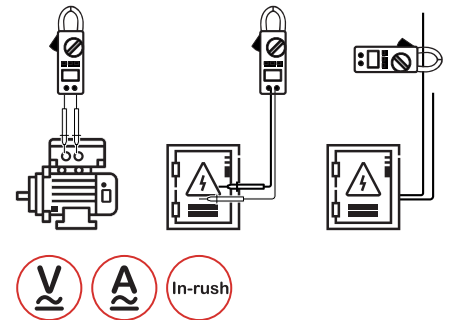
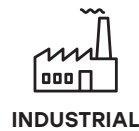
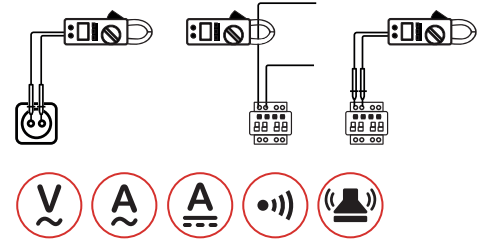

CONTENTS



208x78x53mm
8.2"x3.1"x1.4"
245g/0.54lb



3x1.5V AAA
Batteries



Test Leads
Carry bag
Battery



Calibration
Certificate



Quick Start
Guide

PACKAGING INFORMATION



Color Box
L105xW55xH235mm



Carton Box
50x30.5x23cm



X 20PCS



MAIN APPLICATIONS



DOMESTIC

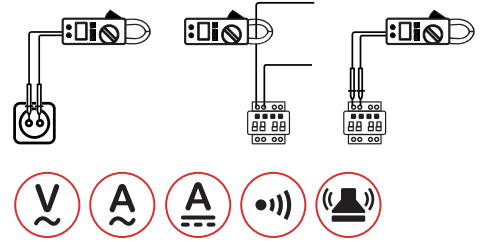

INDUSTRIAL

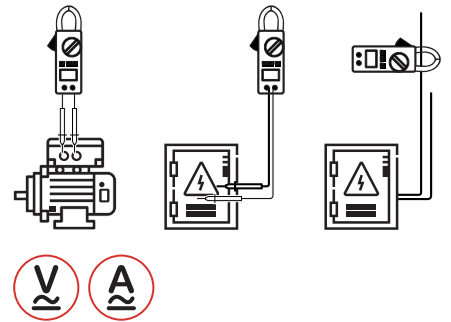

DIGITAL AC/DC CLAMP METER
MS2128A

SKU NO.: MS2128ACBGLO
UPC CODE: 810053674673
EAN CODE: 8435394779737

FEATURE

- Auto & Manual Ranging.
- Auto Power Off.
- Relative measurement.
- Diode Open Voltage 3.0V.

SPECIFICATIONS

AC Voltage 600V	DC Voltage 600V	AC Current 400A
DC Current 400A	Resistance 40MΩ	Capacitance 4000μF
Frequency(A) 1kHz	Frequency(V) 10kHz	Frequency(Hz) 10kHz
Display Counts 4000	Jaw Opening 26mm/1.0"	Continuity <50±20Ω

CONTENTS



208×78×53mm
8.2"×3.1"×1.4"
245g/0.54lb



3×1.5V AAA
Batteries



ACCESSORIES

Test Leads
Carry bag
Battery



Calibration
Certificate



Quick Start
Guide

PACKAGING INFORMATION



Color Box
L105×W55×H235mm



Carton Box
50×30.5×23cm



X 20PCS



DIGITAL AC/DC CLAMP METER
MS2138

SKU NO.: MS2138CBGLO
UPC CODE: 810053672136
EAN CODE: 8435394778464

FEATURE

- Auto & Manual Ranging.
- Auto Power Off.
- Diode Open Voltage 2.8V.
- Relative Measurement.

SPECIFICATIONS

AC Voltage 600V	DC Voltage 600V	AC Current 1000A
DC Current 1000A	Resistance 40MΩ	Capacitance 4000μF
Frequency 10kHz	Display Counts 4000	Jaw Opening 40mm/1.6"
Continuity <50±20Ω		

MAIN APPLICATIONS

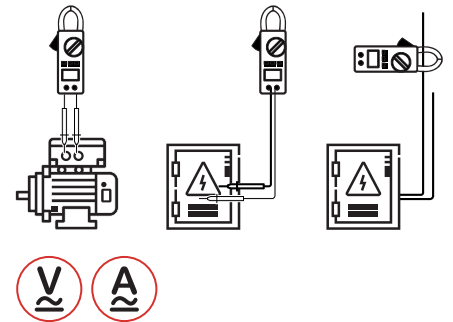
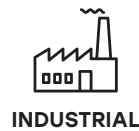
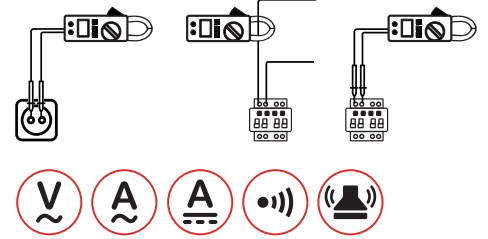

CONTENTS



222×86×32mm
8.74"×3.38"×1.26"
323g/0.71lb



3×1.5V AAA
Batteries



Test Leads
Carry bag
Battery



Calibration
Certificate



Quick Start
Guide

PACKAGING INFORMATION



Color Box
L130×W63×H255mm



Carton Box
53×34×28.5mm



X 20PCS



DIGITAL AC/DC CLAMP METER (T-RMS)
MS2138R

SKU NO.: MS2138RCBGLO
UPC CODE: 810053672143
EAN CODE: 8435394777863

FEATURE

- Auto & Manual Ranging.
- Auto Power Off.
- Diode Open Voltage 2.8V.
- Relative Measurement.

SPECIFICATIONS

AC Voltage 600V	DC Voltage 600V	AC Current 1000A
DC Current 1000A	Resistance 40MΩ	Capacitance 4000μF
Frequency 10kHz	Continuity test <50±20Ω	Display Counts 4000
Jaw Opening 40mm/1.6"		

MAIN APPLICATIONS

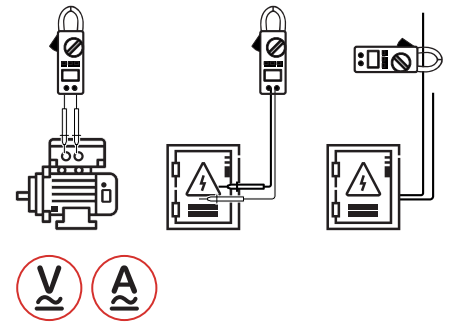
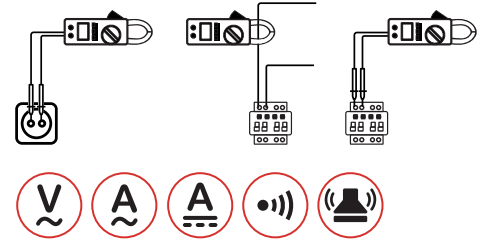

CONTENTS



222×86×32mm
8.74"×3.38"×1.26"
323g/0.71lb



3×1.5V AAA
Batteries



Test Leads
Carry bag
Battery



Calibration
Certificate



Quick Start
Guide

PACKAGING INFORMATION



Color Box
L130×W63×H255mm



Carton Box
53×34×28.5mm



X 20PCS



MAIN APPLICATIONS

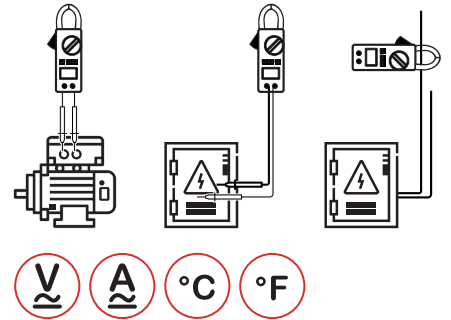
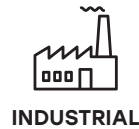
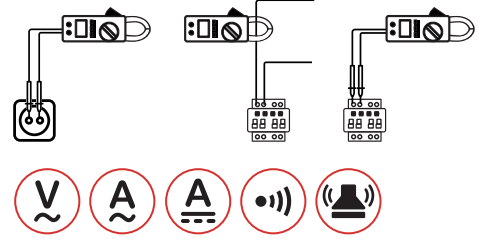

DIGITAL AC/DC CLAMP METER
MS2160

SKU NO.: MS2160CBGLO
UPC CODE: 810053674185
EAN CODE: 8435394779256

FEATURE

- Auto & Manual Ranging.
- Auto Power Off.
- Non-Contact Voltage Detector.
- Diode Open Voltage 3.2V.

SPECIFICATIONS

AC Voltage 600V	DC Voltage 600V	AC Current 80A
DC Current 80A	Resistance 40MΩ	Capacitance 40mF
Frequency 10kHz	Display Counts 4000	Continuity <50Ω
Jaw Opening 24mm/0.9"	Temperature -20°C~100°C/-4°F~1832°F	

CONTENTS



195×80×45mm
7.8"×3.1"×1.8"
195g/0.43lb



3×1.5V AAA
Batteries



Test Leads
K-type thermocouple
Carry bag
Battery



Calibration
Certificate



Quick Start
Guide

PACKAGING INFORMATION



Color Box
L105×W55×H235mm



Carton Box
50×30.5×23cm



X 20PCS



MAIN APPLICATIONS



INDUSTRIAL

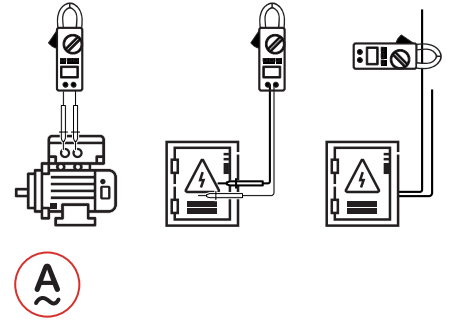

**HIGH SENSITIVITY
AC LEAKAGE CLAMP METER
MS2006B**

SKU NO.: MS2006BCBGLO
UPC CODE: 810053672532
EAN CODE: 8435394778174

FEATURE

- Auto Power Off.
- Data Hold.
- Low Battery Display.

SPECIFICATIONS

AC Current 60A	Display Counts 2000	Jaw Opening 31mm/1.2"
--------------------------	-------------------------------	---------------------------------

CONTENTS



176×59×28mm
6.9"×2.3"×1.1"
150g/0.33lb



2×1.5V AAA
Batteries



Carry bag
Battery

ACCESSORIES



Calibration
Certificate



Quick Start
Guide

PACKAGING INFORMATION



Color Box
L75×W45×H190mm



Carton Box
45×33×29.5cm



X 50PCS



MAIN APPLICATIONS

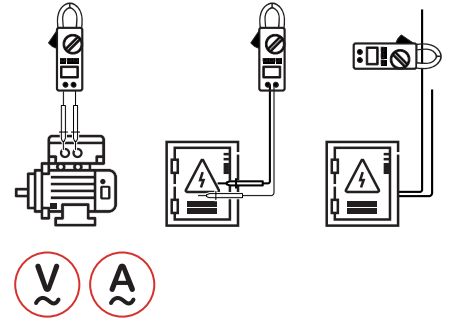
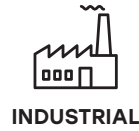

THREE PHASE DIGITAL POWER CLAMP METER

MS2203

SKU NO.: MS2203CBGLO
 UPC CODE: 810053672570
 EAN CODE: 8435394778211

FEATURE

- Auto & Manual Ranging.
- Data Logging 28 groups.
- True Root Mean Square.
- Bar Graph.

SPECIFICATIONS

AC Voltage 600V	AC Current 1000A	Frequency 1000Hz
Active Power 600kW	Apparent Power 600kVA	Reactive Power 600kVAr
Jaw Opening 50mm/2.0"	Display Counts 9999	

CONTENTS



300x103x51mm
 11.8"x4.1"x2.0"
 640g/1.4lb



4x1.5V AAA
 Batteries



ACCESSORIES

Test Leads
 Alligator clip
 RS232C interface cable
 PC data record graph
 software
 Carry Case
 Battery



Calibration
 Certificate



Quick Start
 Guide

PACKAGING INFORMATION



Color Box
 L370xW140xH324mm



Carton Box
 58x39x35cm



X 4PCS



THREE PHASE DIGITAL POWER CLAMP METER
MS2205

SKU NO.: MS2205CBAGLO
UPC CODE: 810053674192
EAN CODE: 8435394779263

FEATURE

- Auto & Manual Ranging.
- Auto Power Off.
- Data Hold.
- True Root Mean Square.

SPECIFICATIONS

AC Voltage 600V	AC Current 1000A	Frequency 1000Hz
Active Power 600kW	Apparent Power 600kVA	Reactive Power 600kVAR
Jaw Opening 50mm/2.0"	Display Counts 6000	

MAIN APPLICATIONS

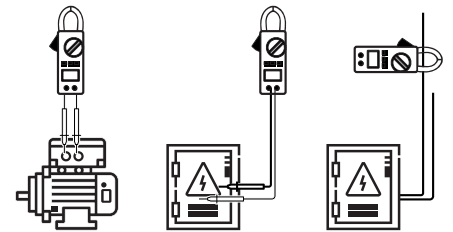
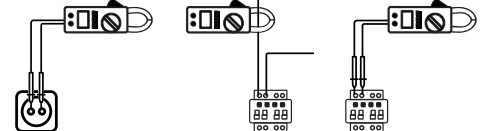

CONTENTS



300x103x51mm
11.8"x4.1"x2.0"
640g/1.4lb



4x1.5V AAA
Batteries



ACCESSORIES

Test Leads
Alligator clip
RS232C interface cable
PC data record graph
software
Carry Case
Battery



Calibration
Certificate



Quick Start
Guide

PACKAGING INFORMATION



Color Box
L370xW140xH324mm



Carton Box
58x39x35cm



X 4PCS



SINGLE PHASE POWER CLAMP METER
MS2225A

SKU NO.: MS2225ACBGLO
UPC CODE: 810053674680
EAN CODE: 8435394779744

FEATURE

- Auto & Manual Ranging.
- Auto Power Off.
- True Root Mean Square.
- Diode Open voltage 3.2V.

SPECIFICATIONS

AC Voltage 750V	DC Voltage 1000V	AC Current 1000A
Resistance 60MΩ	Capacitance 1000mF	Continuity <50Ω
Frequency 10kHz	Display Counts 6000	Jaw Opening 40mm/1.6"

MAIN APPLICATIONS

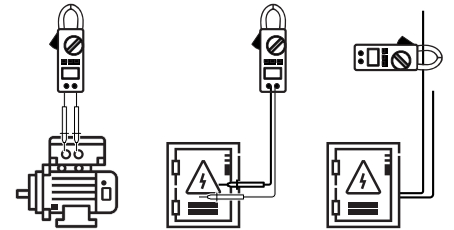
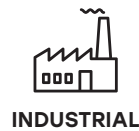
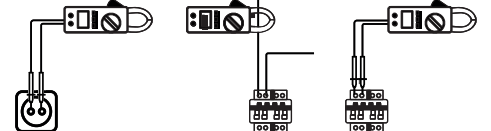

CONTENTS



250×98×53mm
9.84"×3.78"×2.09"
450g/0.99lb



1×9V 6F22
Battery



ACCESSORIES

Test Leads
Carry bag
Battery



Calibration
Certificate

Alligator clip
(option)



Quick Start
Guide

PACKAGING INFORMATION



Color Box
L130×W63×H255mm



Carton Box
53×34×28.5mm



X 20PCS



MAIN APPLICATIONS

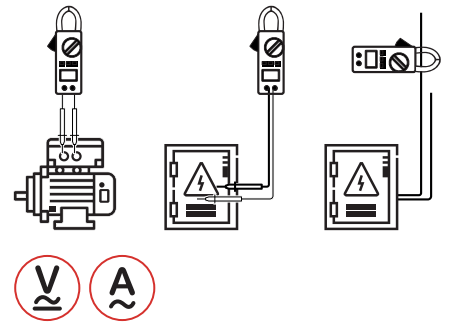
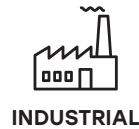
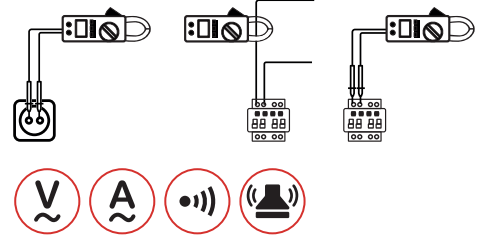

AC/DC CLAMP METER
M9912

SKU NO.: M9912CBAGLO
UPC CODE: 810053674079
EAN CODE: 8435394779140

FEATURE

- Diode and Continuity.
- Display Backlight.
- Data Hold.

SPECIFICATIONS

AC Voltage 750V	DC Voltage 750V	AC Current 1000A
DC Current 1000A	Resistance 30MΩ	Frequency 30kHz
Display Counts 3200	Jaw Opening 55mm/2.2"	

CONTENTS



282x104x47mm
11.1"x4.09"x1.85"
500g/0.83lb



1x9V 6F22
Battery



ACCESSORIES

Test Leads
Carry bag
Battery



Calibration
Certificate



Quick Start
Guide

PACKAGING INFORMATION



Color Box
L300xW65xH250mm



Carton Box
61.5x37x27cm



X 10PCS



MAIN APPLICATIONS

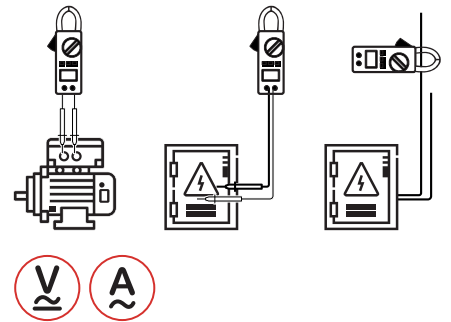
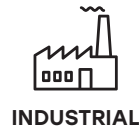
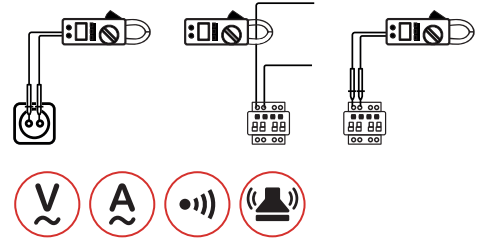

DIGITAL CLAMP METER
MS2015A

SKU NO.: MS2015ACBGLO
UPC CODE: 810053673256
EAN CODE: 8435394778983

FEATURE

- Display 6000 Counts.
- Auto & Manual Ranging.
- Non-Contact Voltage Detector.

SPECIFICATIONS

AC Voltage 750V	DC Voltage 1000V	AC Current 1000A
Resistance 60MΩ	Capacitance 100mF	Frequency(A) 10MHz
Display Counts 6000	Jaw Opening 40mm/1.6"	

CONTENTS



82×42×32mm
3.2"×1.65"×1.26"
45g/0.1lb



1×9V 6F22
Battery



ACCESSORIES

Test Leads
Carry bag
Battery



Calibration
Certificate



Quick Start
Guide

PACKAGING INFORMATION



Color Box
L130×W63×H255mm



Carton Box
53×34×28.5mm



X 20PCS



MAIN APPLICATIONS

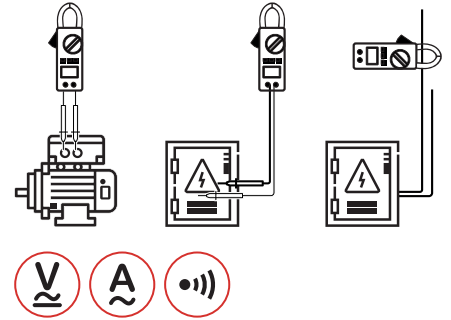

CONTENTS



192×68×43mm
7.56"×2.67"×1.7"
230g/0.5lb



1×9V 6F22
Battery



ACCESSORIES

Test Leads
Carry bag
Battery



Calibration
Certificate



Quick Start
Guide

DIGITAL AC CLAMP METER
MS2600

SKU NO.: MS2600CBGLO
UPC CODE: 810053676806
EAN CODE: 8435394785332

FEATURE

- Auto & Manual Ranging.
- Auto Power Off.
- Relative Measurement.
- Diode Open Voltage 1.5V.

SPECIFICATIONS

AC Voltage 700V	DC Voltage 1000V	AC Current 200A
Resistance 40MΩ	Capacitance 40μF	Frequency(Hz/Duty) 4kHz/100kHz
Display Counts 4000	Jaw Opening 12mm/0.5"	Continuity <50±20Ω

PACKAGING INFORMATION



Color Box
L172×W80×H255mm



Carton Box
53×44.5×37cm



X 20PCS



MAIN APPLICATIONS

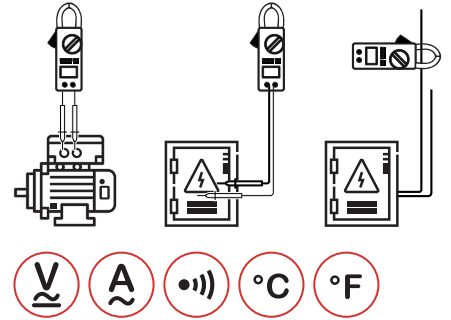

CONTENTS



201×65×43mm
7.7"×2.6"×1.7"
265g/0.58lb



1×9V 6F22
Battery



ACCESSORIES

Test Leads
K type thermocouple
Carry bag
Battery



Calibration
Certificate



Quick Start
Guide

DIGITAL AC CLAMP METER
MS2601

SKU NO.: MS2601CBGLO
UPC CODE: 810053674215
EAN CODE: 8435394779287

FEATURE

- Auto & Manual Ranging.
- Auto Power Off.
- Non-Contact Voltage Detector.
- Diode Open Voltage 3.2V.

SPECIFICATIONS

AC Voltage 600V	DC Voltage 600V	AC Current 200A
Resistance 60MΩ	Capacitance 60mF	Frequency(A/V) 60Hz/60MHz
Display counts 6000	Jaw opening 12mm/0.5"	Continuity <50Ω
Temperature -20°C~400°C/-4°F~752°F		

PACKAGING INFORMATION



Color Box
L172×W80×H255mm



Carton Box
53×44.5×37cm



X 20PCS



MAIN APPLICATIONS

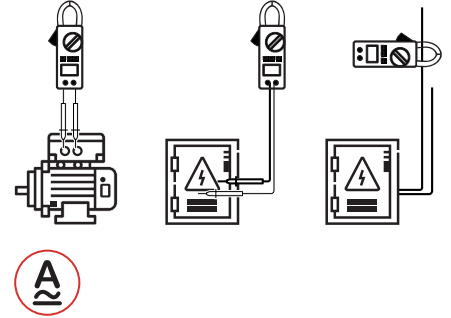

DIGITAL CLAMP TRANSDUCER
MS3300

SKU NO.: MS3300CBGLO
UPC CODE: 810053675090
EAN CODE: 8435394783086

FEATURE

- True Root Mean Square.
- DCA Zero Adjust.

SPECIFICATIONS

AC Current 1000A	DC Current 1000A	AC Output 1mV/A
DC Output 1mV/A	Jaw opening 55mm/2.2"	

CONTENTS



256×104×47mm
9.3"×3.86"×1.9"
520g/1.1lb



1×9V 6F22
Battery



ACCESSORIES

Wrapping Case



Calibration
Certificate



Quick Start
Guide

PACKAGING INFORMATION



Color Box
L300×W65×H250mm



Carton Box
61.5×37×27cm



X 10PCS



DIGITAL CLAMP TRANSDUCER
MS3302

SKU NO.: MS3302CBGLO
UPC CODE: 810053674697
EAN CODE: 8435394784311

FEATURE

- Jaw Opening Φ 28mm/1.1".

SPECIFICATIONS

AC Current
400A

Output
1mV/A

MAIN APPLICATIONS



INDUSTRIAL

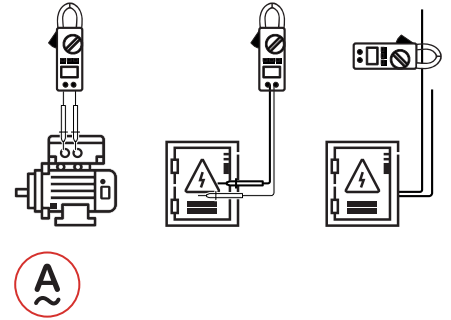

CONTENTS



143×64×30mm
5.6"×2.5"×1.2"
185g/0.4lb



Calibration Certificate



ACCESSORIES

Wrapping Case



Quick Start Guide

PACKAGING INFORMATION



Color Box
L115×W55×H165mm



Carton Box
47.5×34.5×32cm



X 40PCS

AC LINE SPLITTERS

USA TYPE | EU TYPE | UK TYPE





AC LINE SPLITTER

MS922A

SKU NO.: MS922ACBGLO
 UPC CODE: 810053675380
 EAN CODE: 8435394783420

FEATURE

- Allows for Easy AC Current Measurements Using a Clamp Meter on 2 or 3 Wire Power Cords.
- Voltage Check Sockets for Easy Power Calculations.

SPECIFICATIONS

AC Voltage 125V	AC Current 15A
---------------------------	--------------------------

MAIN APPLICATIONS

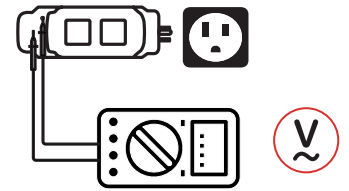
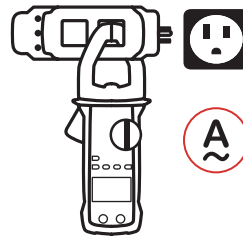

CONTENTS



171x57x48mm
 6.7"x2.2"x1.9"
 131g/0.29lb



Calibration Certificate



Quick Start Guide

PACKAGING INFORMATION



Color Box
 L85xW65xH230mm



Carton Box
 48x34.5x36.5cm



X 40PCS



MAIN APPLICATIONS

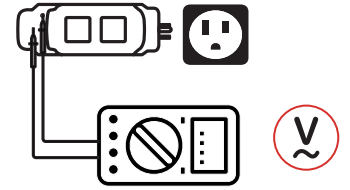
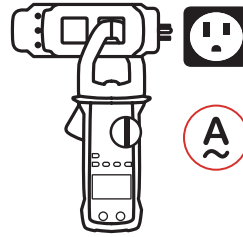

CONTENTS



200x57x48mm
7.8"x2.2"x2.9"
140g/0.3lb



Calibration Certificate



Quick Start Guide

PACKAGING INFORMATION



Color Box
L85xW65xH230mm



Carton Box
48x34.5x36.5cm



X 40PCS

AC LINE SPLITTER

MS922D

SKU NO.: MS922DCBGLO
UPC CODE: 810053675397
EAN CODE: 8435394783437

FEATURE

- Allows for Easy AC Current Measurements Using a Clamp Meter on 2 or 3 Wire Power Cords.
- Voltage Check Sockets for Easy Power Calculations.

SPECIFICATIONS

AC Voltage
250V

AC Current
15A



AC LINE SPLITTER
MS922E

SKU NO.: MS922ECBGLO
UPC CODE: 810053675403
EAN CODE: 8435394783444

FEATURE

- Allows for Easy AC Current Measurements Using a Clamp Meter on 2 or 3 Wire Power Cords.
- Voltage Check Sockets for Easy Power Calculations.

SPECIFICATIONS

AC Voltage 250V	AC Current 15A
---------------------------	--------------------------

MAIN APPLICATIONS

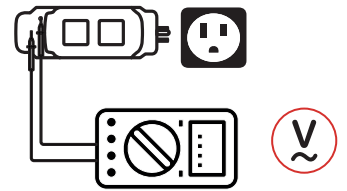
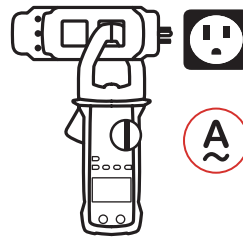

CONTENTS



173x57x48mm
6.8"x2.2"x1.9"
131g/0.29lb



Calibration Certificate



Quick Start Guide

PACKAGING INFORMATION



Color Box
L85xW65xH230mm



Carton Box
48x34.5x36.5cm



X 40PCS

ELECTRICAL TESTERS

NON CONTACT VOLTAGE TESTER
TWO POLE VOLTAGE TESTER





NCV WITH INFRARED THERMOMETER MS6580B

SKU NO.: MS6580BCBGLO
UPC CODE: 810053675250
EAN CODE: 8435394783260

FEATURE

- Non-Contact Voltage Detector.
- NCV Sensitivity 4 Levels.
- Infrared Temperature.
- Spectral Response 8-14 μm .

SPECIFICATIONS

AC Voltage
1000V

Temperature
-20°C~330°C/-46°F~626°F

Repeatability
 $\pm 0.1^\circ\text{C}$

Emissivity
0.95

MAIN APPLICATIONS

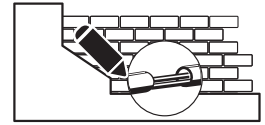

CONTENTS



152×31×31mm
6"×1.22"×1.22"
220g/0.44lb



2×1.5V AAA
Batteries



ACCESSORIES

Battery



Calibration
Certificate



Quick Start
Guide

PACKAGING INFORMATION



Color Box
L82×W40×H184mm



Carton Box
39×22×35.5cm



X 40PCS



MAIN APPLICATIONS

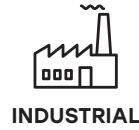
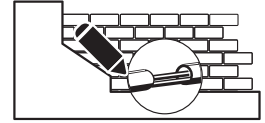

NON CONTACT AC VOLTAGE DETECTOR
MS8900

SKU NO.: MS8900CBGLO
UPC CODE: 810053672723
EAN CODE: 8435394778365

FEATURE

- Sound and Light Instruction.
- Double Molded Case.
- Operating Temperature 0°C~50°C.

SPECIFICATIONS

AC Voltage 100~240V	Frequency 50Hz~60Hz	Humidity 85%RH
-------------------------------	-------------------------------	--------------------------

CONTENTS



157×24×20mm
6.18"×0.94"×0.78"
42g/0.09lb



2×1.5V AAA
Batteries



ACCESSORIES

Battery



Calibration
Certificate



Quick Start
Guide

PACKAGING INFORMATION



Color Box
L82×W40×H184mm



Carton Box
39×22×35.5cm



X 40PCS



NON CONTACT AC VOLTAGE DETECTOR MS8900A

SKU NO.: MS8900ACBGLO
UPC CODE: 810053673041
EAN CODE: 8435394778778

FEATURE

- Sound and Light Instruction.
- Double Molded Case.
- Operating Temperature 0°C~50°C.

SPECIFICATIONS

AC Voltage
90~1000V

Frequency
50Hz~60Hz

Humidity
85%RH

Altitude
<2000m

MAIN APPLICATIONS

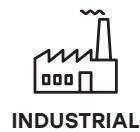
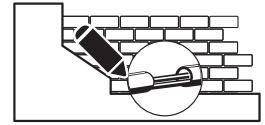

CONTENTS



157×24×20mm
6.18"×0.94"×0.78"
42g/0.09lb



2×1.5V AAA
Batteries



ACCESSORIES

Battery



Calibration
Certificate



Quick Start
Guide

PACKAGING INFORMATION



Color Box
L82×W40×H184mm



Carton Box
39×22×35.5cm



X 40PCS



NON CONTACT AC VOLTAGE DETECTOR
MS8900C

SKU NO.: MS8900CCBGLO
UPC CODE: 810053675373
EAN CODE: 8435394783413

FEATURE

- Sound and Light Instruction.
- Double Molded Case.
- Operating Temperature 0°C~50°C.

SPECIFICATIONS

AC Voltage 100~240V	Frequency 50Hz~60Hz	Humidity 85%RH
Altitude <2000m		

MAIN APPLICATIONS

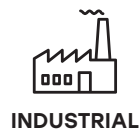
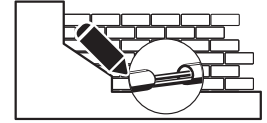

CONTENTS



157×24×20mm
6.18"×0.94"×0.78"
42g/0.09lb



2×1.5V AAA
Batteries



ACCESSORIES

Battery



Calibration
Certificate



Quick Start
Guide

PACKAGING INFORMATION



Color Box
L82×W40×H184mm



Carton Box
39×22×35.5cm



X 40PCS



NON CONTACT AC VOLTAGE DETECTOR MS8902A

SKU NO.: MS8902ACBGLO
UPC CODE: 810053672730
EAN CODE: 8435394778372

FEATURE

- Sound and Light Instruction.
- Double Molded Case.
- Operating Temperature 0°C~50°C.

SPECIFICATIONS

AC Voltage
12~1000V

Frequency
50Hz~500Hz

Humidity
85%RH

Altitude
<2000m

MAIN APPLICATIONS

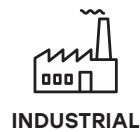
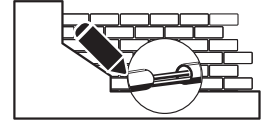

CONTENTS



157×24×20mm
6.18"×0.94"×0.78"
42g/0.09lb



2×1.5V AAA
Batteries



Battery

ACCESSORIES



Calibration
Certificate



Quick Start
Guide

PACKAGING INFORMATION



Color Box
L82×W40×H184mm



Carton Box
39×22×35.5cm



X 40PCS



MAIN APPLICATIONS

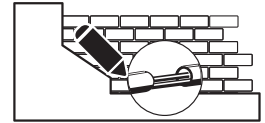

NON CONTACT AC VOLTAGE DETECTOR
MS8902B

SKU NO.: MS8902BCBGLO
UPC CODE: 810053674505
EAN CODE: 8435394779577

FEATURE

- Sound and Light Instruction.
- Double Molded Case.
- Operating Temperature 0°C~50°C.

SPECIFICATIONS

AC Voltage
20~1000V

Frequency
50Hz~500Hz

Humidity
85%RH

Altitude
<2000m

CONTENTS



157×24×20mm
6.18"×0.94"×0.78"
42g/0.09lb



1×12V A23S
Battery



ACCESSORIES

Battery



Calibration
Certificate



Quick Start
Guide

PACKAGING INFORMATION



Color Box
L82×W40×H184mm



Carton Box
39×22×35.5cm



X 40PCS



NON CONTACT AC VOLTAGE DETECTOR MS8907

SKU NO.: MS8907CBGLO
UPC CODE: 810053674789
EAN CODE: 8435394779843

FEATURE

- Sound and Light Instruction.
- Work Light.
- Operating Temperature $-10^{\circ}\text{C}\sim 50^{\circ}\text{C}$.

SPECIFICATIONS

AC Voltage
50~1000V

Frequency
50Hz/60Hz

Humidity
85%RH

Altitude
<2000m

MAIN APPLICATIONS

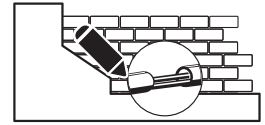

CONTENTS



157×24×20mm
6.2"×0.95"×0.79"
42g/0.09lb



2×1.5V AAA
Batteries



ACCESSORIES

Battery



Calibration
Certificate



Quick Start
Guide

PACKAGING INFORMATION



Color Box
L82×W40×H184mm



Carton Box
39×22×35.5cm



X 40PCS



MAIN APPLICATIONS

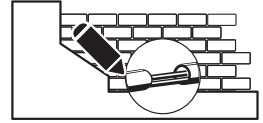

VOLTAGE TESTER

MS8922A

SKU NO.: MS8922ACBGLO
 UPC CODE: 810053674529
 EAN CODE: 8435394779591

FEATURE

- Ergonomic Design That Facilitates Its Use.
- Operation Time Maximum 30s.
- Recovery Time 10 Minutes.

SPECIFICATIONS

AC Voltage 400V	DC Voltage 400V	Frequency 50Hz/60Hz
Altitude <2000m		

CONTENTS



223×40×32mm
 8.78"×1.57"×1.26"
 98.5g/0.26lb



Calibration Certificate



Quick Start Guide

PACKAGING INFORMATION



Color Box
 L125×W40×H255mm



Carton Box
 53×25×27cm



X 20PCS



VOLTAGE TESTER WITH RCD MS8922B

SKU NO.: MS8922BCBGLO
UPC CODE: 810053674536
EAN CODE: 8435394779607

FEATURE

- RCD Test Function.
- Operation Time Maximum 30s.
- Recovery Time 10 Minutes.
- Operation Temperature -10~55°C/14~131°F.

SPECIFICATIONS

AC Voltage
400V

DC Voltage
400V

Frequency
50Hz/60Hz

Altitude
<2000m

MAIN APPLICATIONS

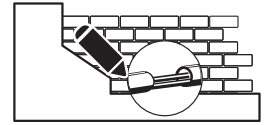

CONTENTS



223×40×32mm
8.78"×1.57"×1.26"
98.5g/0.26lb



Calibration
Certificate



Quick Start
Guide

PACKAGING INFORMATION



Color Box
L125×W40×H255mm



Carton Box
53×25×27cm



X 20PCS

CIRCUIT TESTERS

WIRE TESTERS AND TRACKER | SOCKET TESTER
CIRCUIT BREAKER FINDER





3 WIRE / GFCI OUTLET TESTER MS102

SKU NO.: MS102CBGLO
UPC CODE: 810053675038
EAN CODE: 8435394783031

FEATURE

- Quick and Easy Tool to Use to Make Sure That An Outlet or GFCI Is Safe for Use.

SPECIFICATIONS

AC Voltage
125V

Temperature
0~40°C

Humidity
<80% RH

MAIN APPLICATIONS



DOMESTIC

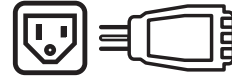

CONTENTS



82×42×32mm
3.2"×1.65"×1.26"
45g/0.1lb



Calibration
Certificate



Quick Start
Guide

PACKAGING INFORMATION



Color Box
L88×W65×H100mm



Carton Box
34.5×22×38cm



X 40PCS



3 WIRE OUTLET TESTER
MS112

SKU NO.: MS112CBGLO
UPC CODE: 810053675045
EAN CODE: 8435394783048

FEATURE

- Quick and Easy Tool to Use to Make Sure That An Outlet or GFCI Is Safe for Use.

SPECIFICATIONS

AC Voltage 125V	Temperature 0~40°C	Humidity <80% RH
---------------------------	------------------------------	-------------------------------

MAIN APPLICATIONS

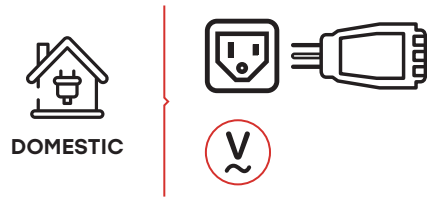

CONTENTS

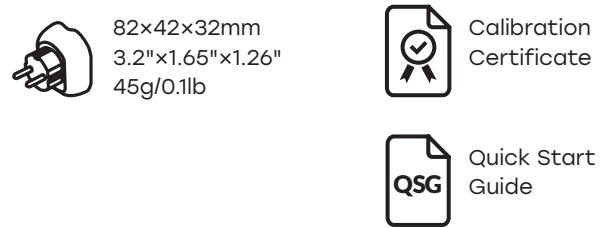

PACKAGING INFORMATION

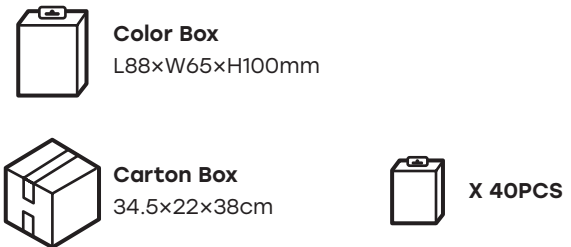



MS5902RTD



MS5902RTE



MS5902RTF

CIRCUIT BREAKER FINDER

MS5902RT

SKU NO.	MS5902RTDCBGLO	MS5902RTECBGLO	MS5902RTFCBGLO
UPC CODE	810053672877	810053675106	810053674727
EAN CODE	8435394778556	8435394783093	8435394779782

FEATURE

- Socket Tester and Circuit Breaker Finder.
- Sound and Light Signals.
- Professional Reference.

SPECIFICATIONS

AC Voltage(TD)	AC Voltage(TE)	AC Voltage(TF)
230V	230V	120V

MAIN APPLICATIONS

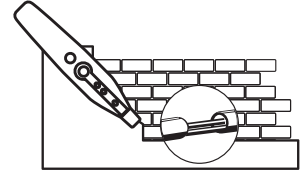
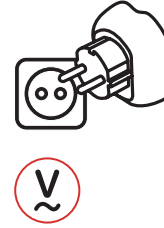

CONTENTS



MS5902R:
198×40×50mm
7.8"×1.57"×1.97"
126g/0.28lb

MS5902TD/TE:
71×64×55mm
2.8"×2.5"×2.16"
60g/0.13lb

MS5902TF:
82×42×32mm
3.2"×1.65"×1.26"
35g/0.1lb



Carry bag

ACCESSORIES



1×9V 6F22
Battery



Calibration
Certificate



Quick Start
Guide

PACKAGING INFORMATION



Color Box
L130×W63×H255mm



Carton Box
53×34×28.5cm



X 20PCS



MS5905TD



MS5905RTE

MAIN APPLICATIONS

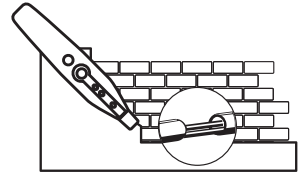
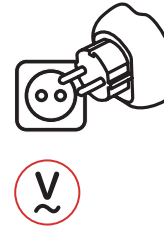

CONTENTS



MS5905R:
177×46×31mm
6.97"×1.81"×1.22"
130g/0.29lb

MS5905TD/TE:
71×64×55mm
2.8"×2.5"×2.16"
63g/0.14lb



Carry bag
Battery



1×9V 6F22
Battery



Calibration
Certificate



Quick Start
Guide

CIRCUIT BREAKER FINDER with NCV
MS5905RT

SKU NO.	MS5905RTDCBGLO	MS5905RTECBGLO
UPC CODE	810053675120	810053673126
EAN CODE	8435394783116	8435394778853

FEATURE

- Socket Tester and Circuit Breaker Finder.
- Sound and Light Signals.
- Professional Reference.

SPECIFICATIONS

AC Voltage(TD)	AC Voltage(TE)
230V	230V

PACKAGING INFORMATION



Color Box
L130×W63×H255mm



Carton Box
53×34×28.5mm



X 20PCS



MS6860D



MS6860E

SOCKET TESTER

MS6860

SKU NO.	MS6860DCBGLO	MS6860ECBGLO
UPC CODE	810053674369	810053675281
EAN CODE	8435394779430	8435394783307

FEATURE

- Reliable and Easy to Use Modern, Ergonomic Design with Unique Soft Finger Grip Compact, Durable-Designed to Safety Standard EN61010.

SPECIFICATIONS

AC Voltage(MS6860D)
230V

AC Voltage(MS6860E)
230V

MAIN APPLICATIONS



CONTENTS

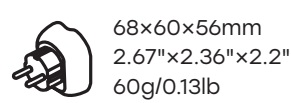

PACKAGING INFORMATION

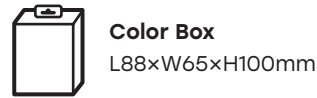

CIRCUIT ANALYZERS

MOTOR & PHASE ROTATION INDICATOR
CIRCUIT ANALYZER



MASTECH MS5900
MOTOR&PHASE ROTATION INDICATOR

U L1/A V L2/B W L3/C

CAT III 600V

SENSOR M SENSOR

L R

ON

OFF NOT DEFINED

ON L1=A, L2=B, L3=C

DISPLAY	Rotat.Right	Rotat.Left	L1 MISSING	L2 MISSING	L3 MISSING
☐	⊕	⊖	⊗	⊗	⊗
⊗	⊕	⊖	⊗	⊗	⊗
⊕	⊖	⊕	⊗	⊗	⊗
⊖	⊕	⊖	⊗	⊗	⊗

U_m=400/230V AC U_mmax=1...400V AC f_m=2...400Hz
L1=L2=L3 3.5mA/400V CONTINUOUS OPERATION
IEC 61557-7

MASTECH

L1/A U L2/B V L3/C W

△ CAT III 600V

SENSOR M SENSOR

L R

ON

MS5901
MOTOR & PHASE ROTATION INDICATOR

☐ ON ○ OFF ⊗ NOT DEFINED

DISPLAY	Rotat.Right	Rotat.Left	L1 MISSING	L2 MISSING	L3 MISSING
☐	⊕	⊖	⊗	⊗	⊗
⊗	⊕	⊖	⊗	⊗	⊗
⊕	⊖	⊕	⊗	⊗	⊗
⊖	⊕	⊖	⊗	⊗	⊗

U_m=400/230V AC U_mmax=1...400V AC f_m=2...400Hz
L1=L2=L3 3.5mA/400V CONTINUOUS OPERATION

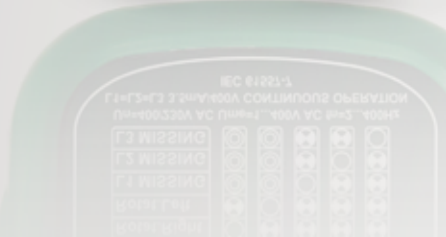



MAIN APPLICATIONS

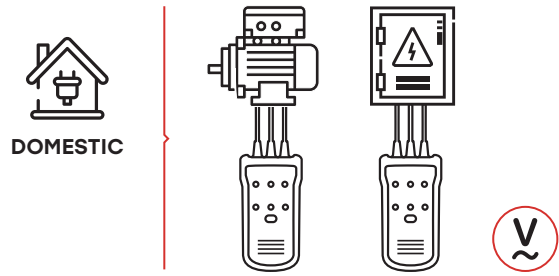

CONTENTS

- 130x72x32mm
5.1"x2.8"x1.3"
193g/0.43lb
- 1x9V 6F22 Battery
- Test alligator clips
Carry bag
Battery
- Calibration Certificate
- Quick Start Guide

MOTOR & PHASE ROTATION INDICATOR
MS5900

SKU NO.: MS5900CBGLO
UPC CODE: 810053672006
EAN CODE: 8435394777733

FEATURE

- Motor & phase rotation tester.
- Led light signals.
- Operating Altitude 2000m.
- Pollution Degree 2.

SPECIFICATIONS

AC Voltage() 120~400V	Frequency 2~400Hz
---------------------------------	-----------------------------

PACKAGING INFORMATION

- Color Box**
L168xW64xH238mm
- Carton Box**
49.5x37x35.5cm
- X 20PCS**



MAIN APPLICATIONS

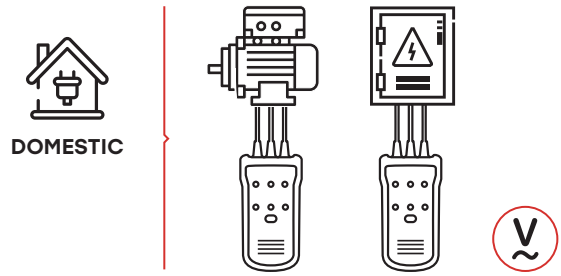

CONTENTS

- 130x72x32mm
5.1"x2.8"x1.3"
193g/0.43lb
- 1x9V 6F22 Battery
- Test alligator clips
Carry bag
Battery
- Calibration Certificate
- Quick Start Guide

MOTOR & PHASE ROTATION INDICATOR
MS5901

SKU NO.: MS5901CBGLO
UPC CODE: 810053672921
EAN CODE: 8435394778655

FEATURE

- Motor & phase rotation tester.
- Led light signals.
- Operating Altitude 2000m.
- Pollution Degree 2.

SPECIFICATIONS

AC Voltage 120~400V	Frequency 2~400Hz
-------------------------------	-----------------------------

PACKAGING INFORMATION





- Color Box**
L168xW64xH238mm
- Carton Box**
51x36x36cm
- X 20PCS**

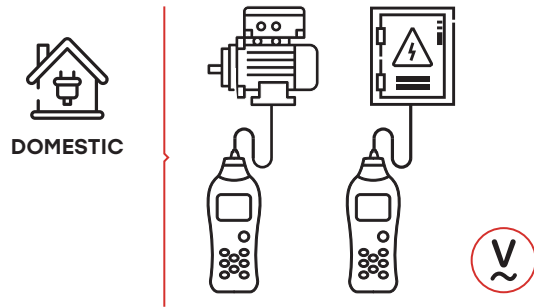

MAIN APPLICATIONS



CONTENTS

-  194x78x37mm
7.64"x3.07"x1.46"
254g/0.56lb
-  6x1.5V AAA Batteries
-  Power Cord
Carry bag
Battery
-  Calibration Certificate
-  QSG Quick Start Guide

CIRCUIT ANALYZER

MS5908A

SKU NO.: MS5908ACBGLO
UPC CODE: 810053673119
EAN CODE: 8435394778846



FEATURE

- Auto Power Off.
- Data Hold.
- Low Battery Display.

SPECIFICATIONS

Line Voltage 85~135V	Peak Line Voltage 120~190V	Frequency 45~65Hz
Voltage Drop Load Current 12/15/20A	RCD Trip Time 1ms~6.5S	
RCD Trip Current 30mA~37mA	GFCI Trip Time 1ms~6.5S	GFCI Trip Current 6mA~9mA

PACKAGING INFORMATION

-  **Color Box**
L130xW63xH255mm
-  **Carton Box**
53x34x28.5mm
-  **X 20PCS**



MAIN APPLICATIONS

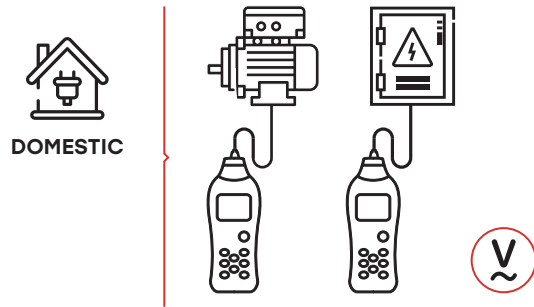

CONTENTS

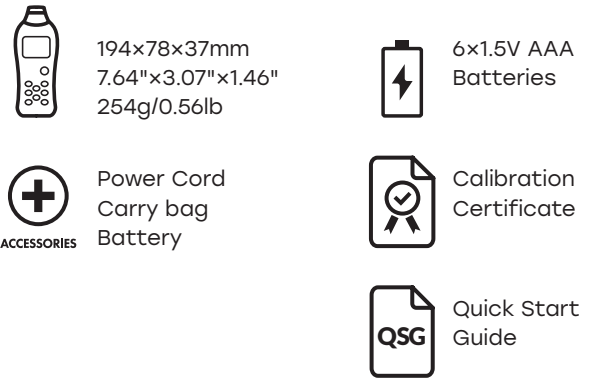

CIRCUIT ANALYZER

MS5908C

SKU NO.: MS5908CCBGLO
 UPC CODE: 810053672808
 EAN CODE: 8435394778440

FEATURE

- Auto Power Off.
- Data Hold.
- Low Battery Display.

SPECIFICATIONS

Line Voltage 85~265V	Peak Line Voltage 120~375V	Frequency 45~65Hz
Voltage Drop Load Current 5/8/10A	RCD Trip Time 1ms~6.5S	
RCD Trip Current 30mA~37mA	GFCI Trip Time 1ms~6.5S	GFCI Trip Current 6mA~9mA

PACKAGING INFORMATION

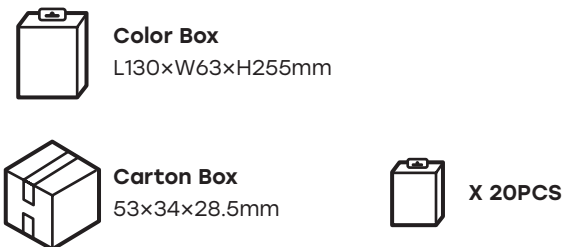

WIRE & CABLE TESTERS

NETWORK CABLE TESTER | CABLE TRACKER

MULTI-FUNCTIONS CABLE TRACKER | ADVANCED CABLE LOCATOR





MAIN APPLICATIONS

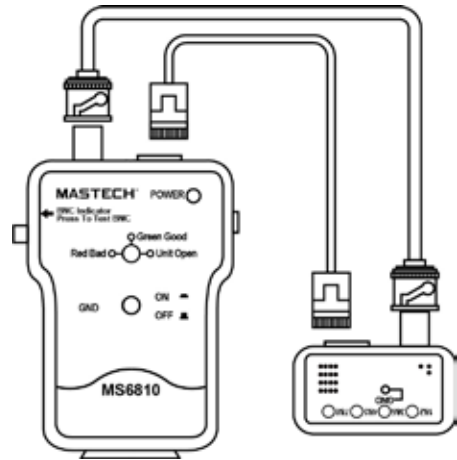

NETWORK CABLE TESTER
MS6810

SKU NO.: MS6810CBGLO
UPC CODE: 810053674345
EAN CODE: 8435394779416

FEATURE

- Widely Used For Coaxial Cable (BNC), UTP And STP Cable. It Can Automatically Check For Open Circuits, Shorts, Miswired, And Reversals.

SPECIFICATIONS

Distance
200m(max)

CONTENTS



153×74×31mm
6.0"×2.9"×1.2"
120g/0.26lb



1×9V 6F22
Battery



Carry bag
Battery

ACCESSORIES



Calibration
Certificate



Quick Start
Guide

PACKAGING INFORMATION



Color Box
L90×W40×H165mm



Carton Box
42.5×35×29cm



X 60PCS



NETWORK CABLE TESTER
MS6811

SKU NO.: MS6811CBGLO
UPC CODE: 810053672624
EAN CODE: 8435394778266

FEATURE

- Tests for Open Circuits, Shorts, Miswires, Reversals, and Split Pairs.
- DEBUG Quickly Identifies Which Cable Pairs Have A Specific Wiring Fault.

SPECIFICATIONS

Distance
200m(max)

MAIN APPLICATIONS

Fault details

Fig.1 SPLIT PAIRS

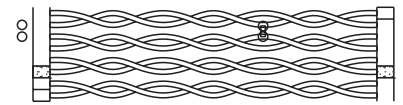

Fig.2 SHORT

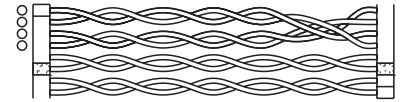

Fig.3 MISWIRE

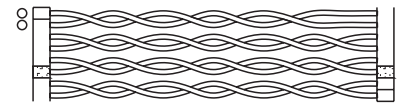
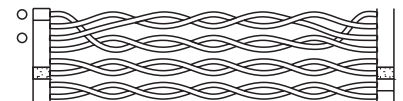

Fig.4 REVERSED



CONTENTS



125×55×30mm
4.9"×2.2"×1.2"
106g/0.23lb



1×6V 4LR44/
4AG13 Battery



Carry bag
Battery

ACCESSORIES



Calibration
Certificate



Quick Start
Guide

PACKAGING INFORMATION



Color Box
L90×W40×H165mm



Carton Box
42.5×35×29cm



X 60PCS



CABLE TRACKER
MS6812A

SKU NO.: MS6812ACBGLO
UPC CODE: 810053675274
EAN CODE: 8435394783291

FEATURE

- Sound and Light Instruction.
- Cont and Tone LED Light.

SPECIFICATIONS

Send Tone Frequency
1.5kHz

Receive Frequency
100Hz~300kHz

MAIN APPLICATIONS

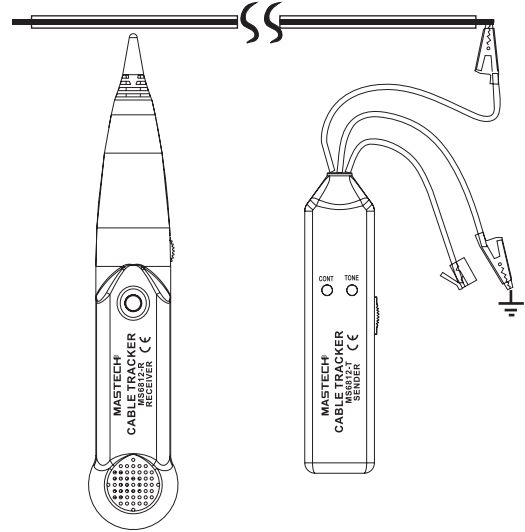

CONTENTS



Receiver:
238×43×26mm
9.4"×1.7"×1.0"
71g/0.16lb



Emitter:
145×35×25mm
5.7"×1.38"×0.98"
87g/0.2lb



ACCESSORIES

Carry bag
Battery



2x9V 6F22
Batteries



Calibration
Certificate



Quick Start
Guide

PACKAGING INFORMATION



Color Box
L125×W40×H255mm



Carton Box
53×22×27cm



X 20PCS



MULTI-FUNCTIONS CABLE TRACKER
MS6813

SKU NO.: MS6813CBGLO
UPC CODE: 810053672976
EAN CODE: 8435394778709

FEATURE

- Multifunction.
- Cable tester and tracker.
- State of the telephone lines.
- Small size ideal for transport.

SPECIFICATIONS

Receive Frequency
100Hz~300kHz

Send Tone Frequency
1.5kHz

MAIN APPLICATIONS

Fig.1 SHORT

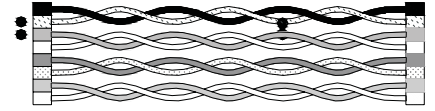

Fig.2 MISWIRE



Fig.3 REVERSED



Fig.4 SPLIT PAIRS



CONTENTS



206×84×55mm
8.1"×3.3"×2.1"
330g/0.72lb



2×9V 6F22
Batteries



ACCESSORIES

Carry bag
Battery



Calibration
Certificate



Quick Start
Guide

PACKAGING INFORMATION



Color Box
L172×W80×H255mm



Carton Box
46×27×37cm



X 10PCS



MAIN APPLICATIONS

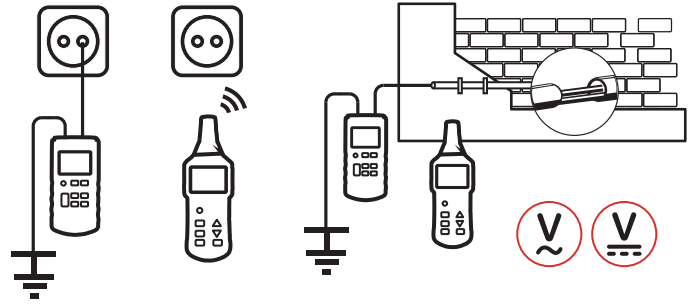

CONTENTS



Transmitter:
190×89×42.5mm
7.48"×3.5"×1.67"
420g/0.92lb



Receiver:
241.5×78×38.5mm
9.5"×3"×1.5"
350g/0.77lb



ACCESSORIES

Test leads
Test probe
Alligator clip
Grounding rod
Carry bag
Battery



1×9V 6F22 Battery/
6×1.5V AAA
Batteries



Calibration
Certificate



Quick Start
Guide

ADVANCED WIRE TRACKER
MS6818

SKU NO.: MS6818CBGLO
UPC CODE: 810053672204
EAN CODE: 8435394777924

FEATURE

- Track Cables In The Wall or Earth.
- One or Dual-pole Application.
- Adjustable Sensitivity In Transmitter and Receiver.

SPECIFICATIONS

AC Voltage
12~400V

DC Voltage
12~400V

Output Signal
125kHz

Display Counts
2000

PACKAGING INFORMATION



Color Box
L200xW85xH280mm



Carton Box
44.5x32.5x42cm



X 10PCS

LCR METERS

DIGITAL LCR METER | SMART SMD TESTER





DIGITAL LCR METER WITH USB INTERFACE
MS5308

SKU NO.: MS5308CBGLO
 UPC CODE: 810053673102
 EAN CODE: 8435394778839

FEATURE

- Auto & Manual Ranging.
- Auto Power off.
- LCR smart check and measurement.
- DCR mode.

SPECIFICATIONS

Resistance 200Ω	Capacitance 2000μF	LCR 2000H
---------------------------	------------------------------	---------------------

MAIN APPLICATIONS

ELECTRONICS

CONTENTS

	224x172x58mm 8.8"x6.8"x2.3" 841g/1.85lb		8x1.5 AA Batteries
	Kelvin test clip SMD test probe IR data line Software CD Battery		Calibration Certificate
External power supply (option)			Quick Start Guide

PACKAGING INFORMATION

	Color Box L320xW125xH255mm	
	Carton Box 52x33.5x29cm	X 4PCS



DIGITAL LCR METER

MS6013

SKU NO.: MS6013CBGLO
 UPC CODE: 810053674222
 EAN CODE: 8435394779294

FEATURE

- Zero Adjustment approx. $\pm 20\text{pF}$.
- Input Jacks.
- High Accuracy in Measuring.
- Low Battery Display.

SPECIFICATIONS

Capacitance 200pF~20mF	Display Counts 2000
----------------------------------	-------------------------------

MAIN APPLICATIONS

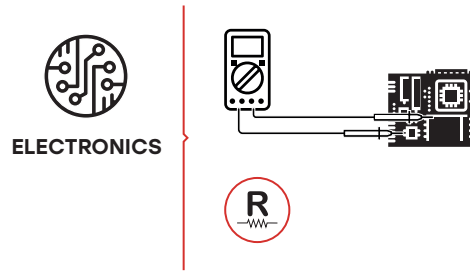

CONTENTS

- 189x91x31.5mm
7.4"x3.6"x1.2"
240g/0.52lb
- 1x9V 6F22 Battery
- Test Leads
Carry bag
Battery
- Calibration Certificate
- Quick Start Guide

PACKAGING INFORMATION

- Color Box**
L165xW70xH225mm
- Carton Box**
47x37.5x35.5cm
- X 20PCS**



SMART SMD TESTER (R/C)
MS8910

SKU NO.: MS8910CBGLO
UPC CODE: 810053672747
EAN CODE: 8435394778389

FEATURE

- Auto Ranging.
- Auto Power Off.
- Data Hold.
- Low Battery Display.

SPECIFICATIONS

Resistance 30MΩ	Capacitance 30mF	Display Counts 3000
Continuity 30Ω		

MAIN APPLICATIONS

ELECTRONICS

CONTENTS

175x32x20mm 6.89"x1.26"x0.79" 48g/0.10lb	1x3V CR2032 Battery
Spare test pin Battery	Calibration Certificate
ACCESSORIES	Quick Start Guide

PACKAGING INFORMATION

Color Box L57xW29xH203mm	
Carton Box 44x32x31.5cm	X 100PCS



SMART SMD TESTER (R/C/L)
MS8911

SKU NO.: MS8911CBGLO
UPC CODE: 810053674512
EAN CODE: 8435394779584

FEATURE

- Auto Ranging.
- Auto Power Off.
- Data Hold.
- Low Battery Display.

SPECIFICATIONS

Resistance 20MΩ	Capacitance 6mF	Inductance 200H
Display Counts 6000		

MAIN APPLICATIONS

ELECTRONICS

CONTENTS

186×35×23.6mm 7.3"×1.38"×0.93" 90g/0.2lb	1×3V CR2450 Battery
Spare test pin Battery ACCESSORIES	Calibration Certificate
	Quick Start Guide

PACKAGING INFORMATION





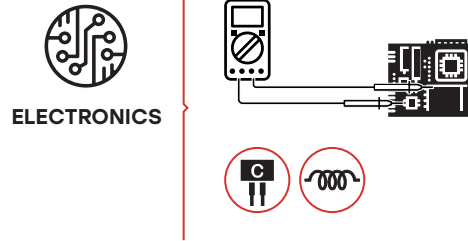

Color Box L57×W29×H203mm	
Carton Box 44×32×31.5cm	X 100PCS



MAIN APPLICATIONS



CONTENTS

-  189×91×31.5mm
7.4"×3.6"×1.2"
240g/0.52lb
-  1×9V 6F22
Battery
-  Test Leads
-  Calibration
Certificate
-  ACCESSORIES
-  QSG
Quick Start
Guide

DIGITAL LCR METER

MY6243

SKU NO.: MY6243CBGLO
UPC CODE: 810053672754
EAN CODE: 8435394778396



FEATURE

- Input Jacks.
- High Accuracy in Measuring.
- Low Battery Display.

SPECIFICATIONS

Capacitance 200µF	Inductance 2H	Display Counts 2000
-----------------------------	-------------------------	-------------------------------

PACKAGING INFORMATION

-  **Color Box**
L165×W70×H225mm
-  **Carton Box**
47×37.5×35.5cm
-  **X 20PCS**

EARTH RESISTANCE

EARTH RESISTANCE CLAMP METER | EARTH RESISTANCE TESTER
ADVANCED EARTH RESISTANCE TESTER





EARTH RESISTANCE CLAMP METER
MS2115A

SKU NO.: MS2115ACBGLO
UPC CODE: 810053672051
EAN CODE: 8435394777788

FEATURE

- Auto Power Off.
- Low Battery Display.
- MAX/MIN.

SPECIFICATIONS

AC Voltage 750V	DC Voltage 1000V	AC Current 1000A
DC Current 1000A	Resistance 60MΩ	Capacitance 100mF
Frequency 1000Hz	Display Counts 6000	Continuity <50Ω

MAIN APPLICATIONS

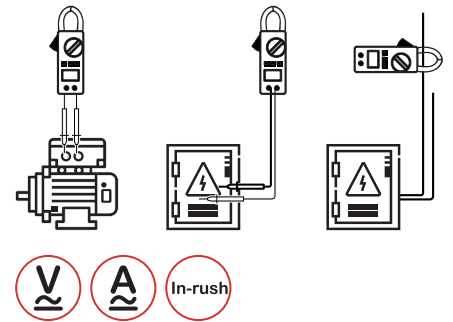
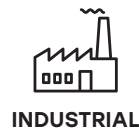
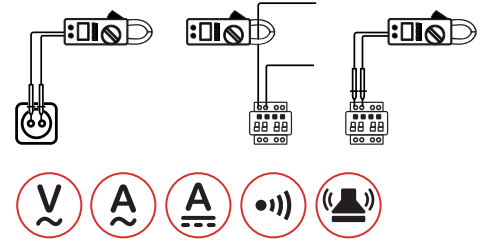

CONTENTS



238×92×50mm
9.3"×3.62"×1.96"
420g/0.7lb



1×9V 6F22
Battery



ACCESSORIES

Test Leads
Carry bag
Battery



Calibration
Certificate



Quick Start
Guide

PACKAGING INFORMATION



Color Box
L130×W63×H255mm



Carton Box
53×34×28.5mm



X 20PCS



MAIN APPLICATIONS



DOMESTIC

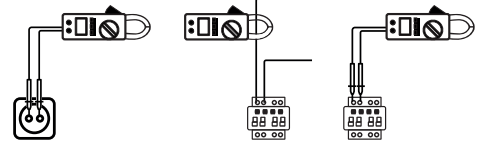

INDUSTRIAL

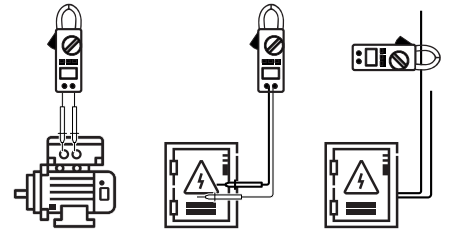

EARTH RESISTANCE CLAMP METER
MS2301

SKU NO.: MS2301CBGLO
UPC CODE: 810053674208
EAN CODE: 8435394779270

FEATURE

- Auto & Manual Ranging.
- Logging and Recall 99 Groups.
- Setting Alarm Threshold in 1~100Ω.

SPECIFICATIONS

Resistance 1200Ω	AC Current 20A	Display Counts 9999
Jaw Opening 45mmx32mm/1.8"x1.3"		Data Logging 99 groups

CONTENTS



276x104x54mm
10.8"x4.33"x2.1"
1050g/2.31lb



1x9V Alkaline Battery



Calibration loop of resistance (1Ω/5Ω/10Ω)
Carry case
Battery



Calibration Certificate



Quick Start Guide

PACKAGING INFORMATION



Color Box
L370xW140xH324mm



Carton Box
58x39x35cm



X 4PCS



EARTH RESISTANCE TESTER

MS2302

SKU NO.: MS2302CBGLO
 UPC CODE: 810053672150
 EAN CODE: 8435394777870

FEATURE

- Auto & Manual Ranging.
- Auto Power Off.
- Segments Bar Graph.
- MAX/MIN/AVG.

SPECIFICATIONS

Earth Voltage
AC 0~200V

Earth Resistance
0.01~4000Ω

MAIN APPLICATIONS

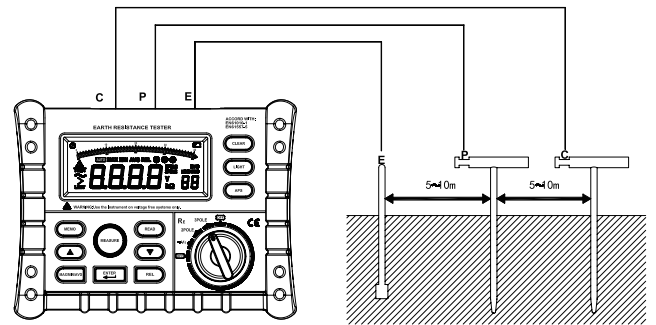
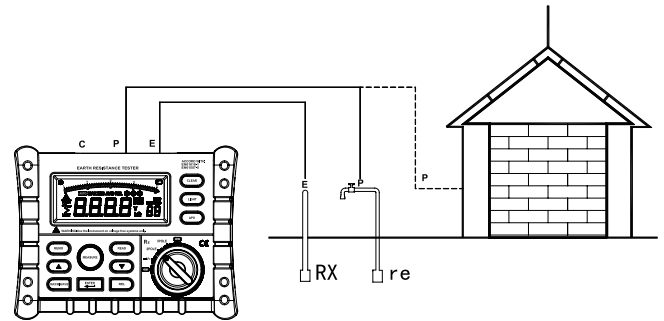

CONTENTS



330×265×125mm
 13"×10.4"×4.9"
 900g/1.98lb



6×1.5V AA
 Batteries



ACCESSORIES

Test leads (Red-15m/
 Green-10m/Black-5m)
 Wrapping bag
 Auxiliary earth bar
 Battery



Calibration
 Certificate



Quick Start
 Guide

PACKAGING INFORMATION



Color Box
 L325×W125×H255mm



Carton Box
 52×33.5×29cm



X 4PCS



ADVANCED EARTH RESISTANCE TESTER
MS2306

SKU NO.: MS2306CTGLO
 UPC CODE: 810053675069
 EAN CODE: 8435394783079

FEATURE

- Auto Power Off.
- Alarming indicator for limit-value measurement.
- AVG.
- Compensation Resistance.

SPECIFICATIONS

3 Pole & 4 Pole Earthing-Resistance Test
0.1Ω~20kΩ

2 Pole R (AC)
0.1Ω~20kΩ

Soil Resistivity ρ
0.02~1000

MAIN APPLICATIONS

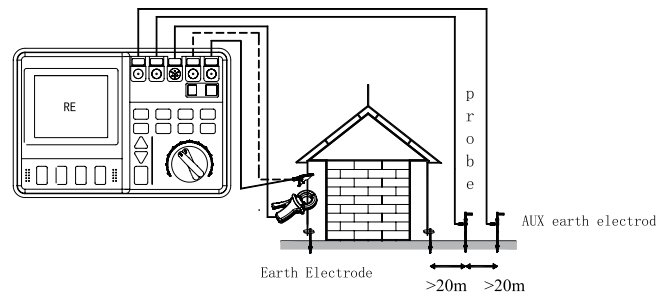
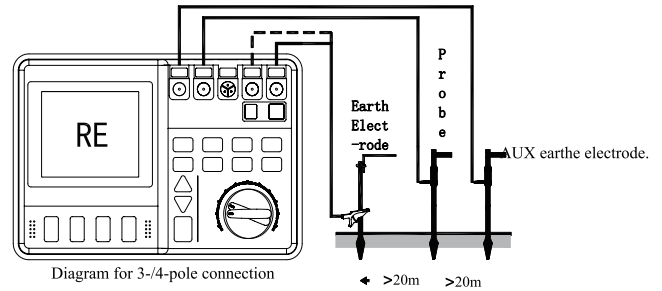

CONTENTS



284×230×125mm
 11.2"×9.1"×4.9"
 2.5kg/5.5lb



6×1.5V AA Batteries/
 NI~MH Recharge
 Battery, 7.2V



ACCESSORIES

Test wire
 Alligator clip
 Auxiliary earth bar
 Power cord
 Carry bag
 Battery



Calibration
 Certificate



Quick Start
 Guide

Rechargeable Ni-MH
 battery (optional)
 Charger (optional)

PACKAGING INFORMATION



Carton Box
 40×17.5×31.5cm



X 1PCS



ADVANCED EARTH RESISTANCE TESTER
MS2308

SKU NO.: MS2308CTGLO
 UPC CODE: 810053676790
 EAN CODE: 8435394785318

FEATURE

- Auto Power Off.
- Alarming indicator for limit-value measurement.
- AVG.
- Compensation Resistance.

SPECIFICATIONS

3 Pole & 4 Pole Earthing-Resistance Test 0.02Ω~300kΩ		
2 Pole R (AC) 0.02Ω~300kΩ	2 Pole R (DC) 0.02Ω~3kΩ	Soil Resistivity ρ 0.02~1000

MAIN APPLICATIONS

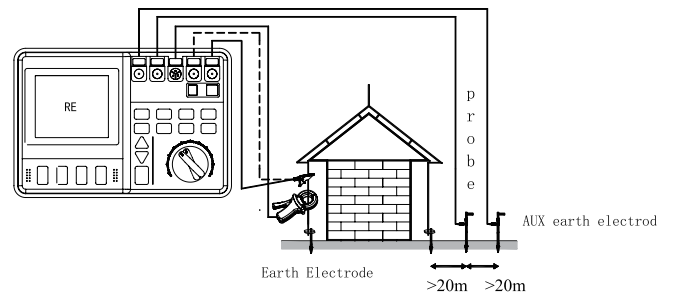
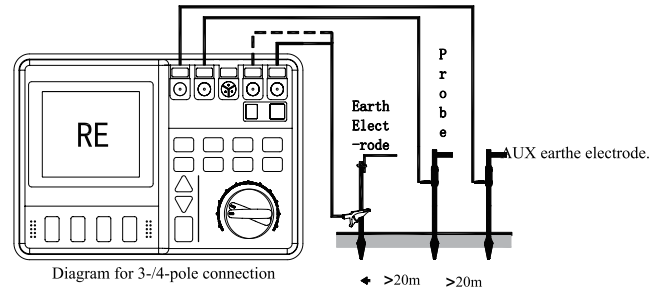

CONTENTS



284×230×125mm
 11.2"×9.1"×4.9"
 2.5kg/5.5lb



6×1.5V AA Batteries/
 Ni~MH Recharge Battery, 7.2V



ACCESSORIES

- Test wire
- Alligator clip
- Auxiliary earth bar
- Power cord
- Current transformer φ51mm
- Current clamp cable
- Carry bag
- Software CD
- USB interface cable
- Battery



Calibration Certificate



Quick Start Guide

- Rechargeable Ni-MH battery (optional)
- Charger (optional)

PACKAGING INFORMATION



Carton Box
 40×17.5×31.5cm



X 1PCS

INSULATION TESTERS

DIGITAL INSULATION TESTER | HIGH VOLTAGE DIGITAL INSULATION TESTER | ADVANCED HIGH VOLTAGE INSULATION TESTER





MAIN APPLICATIONS

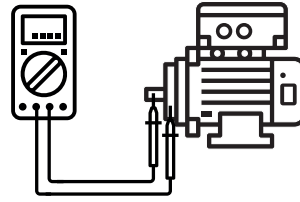

CONTENTS



192x122x55mm
7.48"x4.7"x2.2"
545g/1.3lb



6x1.5V AA
Batteries



ACCESSORIES

Test Leads
Test Clips
Screwdriver
Soft Case
Carrying Case
Battery



Calibration
Certificate



Quick Start
Guide

DIGITAL INSULATION TESTER
MS5201

SKU NO.: MS5201CBGLO
UPC CODE: 810053672884
EAN CODE: 8435394778617

FEATURE

- Data Hold.
- Low Battery Display.
- Constant Measuring Lock.

SPECIFICATIONS

AC Voltage 700V	DC Voltage 1000V	Resistance 2000MΩ
Display Counts 2000	Continuity <50Ω	

PACKAGING INFORMATION



Color Box
L370xW140xH324mm



Carton Box
58x39x35cm



X 4PCS



HIGH VOLTAGE INSULATION TESTER MS5202

SKU NO.: MS5202CBGLO
UPC CODE: 810053673072
EAN CODE: 8435394778808

FEATURE

- Inner Battery Testing.
- Low Battery Display.
- Constant Measuring Lock.

SPECIFICATIONS

DC Output
2500V

Resistance
0~100GΩ

MAIN APPLICATIONS

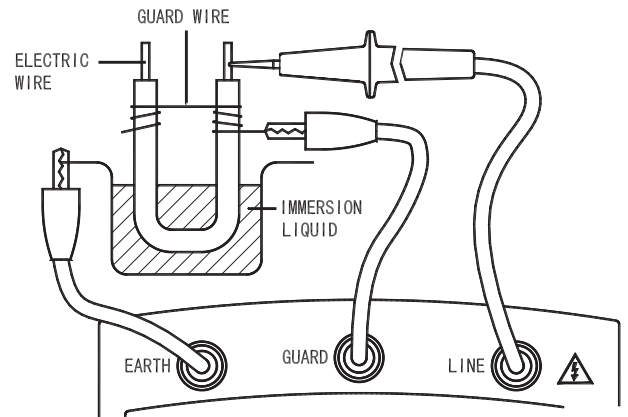

CONTENTS



225×138×81mm
8.86"×5.3"×3.19"
1200g/2.75lb



8×1.5V AA Batteries/
1×9V 6F22 Battery



ACCESSORIES

Test Clips
Carry bag
Battery



Calibration
Certificate



Quick Start
Guide

PACKAGING INFORMATION



Color Box
L370×W140×H324mm



Carton Box
58×39×35cm



X 4PCS



DIGITAL INSULATION TESTER
MS5203

SKU NO.: MS5203CBGLO
UPC CODE: 810053672587
EAN CODE: 8435394784328

FEATURE

- Auto Power Off.
- MIN/MAX/AVG.
- Compare Function.
- Timer.

SPECIFICATIONS

AC Voltage 750V	DC Voltage 1000V	DC Output 1000V
Resistance 200Ω		

MAIN APPLICATIONS

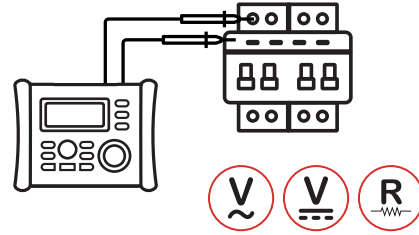

CONTENTS

- | | |
|---|----------------------------|
| 200x155x76mm
7.6"x5.9"x2.95"
900g/1.98lb | 6x1.5V AA
Batteries |
| Test Leads
Alligator clip
Wrapping bag
Battery | Calibration
Certificate |
| | Quick Start
Guide |

PACKAGING INFORMATION

- | | |
|--------------------------------------|--------|
| Color Box
L325xW125xH255mm | |
| Carton Box
52x33.5x29cm | X 4PCS |



DIGITAL INSULATION TESTER

MS5205

SKU NO.: MS5205CBGLO
 UPC CODE: 810053672907
 EAN CODE: 8435394778952

FEATURE

- Auto Power Off.
- Lock.
- MIN/MAX/AVG.
- Compare Function.

SPECIFICATIONS

AC Voltage
750V

DC Voltage
1000V

DC Output
2500V

Resistance
200Ω

MAIN APPLICATIONS

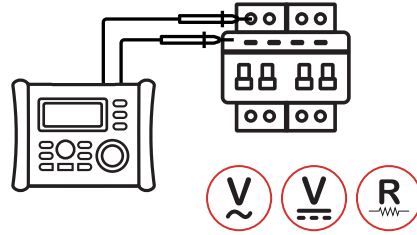

CONTENTS

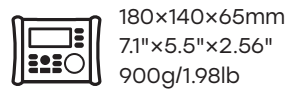

180×140×65mm
 7.1"×5.5"×2.56"
 900g/1.98lb



8×1.5V AA
 Batteries



ACCESSORIES

Test Leads
 Alligator clip
 Wrapping bag
 Battery



Calibration
 Certificate



Quick Start
 Guide

PACKAGING INFORMATION



Color Box
 L325×W125×H255mm



Carton Box
 52×33.5×29cm



X 4PCS



**ADVANCED HIGH VOLTAGE
INSULATION TESTER**
MS5215

SKU NO.: MS5215CBGLO
UPC CODE: 810053672914
EAN CODE: 8435394778648

FEATURE

- Broad Range Of Testing Voltage.
- Insulation Diagnosis.
- Large Storage Memory.
- Clear Display.

SPECIFICATIONS

AC Voltage 50~750V	DC Voltage 50~1000V	Resistance 0.01MΩ~5TΩ
Temperature -10°C~70°C		

MAIN APPLICATIONS

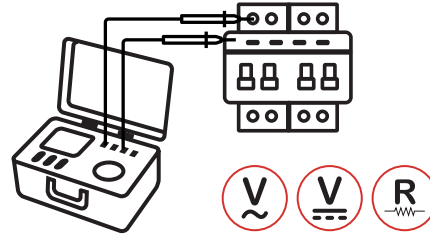

CONTENTS

- 284×230×125mm
11.2"×9.1"×4.9"
2426g/5.34lb
- 6×LR14 Batteries/
6×1.2V AA Batteries
- Charger:
Input Voltage
100V~240V
- Tester probes leads 3m
(Red/Black/Blue)
- Crocodile clips
(Red/Black/Blue)
- Temperature Sensor
- USB data line (1m)
- Data analysis software CD
- Instrument backpack
- Battery
- Rechargeable battery
pack(for charging
Ni-Hy battery)(optional)
- AC charger (optional)
- Calibration
Certificate
- Quick Start
Guide

PACKAGING INFORMATION

- Color Box**
L400×W175×H315mm
- Carton Box**
42×37×34cm
- X 2PCS**

THERMOMETERS

DIGITAL THERMOMETER | DIGITAL THERMO-HYGROMETER
NON-CONTACT INFRARED THERMOMETER





DIGITAL THERMOMETER
MS6500

SKU NO.: MS6500CBGLO
UPC CODE: 810053673089
EAN CODE: 8435394778815

FEATURE

- Sample Rate 500mS.
- Display 2000 counts.
- Data Hold.
- K-Type Thermocouple.

SPECIFICATIONS

Celcius -50°C~750°C	Fahrenheit -58°F~1382°F	Display Counts 2000
-------------------------------	-----------------------------------	-------------------------------

MAIN APPLICATIONS

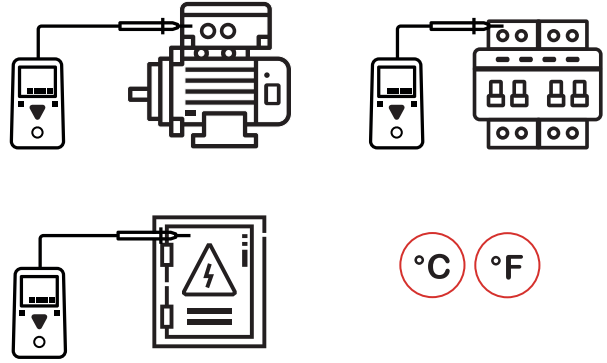

CONTENTS

125.5x72x27mm 5.6"x2.8"x1.0" 145g/0.30lb	1x9V 6F22 Battery
K type thermocouple Carry bag Battery	Calibration Certificate
	Quick Start Guide

PACKAGING INFORMATION

Color Box L105xW40xH145mm	
Carton Box 42x31.5x34cm	X 60PCS



DIGITAL THERMO-HYGROMETER
MS6505

SKU NO.: MS6505CBGLO
UPC CODE: 810053675229
EAN CODE: 8435394783222

FEATURE

- Auto Power Off.
- MAX/MIN.
- Clock.
- Data logging 16300 groups.

SPECIFICATIONS

Temperature
-20°C~60°C/-4°F~140°F

Display Counts
2000

MAIN APPLICATIONS

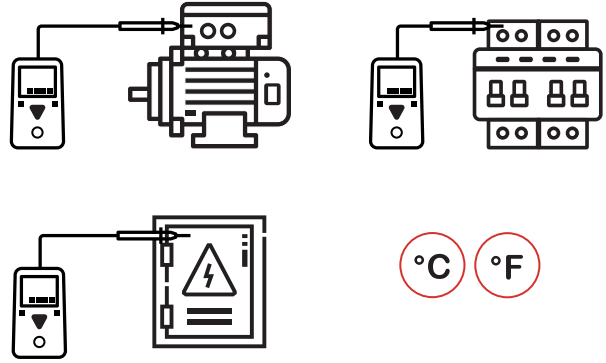

CONTENTS

- | | | | |
|--------------------|--|--|----------------------------|
| | 183x74x42mm
7.3"x2.9"x1.6"
330g/0.7lb | | 1x9V 6F22
Battery |
| | RS232 date line
Software CD
Carry bag
AC adapter
Battery | | Calibration
Certificate |
| ACCESSORIES | | | Quick Start
Guide |

PACKAGING INFORMATION

Color Box
L172xW80xH255mm

Carton Box
53x44.5x37cm

X 20PCS



MAIN APPLICATIONS

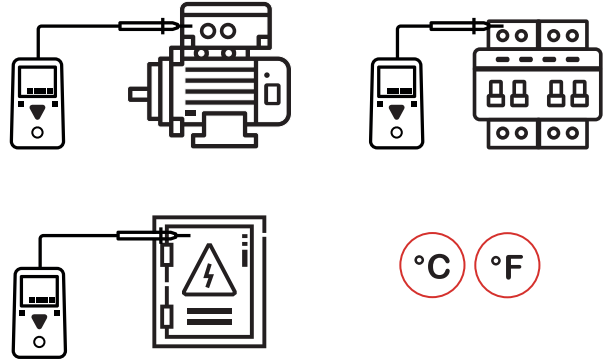

DIGITAL THERMOMETER
MS6511

SKU NO.: MS6511CBGLO
UPC CODE: 810053675243
EAN CODE: 8435394783246

FEATURE

- Auto Power Off.
- Data Hold.
- MAX/MIN/AVG.
- Low Battery Display.

SPECIFICATIONS

Type K, J, T, E	Channel TC
---------------------------	----------------------

CONTENTS

- 190x89x42mm
7.5"x3.5"x1.7"
350g/0.8lb
- 1x9V 6F22
Battery
- K type thermocouple
Battery
- Calibration
Certificate
- Quick Start
Guide

PACKAGING INFORMATION

- Color Box**
L165xW70xH225mm
- Carton Box**
47x37.5x35.5cm
- X 20PCS**



MAIN APPLICATIONS

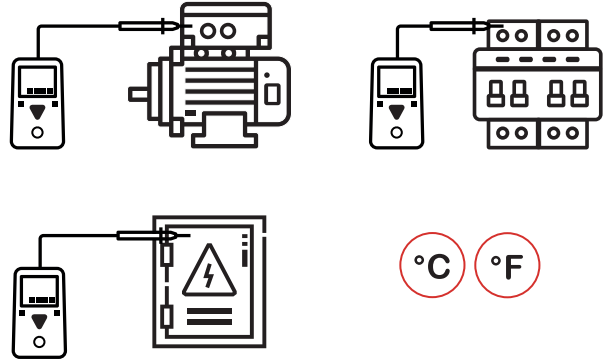

DIGITAL THERMOMETER
MS6512

SKU NO.: MS6512CBGLO
UPC CODE: 810053672945
EAN CODE: 8435394778679

FEATURE

- Auto Power Off.
- Data Hold.
- MAX/MIN/AVG.
- Low Battery Display.

SPECIFICATIONS

Type K, J, T, E	Channel T1/T2/T1-T2
---------------------------	-------------------------------

CONTENTS

190×89×42mm 7.5"×3.5"×1.7" 350g/0.8lb	1×9V 6F22 Battery
K type thermocouple Battery <small>ACCESSORIES</small>	Calibration Certificate
	Quick Start Guide

PACKAGING INFORMATION

Color Box L165×W70×H225mm	
Carton Box 47×37.5×35.5cm	X 20PCS



MAIN APPLICATIONS

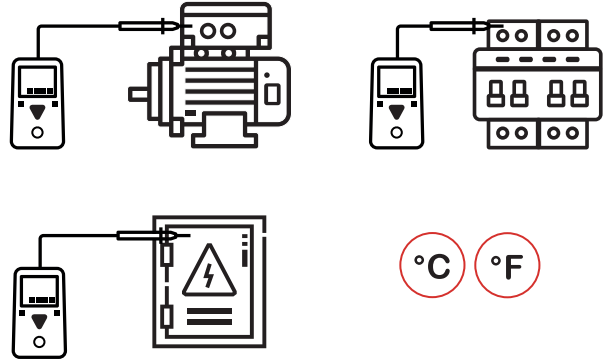

DIGITAL THERMOMETER
MS6513

SKU NO.: MS6513CBGLO
UPC CODE: 810053672044
EAN CODE: 8435394783253

FEATURE

- Auto Power Off.
- Data Hold.
- Memory Save Data.
- USB Interface.

SPECIFICATIONS

Type K, J, T, E, R, S, N	Channel TC
------------------------------------	----------------------

CONTENTS

- 190×89×42mm
7.5"×3.5"×1.7"
350g/0.8lb
- 1×9V 6F22 Battery
- K type thermocouple
- USB interface cable
- Software CD
- Battery
- Calibration Certificate
- Quick Start Guide

PACKAGING INFORMATION

- Color Box**
L165×W70×H225mm
- Carton Box**
47×37.5×35.5cm
- X 20PCS**



MAIN APPLICATIONS

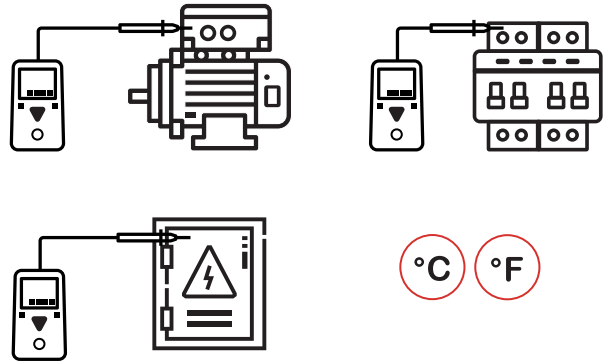

DIGITAL THERMOMETER
MS6514

SKU NO.: MS6514CBGLO
UPC CODE: 810053672037
EAN CODE: 843539477764

FEATURE

- Auto Power Off.
- Data Hold.
- Memory Save Data.
- USB Interface.

SPECIFICATIONS

Type K, J, T, E, R, S, N	Channel T1/T2/T1-T2
------------------------------------	-------------------------------

CONTENTS

190x89x42mm 7.5"x3.5"x1.7" 350g/0.8lb	1x9V 6F22 Battery
K type thermocouple USB interface cable Software CD Battery	Calibration Certificate
	Quick Start Guide

PACKAGING INFORMATION

Color Box L165xW70xH225mm	
Carton Box 47x37.5x35.5cm	X 20PCS



INFRARED THERMOMETER
MS6522A

SKU NO.: MS6522ACBGLO
UPC CODE: 810053674567
EAN CODE: 8435394779638

FEATURE

- Spectral Response 8-14 μm .
- Laser $\lt;1\text{mW}$/630-670nm.
- Response Time 1 Second.
- Relative Humidity 10%~90%

SPECIFICATIONS

Repeatability
 $\pm 0.1^{\circ}\text{C}$

Temperature
 $-20^{\circ}\text{C}\sim 300^{\circ}\text{C}/-4^{\circ}\text{F}\sim 572^{\circ}\text{F}$

Emissivity
0.95

MAIN APPLICATIONS

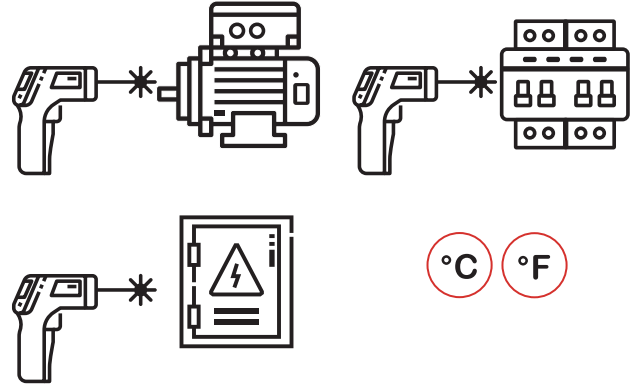

CONTENTS

143x99x47mm
5.6"x3.9"x1.85"
135g/0.3lb

2x1.5V AAA
Batteries

Battery
ACCESSORIES

Calibration
Certificate

Quick Start
Guide

PACKAGING INFORMATION

Color Box
L125xW55xH183mm

Carton Box
57.5x39.1x27.5cm

X 40PCS



INFRARED THERMOMETER
MS6522B

SKU NO.: MS6522BCBGLO
UPC CODE: 810053672617
EAN CODE: 8435394778914

FEATURE

- Spectral Response 8-14 μm .
- Laser <math><1\text{mW}</math>/630-670nm.
- Response Time 1 second.
- Relative Humidity 10%~90%

SPECIFICATIONS

Repeatability
 $\pm 0.1^{\circ}\text{C}$

Temperature
 $-20^{\circ}\text{C}\sim 500^{\circ}\text{C}/-4^{\circ}\text{F}\sim 932^{\circ}\text{F}$

Emissivity
0.95

MAIN APPLICATIONS

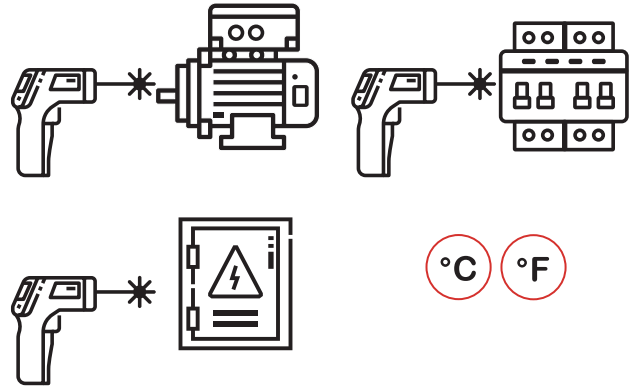

CONTENTS

 143x99x47mm
5.6"x3.9"x1.85"
135g/0.3lb

 2x1.5V AAA
Batteries

 Battery
ACCESSORIES

 Calibration
Certificate

 Quick Start
Guide

PACKAGING INFORMATION

 **Color Box**
L125xW55xH183mm

 **Carton Box**
57.5x39.1x27.5cm

 **X 40PCS**



MAIN APPLICATIONS

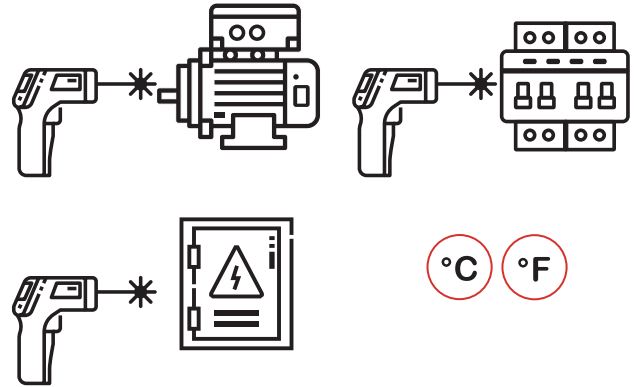

INFRARED THERMOMETER COLOR LCD
MS6531B

SKU NO.: MS6531BCBGLO
UPC CODE: 810053672969
EAN CODE: 8435394778693

FEATURE

- Color Display.
- Auto Power Off.
- Spectral Response 8-14 μ m.
- Laser <1mW/630-670nm.

SPECIFICATIONS

IRT Temperature -40°C~800°C/-40°F~1472°F	Repeatability ±0.1°C
Emissivity 0.10~1.00	

CONTENTS

176x132x49mm 6.9"x5.2"x1.9" 223g/0.5lb	1x9V 6F22 Battery
Carry bag Battery	Calibration Certificate
ACCESSORIES	Quick Start Guide

PACKAGING INFORMATION

Color Box L126xW58xH210mm	
Carton Box 44.5x34x28cm	X 20PCS



MAIN APPLICATIONS

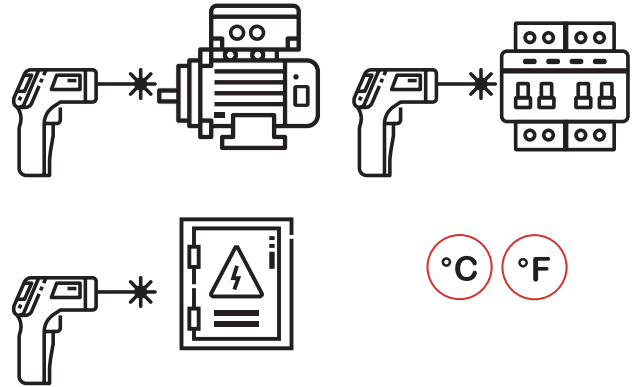

INFRARED THERMOMETER COLOR LCD
MS6531C

SKU NO.: MS6531CCBGLO
UPC CODE: 810053674284
EAN CODE: 8435394779355

FEATURE

- Color Display.
- Auto Power Off.
- Spectral Response 8-14 μ m.
- Laser <1mW/630-670nm.

SPECIFICATIONS

IRT Temperature -40°C~800°C/-40°F~1472°F	Repeatability ±0.1°C
K-Type Temperature -40°C~1080°C/-40°F~1976°F	Emissivity 0.10~1.00

CONTENTS

- 176x132x49mm
6.9"x5.2"x1.9"
223g/0.5lb
- 1x9V 6F22 Battery
- K type thermocouple
Carry bag
Battery
- Calibration Certificate
- Quick Start Guide

PACKAGING INFORMATION

- Color Box**
L126xW58xH210mm
- Carton Box**
44.5x34x28cm
- X 20PCS**



MAIN APPLICATIONS

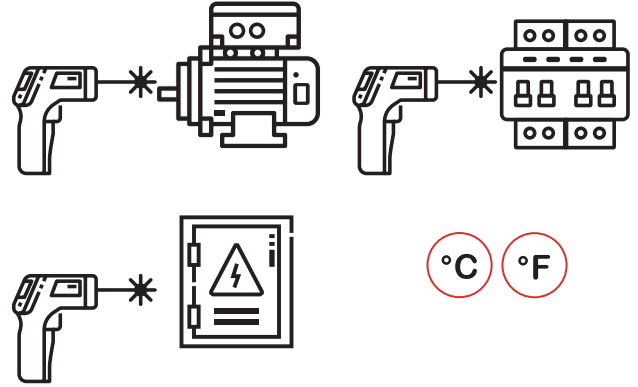

**INFRARED THERMOMETER
MS6541**

SKU NO.: MS6541CBGLO
UPC CODE: 810053674291
EAN CODE: 8435394779362

FEATURE

- Color Display.
- Auto Power Off.
- Spectral Response 8-14 μ m.
- Laser <1mW/630-670nm.

SPECIFICATIONS

IRT Temperature -50°C~760°C/-58°F~1400°F	Repeatability ±0.1°C
K-Type Temperature -50°C~300°C/-58°F~572°F	Emissivity 0.10~1.00

CONTENTS

- 192x95x83mm
7.5"x3.7"x3.3"
275g/0.6lb
- 1x9V 6F22 Battery
- K type thermocouple
Carry bag
Battery
- Calibration Certificate
- Quick Start Guide

PACKAGING INFORMATION

- Color Box**
L126xW58xH210mm
- Carton Box**
44.5x34x28cm
- X 20PCS**

ENVIRONMENTAL METERS

SOUND LEVEL METER | ANEMOMETER | LIGHT METER
MOISTURE TESTER | TACHOMETERS | GAS DETECTOR
MULTI-FUNCTIONS ENVIRONMENT TESTER | DISTANCE METERS
ELECTRONIC STUD METAL FINDER | VOLTAGE AND CURRENT
CALIBRATOR





DIGITAL SOUND LEVEL METER
MS6700

SKU NO.: MS6700CBGLO
UPC CODE: 810053676691
EAN CODE: 8435394784779

FEATURE

- Auto & Manual Ranging.
- Auto Power Off.
- Dynamic 50dB.
- Frequency 31.5Hz~8kHz.

SPECIFICATIONS

Sound Level 30dB~130dB	Frequency 31.5Hz~8KHz	Dynamic 50dB
Display Counts 2000		

MAIN APPLICATIONS

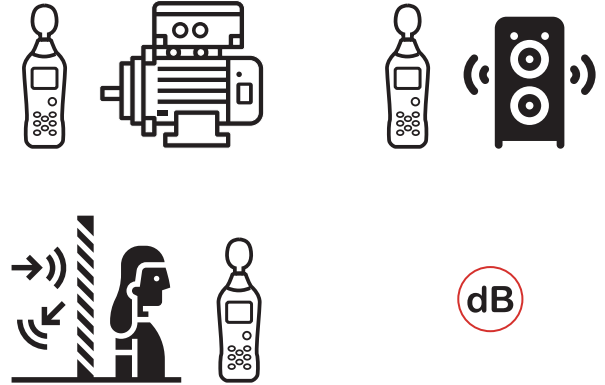

CONTENTS

	265x80x69mm 10.4"x3.15"x2.7" 317g/0.7lb		6x1.5V AAA Batteries
	Windscreen Earphone plug Wapping case Battery		Calibration Certificate
			Quick Start Guide

PACKAGING INFORMATION

	Color Box L160xW74xH295mm	
	Carton Box 38.5x32x34cm	X 10PCS



DIGITAL SOUND LEVEL METER
MS6701

SKU NO.: MS6701CBGLO
UPC CODE: 810053674321
EAN CODE: 8435394779393

FEATURE

- Auto & Manual Ranging.
- Auto Power Off.
- Dynamic 50dB.
- Frequency 31.5Hz~8kHz.

SPECIFICATIONS

Sound Level 30dB~130dB	Frequency 31.5Hz~8KHz	Dynamic 50dB
Data Recording 16000	Display Counts 2000	

MAIN APPLICATIONS

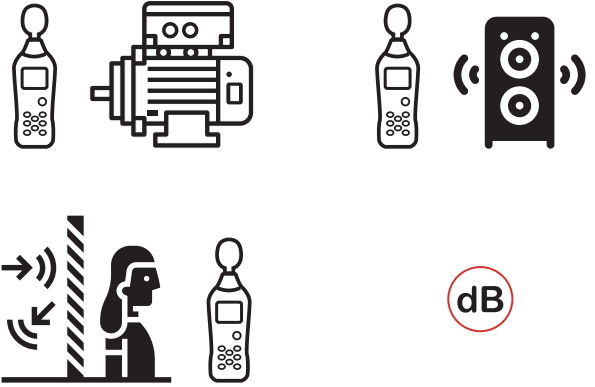

CONTENTS

	265x80x69mm 10.4"x3.15"x2.7" 317g/0.7lb		6x1.5V AAA Batteries
	Windscreen Earphone plug Wapping case USB Interface cable Software CD Battery		Calibration Certificate
			Quick Start Guide

PACKAGING INFORMATION

	Color Box L160xW74xH295mm	
	Carton Box 38.5x32x34cm	X 10PCS



DIGITAL SOUND LEVEL METER
MS6708

SKU NO.: MS6708CBGLO
UPC CODE: 810053674338
EAN CODE: 8435394779409

FEATURE

- Auto & Manual Ranging.
- Auto Power Off.
- Dynamic 50dB.
- Loudness Measurement..

SPECIFICATIONS

Sound Level 30dB~130dB	Frequency 10Hz~8kHz	Dynamic 50dB
Display Counts 2000		

MAIN APPLICATIONS

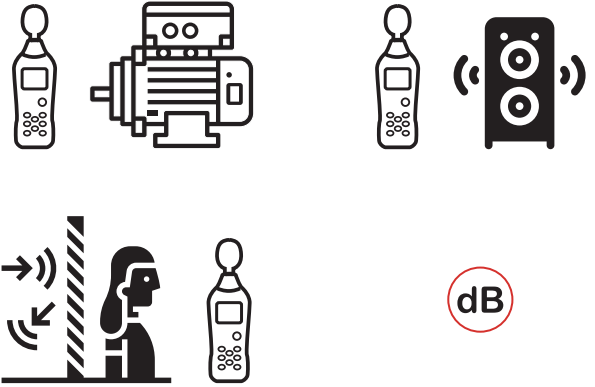

CONTENTS

193x60x29mm 7.6"x2.4"x1.1" 222g/0.48lb	4x1.5V AAA Batteries
Windscreen Carry bag Battery	Calibration Certificate
	Quick Start Guide

PACKAGING INFORMATION

Color Box L95xW45xH230mm	
Carton Box 49.5x27x41cm	X 40PCS



DIGITAL ANEMOMETER
MS6252A

SKU NO.: MS6252ACBGLO
UPC CODE: 810053672181
EAN CODE: 8435394777900

FEATURE

- Display 9999 Counts With Backlight.
- Flow Area Setting.
- MAX/MIN.
- Data Hold.

SPECIFICATIONS

m/s 0.80~40.00m/s	km/h 2.88~144.0km/h	ft/s 2.62~131.2ft/s
Knots 1.6~77.70knots	mile/h 1.8~90.00mil/h	ft/m 157.5~7874ft/m
Display Counts 9999		

MAIN APPLICATIONS

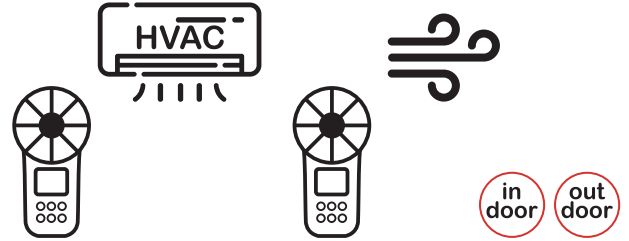

CONTENTS

	165×85×38mm 6.5"×3.3"×1.5" 168g/0.37lb		1×9V 6F22 Battery
	Carry bag Battery		Calibration Certificate
	Detector bracket (optional)		Quick Start Guide

PACKAGING INFORMATION

	Color Box L110×W60×H190mm	
	Carton Box 40×33.5×24cm	X 20PCS



DIGITAL ANEMOMETER
MS6252B

SKU NO.: MS6252BCBGLO
UPC CODE: 810053673096
EAN CODE: 8435394778822

FEATURE

- USB Interface.
- Display 9999 Counts With Backlight.
- Temperature Mode.
- MAX/MIN/Data Hold.

SPECIFICATIONS

m/s 0.80~40.00m/s	km/h 2.88~144.0km/h	ft/s 2.62~131.2ft/s
Knots 1.6~77.70knots	mile/h 1.8~90.00mil/h	ft/m 157.5~7874ft/m
Temperature -10°C~60°C/14°F~140°F		Display Counts 9999

MAIN APPLICATIONS

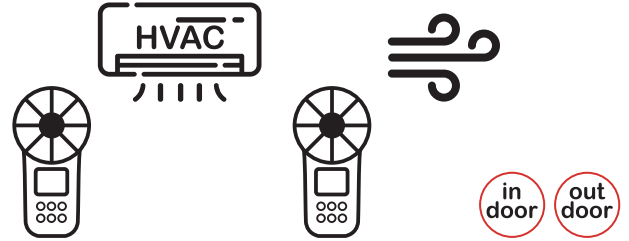

CONTENTS

	165×85×38mm 6.5"×3.3"×1.5" 168g/0.37lb		1×9V 6F22 Battery
	Carry bag Battery USB interface cable Software CD		Calibration Certificate
	Detector bracket (optional)		Quick Start Guide

PACKAGING INFORMATION

	Color Box L110×W60×H190mm	
	Carton Box 40×33.5×24cm	X 20PCS



DIGITAL ANEMOMETER
MS6252D

SKU NO.: MS6252DCBGLO
UPC CODE: 810053676813
EAN CODE: 8435394785349

FEATURE

- Wireless Interface.
- Display 9999 Counts With Backlight.
- Temperature Mode.
- MAX/MIN/Data Hold.

SPECIFICATIONS

m/s 0.80~40.00m/s	km/h 2.88~144.0km/h	ft/s 2.62~131.2ft/s
Knots 1.6~77.7knots	mile/h 1.8~90.00mil/h	ft/m 157.5~7874ft/m
Temperature -10°C~60°C/14°F~140°F		Display Counts 9999

MAIN APPLICATIONS

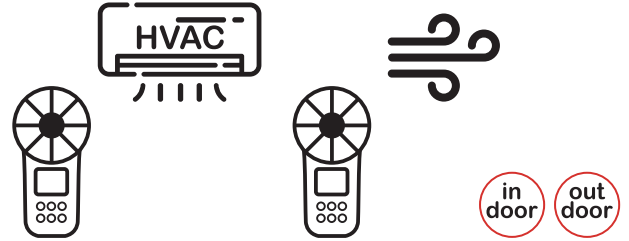

CONTENTS

	165×85×38mm 6.5"×3.3"×1.5" 168g/0.37lb		1×9V 6F22 Battery
	Carry bag Battery		Calibration Certificate
	Detector bracket (optional)		Quick Start Guide

PACKAGING INFORMATION

	Color Box L110×W60×H190mm	
	Carton Box 40×33.5×24cm	X 20PCS



DIGITAL LIGHTMETER [LUX]
MS6610

SKU NO.: MS6610CBGLO
UPC CODE: 810053673058
EAN CODE: 8435394778785

FEATURE

- Data Hold.
- Silicon Photo Diode with Filter Photo Detector.
- Lead Length 150cm (Approx).
- Low Battery Indicator.

SPECIFICATIONS

LUX Ranging 50,000	Display Counts 2000
------------------------------	-------------------------------

MAIN APPLICATIONS



CONTENTS

	126×72×27mm 5.0"×2.8"×1.0" 180g/0.4lb	Detector Size: 83×52×21mm 3.2"×2.0"×0.8"
ACCESSORIES	Carry bag Battery	1×9V 6F22 Battery
	Calibration Certificate	QSG Quick Start Guide

PACKAGING INFORMATION

	Color Box L115×W55×H165mm	
	Carton Box 48×34×31.5cm	X 40PCS



DIGITAL LIGHTMETER [LUX/FC]
MS6612

SKU NO.: MS6612CBGLO
UPC CODE: 810053674307
EAN CODE: 8435394779379

FEATURE

- Relative Measurement.
- Peak Measurement.
- Zero Calibration.
- LUX & FC unit selection.

SPECIFICATIONS

LUX Ranging 200,000	FC Ranging 20,000	Display Counts 2000
-------------------------------	-----------------------------	-------------------------------

MAIN APPLICATIONS

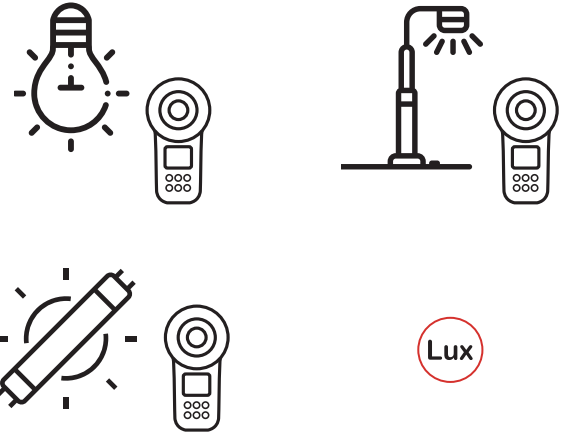

CONTENTS

	170×89×43mm 6.7"×3.5"×1.7" 420g/0.93lb		1×9V 6F22 Battery
	Carry bag Battery		Calibration Certificate
			Quick Start Guide

PACKAGING INFORMATION

	Color Box L110×W60×H190mm	
	Carton Box 40×33.5×24cm	X 20PCS



DIGITAL LIGHTMETER [LUX/FC/CD]
MS6612B

SKU NO.: MS6612BCBGLO
 UPC CODE: 810053674314
 EAN CODE: 8435394779386

FEATURE

- Relative Measurement.
- Peak Measurement.
- Zero Calibration.
- LUX, FC & CD unit selection.

SPECIFICATIONS

CD Ranging 999,900	LUX Ranging 200,000	FC Ranging 20,000
Display Counts 2000		

MAIN APPLICATIONS

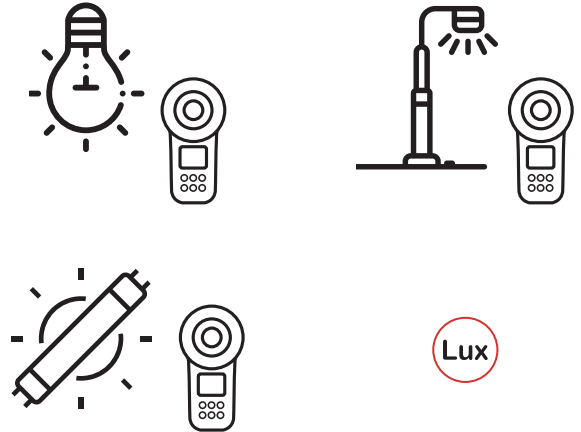

CONTENTS

170×89×43mm 6.7"×3.5"×1.7" 420g/0.93lb	1×9V 6F22 Battery
Carry bag Battery	Calibration Certificate
ACCESSORIES	Quick Start Guide

PACKAGING INFORMATION

Color Box L110×W60×H190mm	
Carton Box 40×33.5×24cm	X 20PCS



DIGITAL LIGHTMETER [LUX/FC/CD]
MS6612D

SKU NO.: MS6612DCBGLO
UPC CODE: 810053676820
EAN CODE: 8435394785356

FEATURE

- Relative Measurement.
- Peak Measurement.
- Zero Calibration.
- LUX, FC & CD unit selection.

SPECIFICATIONS

CD Ranging 999,900	LUX Ranging 200,000	FC Ranging 20,000
Display Counts 2000		

MAIN APPLICATIONS

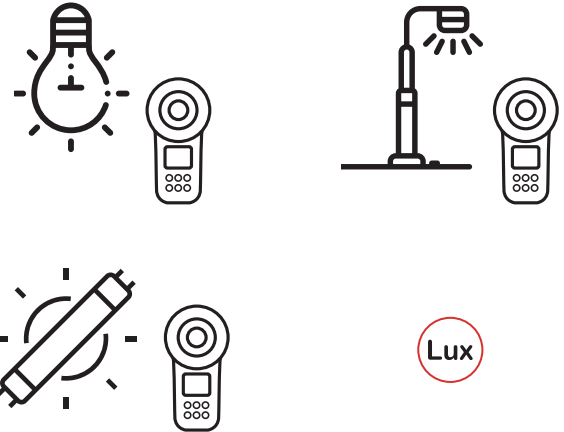

CONTENTS

170x89x43mm 6.7"x3.5"x1.7" 420g/0.93lb	1x9V 6F22 Battery
Carry bag Battery	Calibration Certificate
ACCESSORIES	Quick Start Guide

PACKAGING INFORMATION

Color Box L110xW60xH190mm	
Carton Box 40x33.5x24cm	X 20PCS



MOISTURE TESTER
MS6900

SKU NO.: MS6900CBGLO
 UPC CODE: 810053674376
 EAN CODE: 8435394779447

FEATURE

- Verification Test Points.
- Depth 0~5mm.
- Sampling Rate 240ms.
- Unit Selection %, WB, TD, °C, °F, %RH.

SPECIFICATIONS

Material Moisture 0.0~60.0%	Ambient TEMP -10°C~50°C/14°F~122°F
Relative Humidity 10~90%	

MAIN APPLICATIONS

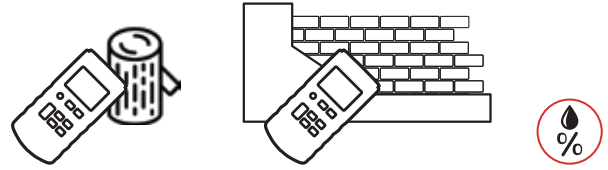

CONTENTS

	130×56×29mm 5.1"×2.2"×1.1" 120g/0.26lb		2×1.5V AAA Batteries
	Carry bag Battery		Calibration Certificate
	ACCESSORIES		Quick Start Guide

PACKAGING INFORMATION

	Color Box L75×W55×H155mm	
	Carton Box 61×33×25cm	X 60PCS



MAIN APPLICATIONS

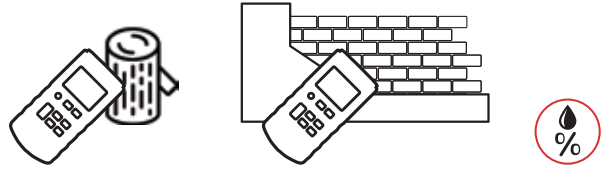

CONTENTS



130×56×29mm
5.1"×2.2"×1.1"
120g/0.26lb



2×1.5V AAA
Batteries



Carry bag
Battery

ACCESSORIES



Calibration
Certificate



Quick Start
Guide

PACKAGING INFORMATION



Color Box
L75×W55×H155mm



Carton Box
61×33×25cm



X 60PCS

MOISTURE TESTER

MS6900A

SKU NO.: MS6900ACBGLO
UPC CODE: 810053675298
EAN CODE: 8435394783314

FEATURE

- Verification Test Points.
- Depth 0~5mm.
- Sampling Rate 240ms.
- Unit Selection %, WB, TD, °C, °F, %RH.

SPECIFICATIONS

Material Moisture
0.0~60.0%

Ambient TEMP
-10°C~50°C/14°F~122°F

Relative Humidity
10~90%



MAIN APPLICATIONS

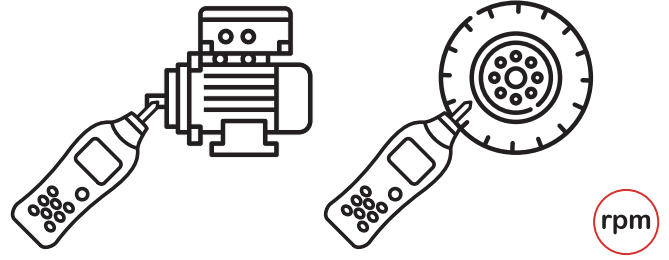

CONTENTS



170×60×27mm
6.7"×2.4"×1.1"
130g/0.28lb



4×1.5AAA
Batteries



ACCESSORIES

Measurement idler wheels
Touch tips
Lengthening bar
Carry bag
Battery



Calibration Certificate



Quick Start Guide

DIGITAL TACHOMETER (Contact)
MS6208A

SKU NO.: MS6208ACBGLO
UPC CODE: 810053672167
EAN CODE: 8435394777887

FEATURE

- Contact Measuring Mode.
- Unit Selection m/min, m/sec, ft/min, ft/sec, in/min
- Auto Power Off.

SPECIFICATIONS

Ranging (contact)
50~19,999RPM

PACKAGING INFORMATION



Color Box
L95×W45×H195mm



Carton Box
41.5×27×41cm



X 40PCS



DIGITAL TACHOMETER (Non-Contact)

MS6208B

SKU NO.: MS6208BCBGLO
 UPC CODE: 810053672174
 EAN CODE: 8435394777894

FEATURE

- Non-Contact Measuring Mode.
- Measuring Distance 50mm~250mm.
- Auto Power Off.
- MAX/MIN.

SPECIFICATIONS

Ranging (non-contact)
50~99,999 RPM

MAIN APPLICATIONS

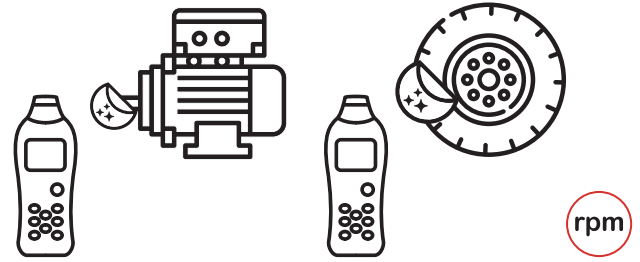

CONTENTS



155×60×27mm
 6.1"×2.4"×1.1"
 120g/0.26lb



4×1.5 AAA
 Batteries



ACCESSORIES

Reflective sheetin
 Carry bag
 Battery



Calibration
 Certificate



Quick Start
 Guide

PACKAGING INFORMATION



Color Box
 L95×W45×H195mm



Carton Box
 41.5×27×41cm



X 40PCS



COMBUSTIBLE GAS DETECTOR
MS6310

SKU NO.: MS6310CBGLO
UPC CODE: 810053672334
EAN CODE: 8435394778242

FEATURE

- Easy to Identify and Pinpoint Gas Leaks.
- Portable and High Sensitivity.
- Resume Original Measurement State After 7~10 Minutes in Clear Air.

SPECIFICATIONS

Resolution
50ppm

Alarm
10%~40%

MAIN APPLICATIONS



CONTENTS



172×70×465mm
6.8"×2.8"×1.8"
354g/0.78lb



4×1.5 AA
Batteries



Carry bag
Battery



Calibration
Certificate

ACCESSORIES



Quick Start
Guide

PACKAGING INFORMATION



Color Box
L130×W63×H255mm



Carton Box
53×34×28.5mm



X 20PCS



MULTI-FUNCTIONS ENVIRONMENT TESTER
MS6300

SKU NO.: MS6300CBGLO
UPC CODE: 810053672594
EAN CODE: 8435394778235

FEATURE

- AVG / MAX / MIN / DIF (MAX-MIN)
- A/C Weighting Indication.
- Data Hold.
- Display Backlight.

SPECIFICATIONS

Sound Level 30~130dB(A)	Luminance 0~50,000LUX	Wind Speed 0.5~20m/s
Air Flow 999,900CMM/CFM		Humidity 20~80%RH
Temperature -10°C~60°C/14°F~140°F		

MAIN APPLICATIONS

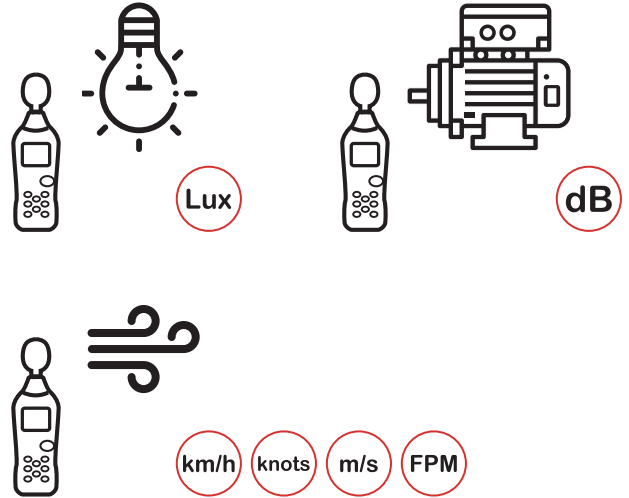

CONTENTS

- 280x89x50mm
11.0"x3.5"x2.0"
433g/0.95lb
- 1x9V 6F22 Battery
- Windbreak Holder
Holder
Wrapping case
Battery
- Calibration Certificate
- Quick Start Guide

PACKAGING INFORMATION

- Color Box**
L325xW80xH160mm
- Carton Box**
42x35x35cm
- X 10PCS**



MAIN APPLICATIONS



CONTENTS



160×74×42mm
6.3"×2.9"×1.65"
154g/0.33lb



1×9V 6F22
Battery



Battery

ACCESSORIES



Calibration
Certificate



Quick Start
Guide

ELECTRONIC STUD METAL FINDER

MS6906

SKU NO.: MS6906CBGLO
UPC CODE: 810053674574
EAN CODE: 8435394779645

FEATURE

- Auto Power Off.
- Low Battery Display.
- Display Backlight, Work Light.

SPECIFICATIONS

Wooden Pillar
30mm

Metal Stud Detection Depth
30mm

Metal Pipe Detector Depth
50mm

AC Voltage Detector Depth(50~600VAC)
75mm

PACKAGING INFORMATION



Color Box
L145×W60×H188mm



Carton Box
40×32×31.5cm



X 20PCS



MAIN APPLICATIONS

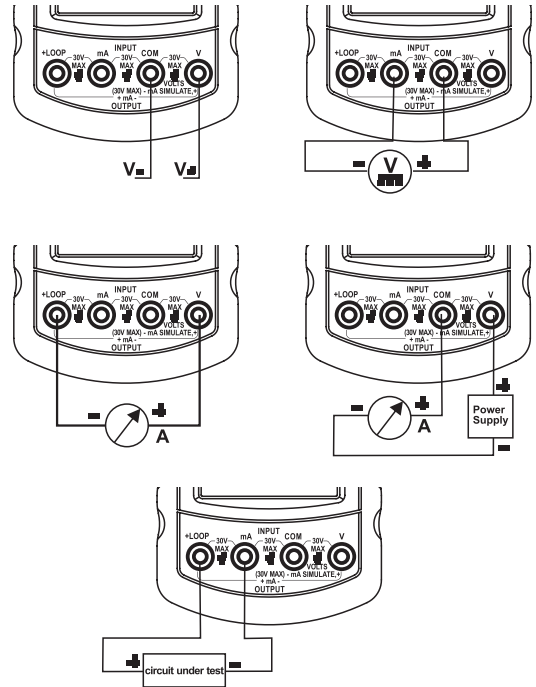

VOLTAGE AND CURRENT CALIBRATOR
MS7221

SKU NO.: MS7221CBGLO
UPC CODE: 810053672020
EAN CODE: 8435394777757

FEATURE

- Selection of Absolute or Percentage Value in Amp Mode
- Calibration and Simulation of External Transducers
- LOOP Mode

SPECIFICATIONS

DC Voltage (Input/Output) 0~100mV, 0~10V	DC Current 0~24mA
DC Voltage (Loop) 0~24V	

CONTENTS

- 190×89×42mm
7.5"×3.5"×1.7"
350g/0.77lb
- 1×9V 6LR61 Battery
- Test leads
- Wapping case
- Battery
- Calibration Certificate
- QSG Quick Start Guide

PACKAGING INFORMATION

- Color Box**
L188×W88×H264mm
- Carton Box**
47×31×39.5cm
- X 10PCS**

TEST LEADS

T3009U



SKU NO..	UPC CODE	EAN CODE
T3009UPEGLO		
- Probe Length: 146mm/ø10.2mm Right Angle Type, M4 screw - Length: 1200mm - Tip: ø2mm		- Plug: ø4.5mm - Wire: UL 1803/18AWG - MAX 10A

TEST LEADS

T3030U

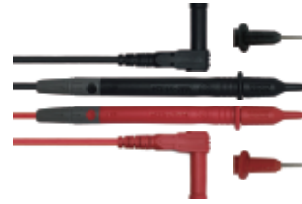

SKU NO..	UPC CODE	EAN CODE
T3030UPEGLO	810053672778	8435394778419
- Probe Length: 143mm/ø10mm - Length: 1000mm - Tip: ø2mm		- Plug: ø4.5mm - Wire: UL 1803/18AWG - MAX 10A

TEST LEADS

T3016U



SKU NO..	UPC CODE	EAN CODE
T3016UPEGLO	810053674000	8435394779072
- Probe Length: 132mm/ø10mm Right Angle Type, M4 screw - Length: 1000mm - Tip: ø2mm		- Plug: ø4.5mm - Wire: UL 1803/18AWG - MAX 10A

TEST LEADS

T3033U

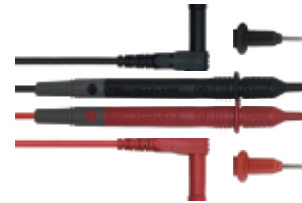

SKU NO..	UPC CODE	EAN CODE
T3033UPEGLO	810053672785	8435394778426
- Probe Length: 119mm/ø9mm - Length: 800mm - Tip: ø2mm		- Plug: ø4.5mm - Wire: UL 1803/20AWG - MAX 10A

TEST LEADS

T3022



SKU NO..	UPC CODE	EAN CODE
T3022PEGLO	810053674017	8435394779089
- Straight Type & Right Angle Type - Length: 1000mm - Plug: ø4.5mm		- Wire: UL 1803/18AWG - MAX 10A

TEST LEADS

T3060A



SKU NO..	UPC CODE	EAN CODE
T3060APEGLO	810053674819	8435394783482
- Probe Length: 132mm/ø10mm Right Angle Type, M4 screw - Length: 1000mm - Tip: ø2mm		- Plug: ø4.5mm - Wire: UL 1803/18AWG - MAX 10A

TEST LEADS

T3060B

SKU NO..	UPC CODE	EAN CODE
T3060BPEGLO	810053674826	8435394779881

- Probe Length: 132mm/ø10mm
- Right Angle Type, M4 screw
- Length: 1500mm
- Tip: ø2mm
- Plug: ø4.5mm
- Wire: UL 1803/18AWG
- MAX 10A

TEST LEADS

T3103

SKU NO..	UPC CODE	EAN CODE
T3103PEGLO	810053674024	8435394779096

- Straight Type
- Length: 1340mm
- Plug: ø4.5mm
- Wire: UL 1803/18AWG
- MAX 10A

Big Mouth Alligator Clip

C3107

SKU NO..	UPC CODE	EAN CODE
C3107PEGLO	810053674031	8435394779102

- Length: 87mm
- ø4mm cross plug
- Max 32A

Alligator Clip

C3109A

SKU NO..	UPC CODE	EAN CODE
C3109APEGLO	810053674901	8435394782355

- Length: 61.5mm
- with M4 screw

Medium Alligator Clip

C3109B

SKU NO..	UPC CODE	EAN CODE
C3109BPEGLO	810053673249	8435394778723

- Length: 55mm
- with M4 screw

IC Test Clip

C3112

SKU NO..	UPC CODE	EAN CODE
C3112PEGLO	810053675014	8435394783451

- Length: 185mm
- Plug: ø4mm Jack
- Max 5A

THERMOCOUPLES
P3400



SKU NO..	UPC CODE	EAN CODE
P3400PEGLO	810053676752	8435394779867

- Length:1000mm
- Ranging:-40~260°C(-40~500°F)

THERMOCOUPLES
P3408A



SKU NO..	UPC CODE	EAN CODE
P3408APEGLO	810053675410	8435394783482

- Length:1000mm
- Ranging:-40~260°C(-40~500°F)
- Plug lenth : 12mm

THERMOCOUPLES
P3401



SKU NO..	UPC CODE	EAN CODE
P3401PEGLO	810053674888	8435394782096

- Length:1000mm
- Ranging:-40~260°C(-40~500°F)

THERMOCOUPLES
P3409A



SKU NO..	UPC CODE	EAN CODE
P3409APEGLO	810053675434	8435394783505

- Length:1000mm
- Ranging:-40~800°C(-40~1472°F)
- Plug lenth : 12mm

THERMOCOUPLES
P3408B



SKU NO..	UPC CODE	EAN CODE
P3408BPEGLO	810053675427	8435394783499

- Length:1000mm
- Ranging:-40~260°C(-40~500°F)
- Plug lenth : 16mm

THERMOCOUPLES
P3409B



SKU NO..	UPC CODE	EAN CODE
P3409BPEGLO	810053674802	8435394779867

- Length:1000mm
- Ranging:-40~800°C(-40~1472°F)
- Plug lenth : 16mm

THERMOCOUPLES

P3410

SKU NO..	UPC CODE	EAN CODE
P3410PEGLO	810053675441	8435394783512

- Length:1000mm
- Ranging:-40~600°C(-40~1112°F)

THERMOCOUPLES

P3412

SKU NO..	UPC CODE	EAN CODE
P3412PEGLO	810053675458	8435394783529

- Length:1000mm
- Ranging:-40~260°C(-40~500°F)

MASTECH®

www.mastech-group.com



AMERICAS

MGL America, Inc.

✉ cs.na@mgl-intl.com

6509 Northpark Blvd Unit 400,

Charlotte, NC 28216 USA

Tel: +1 833 533-5899

APAC

MGL APPA Corporation

✉ cs.apac@mgl-intl.com

Flat 4-1, 4/F, No. 35, Section 3

Minquan East Road, Taipei, Taiwan

Tel: +886 2-2508-0877

EMEA

MGL Euman S.L.

✉ cs.emea@mgl-intl.com

C/ Picu Castiellu, Parcelas i1-i4

Argame, Morcin 33163, Asturias, Spain

Tel: +36 985-08-18-70

MEXICO & LATAM

MGL LATAM SA DE CV

✉ cs.latam@mgl-intl.com

Colonia Industrial Vallejo Del.

Azcapotzalco 02300, Mexico DF

Tel: +1 883-533-5899

UNITED KINGDOM

POWER PROBE GROUP LIMITED

✉ cs.uk@mgl-intl.com

14 Weller St, London, SE1 1QU, UK

Tel: +34 985-08-18-70